

making a difference

BIOSCIENCE

CATALOGUE

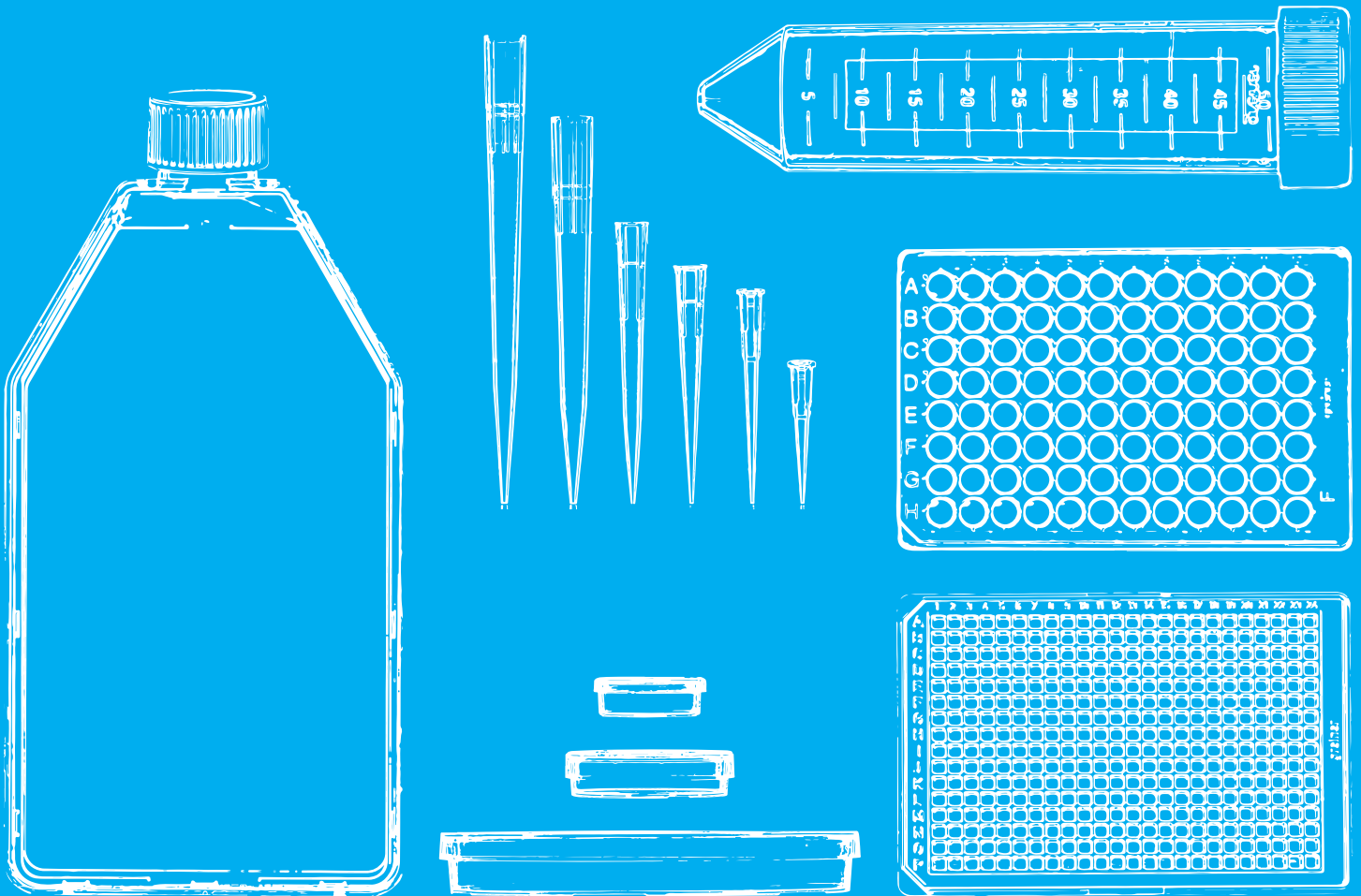

UK EDITION 2024

www.gbo.com

greiner
BIO-ONE

making a difference



To us, health is the highest personal priority. This inspires our daily mission of serving life sciences and healthcare professionals with advanced and sustainable products and solutions.

It is the passion and commitment of our employees employees that makes the difference. With a targeted approach, our global team continuously strives for excellence and works closely with our customers.

We empower people to make a difference in health.

CONTENT

6

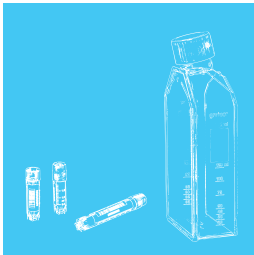

BIOSCIENCE

Making a difference in research and science

8

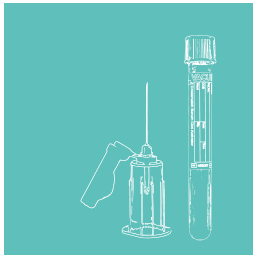

PREANALYTICS

Preanalytical specimen collection systems and safety solutions

10

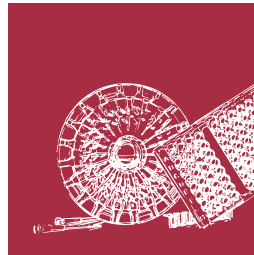

OEM

Tailor made solutions

12



SERVICE

Fast. Secure. Efficient. E-Commerce Solutions from Greiner Bio-One

16



QUALITY

Products for the highest quality demands

22



CUSTOMER FOCUS

At your doorstep, across the world

252



TECHNICAL APPENDIX

285



NUMERICAL INDEX

BIOSCIENCE

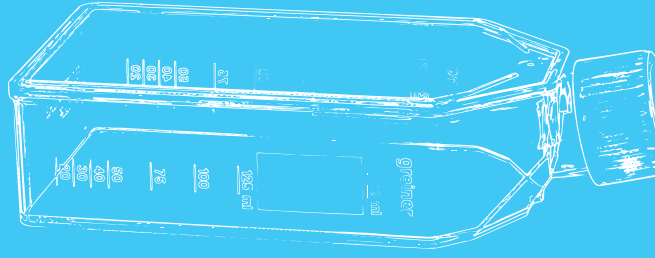
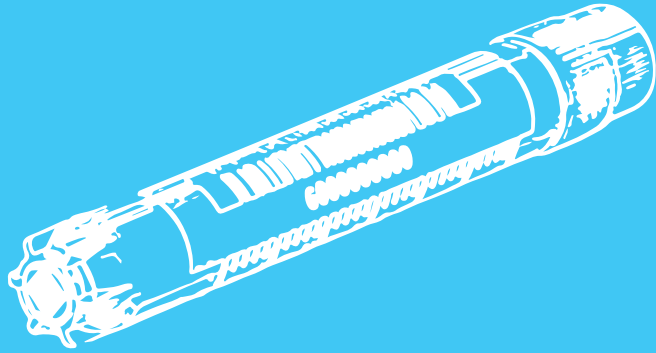
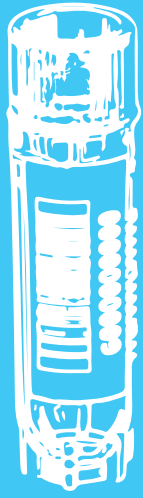

MAKING A DIFFERENCE IN RESEARCH AND SCIENCE

Greiner Bio-One is one of the leading suppliers of special products for the cultivation and analysis of cell and tissue cultures. Under the brand name CELLSTAR®, we offer cell culture flasks, dishes and plates in a wide variety of formats and surface modifications, so that you will always find exactly the right product for every application and all cell types.

In addition, we have been developing and producing microplates for high-throughput screening for more than 60 years, enabling

industry and research to carry out fast and efficient drug testing. Among other things, Greiner Bio-One was the first manufacturer to introduce a microplate in 1536 well format to the market, setting new standards in terms of automation, performance and cost reduction.

Based on decades of experience in the cryogenic storage of samples, we also offer comprehensive solutions for automated storage systems in biobanks.

- / High-quality products for your lab**
- / Special products for cell and tissue culture**
- / Microplates for industry and research**
- / Cryogenic storage systems**

PREANALYTICS

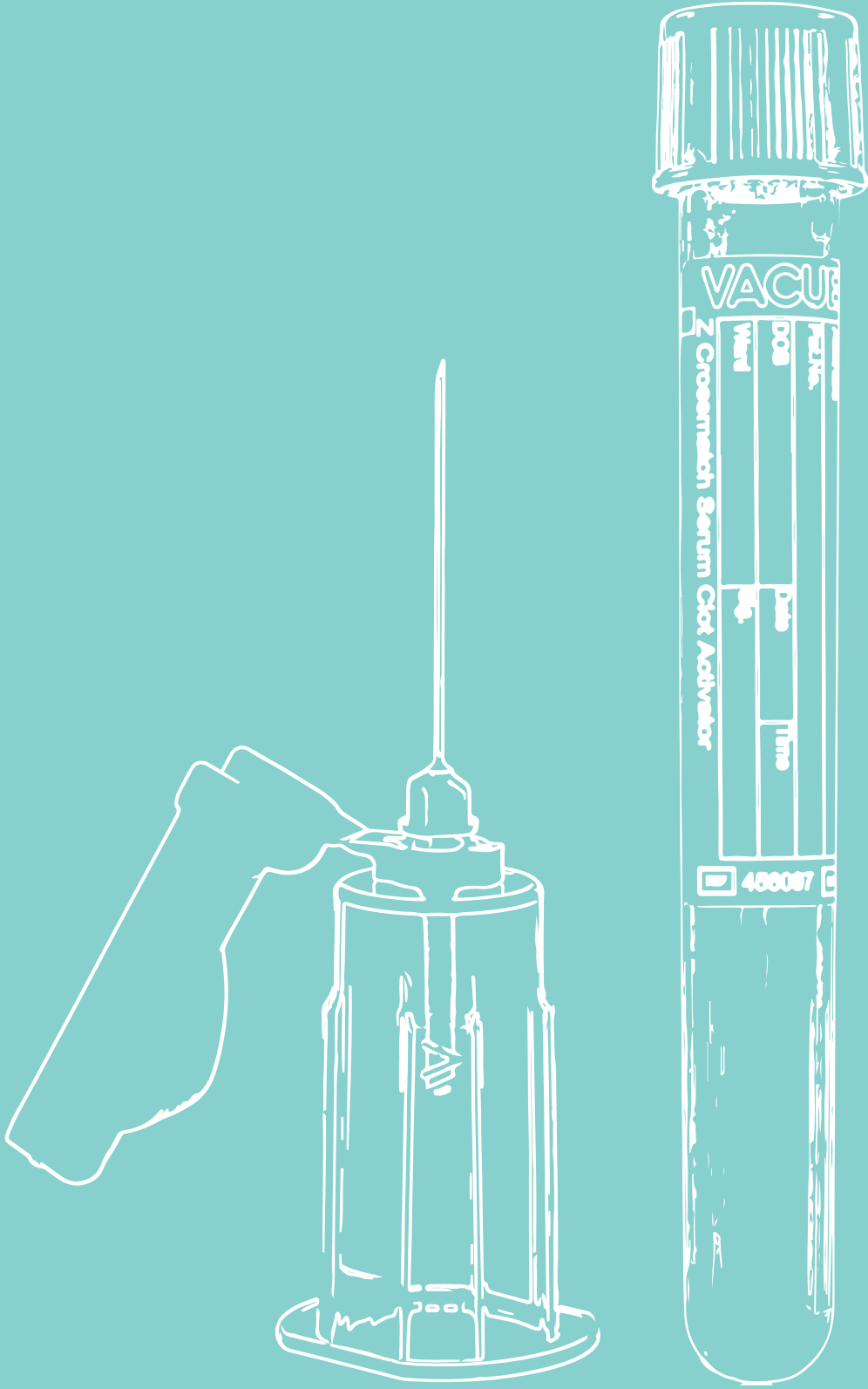

PREANALYTICAL SPECIMEN COLLECTION SYSTEMS AND SAFETY SOLUTIONS

Greiner Bio-One was the first company in the world to successfully launch a blood collection system made out of virtually unbreakable PET plastic including a safety cap. Many components of the VACUETTE® System have often been copied, but never reached our high quality standards.

As a trendsetter in the field

of sample collection, we offer solutions that meet the highest demands of our customers. Because your work is an important contribution to health protection.

Continuously new and improved product solutions, perfect functionality, maximum safety and high product quality are the result of decades of experience.

- / Provide safety
- / Simplify handling
- / Provide support
- / Increase efficiency
- / Save costs

OEM

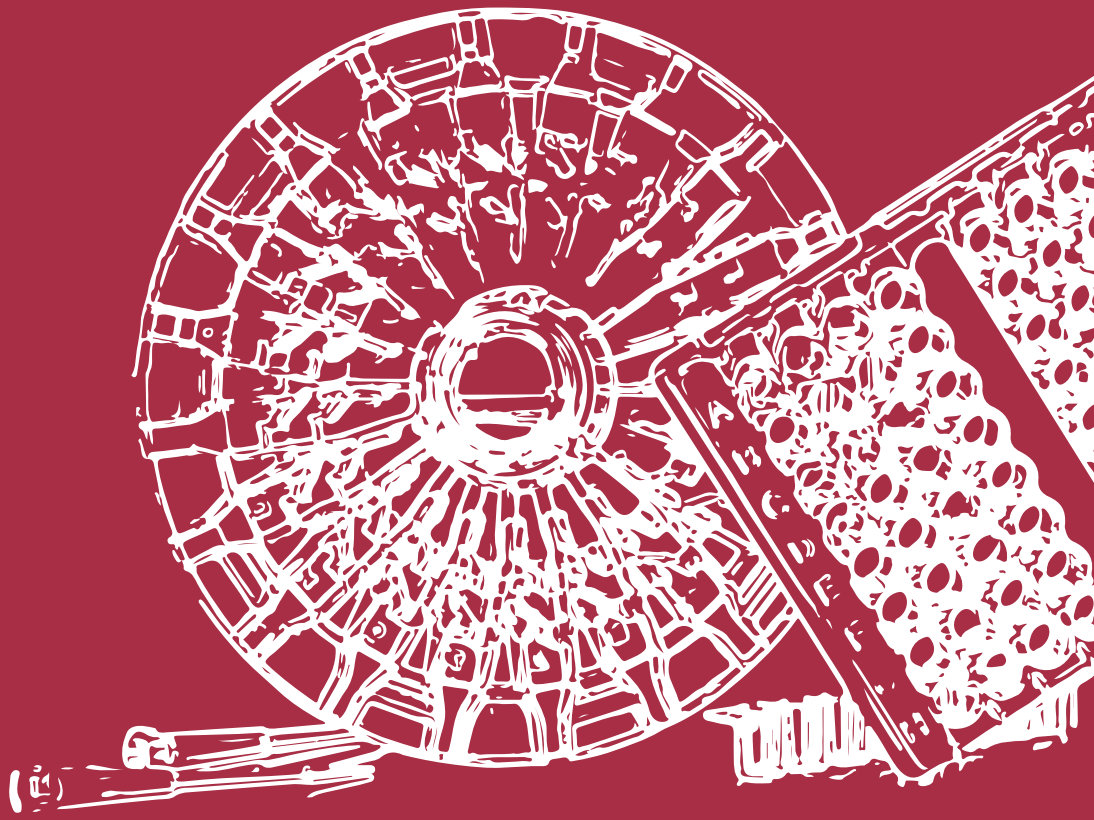

TAILOR MADE SOLUTIONS

Greiner Bio-One as an Original Equipment Manufacturer (OEM) is a long-term partner of the pharmaceutical industry, biotechnology, diagnostic and medical technology industries. The company manufactures numerous products through injection moulding and offers the entire product development and production process. From design,

via prototyping, through fully automated manufacturing, Greiner Bio-One delivers the complete solution with support of experienced scientists, engineers and specialists.

With a global sales network specifically established for the field of OEM, Greiner Bio-One offers custom-made solutions with personal service.

- / Research & development with diverse application and research laboratories**
- / Construction of moulds, planning of plants and assembly lines**
- / Modern, fully automated production**
- / Post-production according to customer requirements**
- / Comprehensive quality assurance and management system**
- / Worldwide networked warehousing and customer service**



FAST. SECURE. EFFICIENT. E-COMMERCE SOLUTIONS FROM GREINER BIO-ONE

As your strong partner in the fields of biotechnology, diagnostics, medical devices and research, Greiner Bio-One already provides you with solutions on a daily basis. In addition, we can offer you a wide selection of e-business solutions to ensure the optimal integration of our products and services into your purchasing process. That in turn will significantly reduce your process-related costs and warehouse costs.

Take advantage of e-business connectivity and make your processes faster, more secure and more efficient.

Greiner Bio-One offers you numerous solutions and the necessary expertise to support your processes, regardless of which ERP system you use. Would you like to purchase via our online shop or are you interested in one of our eProcurement solutions such as EDI or OCI?

In order to stay informed, you can subscribe to our Greiner Bio-One Newsletter and never miss any news about our products and events.



- / Online-Shop
- / EDI (Electronic Data Interchange)
- / OCI (Open Catalogue Interface)
- / Electronic catalogues



Subscribe to our newsletter
and never miss
the latest news!

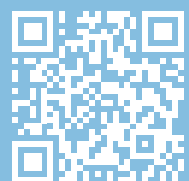

As scientists, we
share your passion for
your research success.
We are happy to support you
wherever and whenever
we are needed.



TRUE TRUST

Take advantage of our experience and passion for your projects and tasks

WE KEEP OUR PROMISES

For us, real trust means keeping promises. This is one of the core values that we are committed to as a company, both towards you as our customers and towards our employees.

As a family-owned company, we believe that trusting, active partnership is the key to sustainable and reliable processes. We

understand your requirements, speak your language and are happy to support you in advancing your scientific progress. We are at your side at every stage – our competent team of experts is always on hand, from the first contact and flawless delivery of our products, to all forms of after-sales service.



PUT YOUR TRUST IN US:

- / Partner for sustainable and reliable processes
- / 60 years of experience in science and healthcare
- / Innovation with tradition
- / Support during every work step



DISCOVER MORE:



With state-of-the-art technology,
we develop high-performance
solutions for consistent,
reproducible results that
you can always rely on.



QUALITY

Reproducible results
you can rely on

CONSISTENTLY HIGH QUALITY FOR RELIABLE RESULTS

Quality has been our top priority for 60 years. This applies all over the world, as all of our production facilities are committed to the same high standard.

Our products are made from strictly controlled, certified raw materials. With state-of-the-art production technology and

continuous in-process checks by specially trained employees, we ensure consistent quality of the products. Quality promise not only relates to the manufacturing process and therefore to product quality, but to every process and every interaction with you. We are ISO 9001 and ISO 13485 certified.



CONSISTENT HIGH QUALITY:

- / Location-independent
- / State-of-the-art manufacturing technologies
- / Controlled and certified raw materials
- / ISO 9001 and ISO 13485 certified



DISCOVER MORE:





Thanks to our presence in over 100 countries, you can rely on us to provide you with consistent high quality, availability and support. Wherever you are.

GLOBAL PRESENCE

There to support you
- wherever you are

ON-SITE FOR YOU WORLDWIDE

By global presence we mean being there for you whenever and wherever you need us.

Our seven production sites in Europe, Asia and North and South America meet the same high quality standards and

ensure low-risk delivery routes and a secure product supply. The support teams of our 28 offices and distributors in more than 100 countries are helpful and competent, and are always on hand when you need help or support.



WE PLACE IMPORTANCE ON:

- / **Competent local support**
- / **Optimum product availability**
- / **Consistent high quality worldwide**



DISCOVER MORE:



A man with a shaved head and glasses, wearing a light blue button-down shirt, is standing in front of a whiteboard. He is holding a black marker in his right hand and is in the process of drawing a lightbulb on the whiteboard. The lightbulb is drawn with dark green lines. The background is a blurred office setting with wooden paneling and a window. The text is overlaid on the right side of the image, in white font on a dark teal background.

Our innovative spirit
supports the results of
your pioneering work.
In the past, present
and future.

STATE- OF-THE-ART TECHNOLOGY

Pioneers for
progress

IDEAS BECOME SOLUTIONS

For more than 60 years, our passion for plastic technology and manufacturing processes has driven us to constantly innovate to support you optimally in your daily work and ensure your success.

We have been instrumental in the development of consumables in the diagnostics and life sciences industries, as well as in the medical market, since 1963.

We are proud of our rich pioneering history – from the production of the first plastic petri dishes, to Europe’s first plastic vacuum sampling system or the invention of the world’s first 1536-well microplates. We will continue to strive for new and innovative product solutions that are precisely tailored to your requirements and optimally support you in your daily work.



PROGRESS NEEDS PIONEERS:

- / Product solutions for current and emerging trends
- / Innovative production technologies



DISCOVER MORE:



We work hand in hand with you to
develop tailored solutions to suit
your requirements.



CUSTOMER FOCUS

We focus on you and your goals

WE SUPPORT YOU SO WE CAN MAKE BIG THINGS HAPPEN TOGETHER

Everything we do and the way we do it is designed to make your work easier. By understanding your wishes and needs, as well as your requirements and workflows, we are able to offer you real added value and thus trust in long-term and sustainable customer relationships.

We are here to provide you with the best products and solutions

to suit your needs. Our dedicated team ensures that processes run smoothly and is always on hand when needed. Our multidisciplinary teams have many years of practical experience in science and laboratory work and understand the challenges of your daily work first hand. We are happy to use this expert knowledge to create training materials tailored to your specific needs.



WE OFFER:

- / Long-term customer relationship
- / Solutions to suit your requirements
- / Training and training materials



DISCOVER MORE:



We use over 60 years of experience
in the laboratory and healthcare
sectors, and our passion
for innovation, to meet your
requirements and grow with you.



EXPERTISE

In all relevant market trends

WE SPEAK YOUR LANGUAGE

We understand your tasks and their workflows with all their requirements. Our experts are at your side with more than 60 years of experience – from the development of products and solutions to support with regulatory issues or individual training.

More than 80% of our sales and application specialists have a background in natural sciences

and practical experience in the laboratory. We would be happy to advise you on site – at the place where your requirements arise. You can rely on our expertise to quickly integrate our products into your processes, because we know and understand your workflow. We are happy to support you in every step of your individual workflow, for example with product training, support documentation and service.



WHAT WE OFFER:

- / Comprehensive portfolio for your workflow needs
- / Experienced team of industry experts
- / Best practices for optimal efficiency



DISCOVER
MORE:



We help you to optimize your operations and processes so that you can always achieve the best possible results.



EFFICIENCY

We are your partner
for increasing
efficiency – inside
and outside the
laboratory

WE INCREASE YOUR EFFICIENCY

In the laboratory and day-to-day work, increasing efficiency is no longer just an option, but an essential requirement. As a strategic cooperation partner for day-to-day routine activities in and outside the laboratory, we support you in overcoming your current and future challenges.

We offer significant added value by supporting the efficien-

cy of your workflows. For example, our digital solutions create a connection between pre-bar-coded test tubes and patient data from the laboratory information system. This reliably rules out mix-ups and minimizes sampling errors. Your workflows can thus be measurably optimized, better results can be achieved with minimum time, resources, and work.



YOUR STRATEGIC PARTNER:

- / Increased efficiency
- / Digital solutions
- / Best practice recommendations



DISCOVER MORE:



We are committed to climate protection and limiting global warming to 1.5°C.



SUSTAINABILITY

the principle behind
our processes for
many years

BECAUSE IT'S REALLY IMPORTANT TO US

Sustainable action is the basic prerequisite for a future worth living in. As a plastics processing company, we strive to develop sustainable solutions that provide answers to the major challenges of our time.

Greiner AG's overarching "Blue-Plan" strategy focuses on the three pillars of climate, circular economy and people. Greiner

Bio-One is also working intensively on these sub-areas.

As a producer of plastic medical products, it is our declared long-term goal to combine ecological, economic and social aspects. We attach particular importance not only to your excellent supply of high-quality products, but also to energy-efficient and sustainable operation as a plastics producer.



OUR GOALS UNTIL 2030:

- / **Comprehensive circular approach**
- / **Preparation of employees for the challenges of the future**

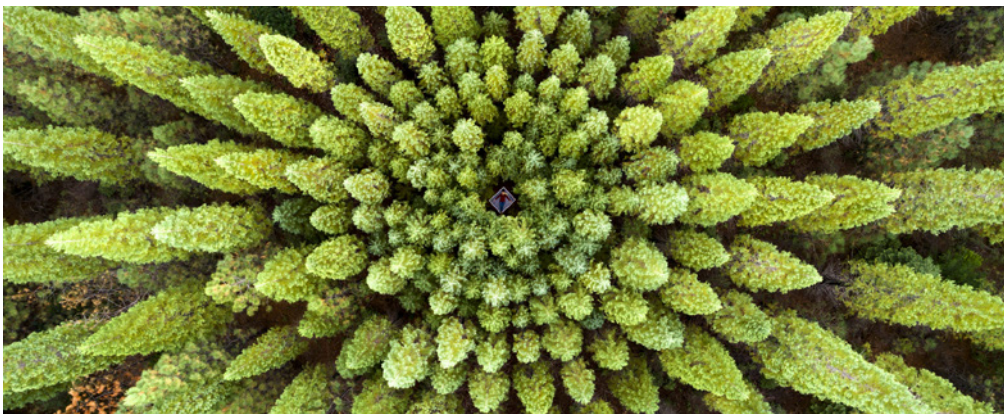

DISCOVER
MORE:

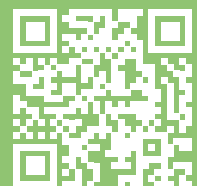

35

CELL CULTURE

CELLSTAR® Cell Culture Flasks	36
CELLSTAR® Cell Culture Dishes	46
CELLSTAR® Cell Culture Multiwell Plates	51
ThinCert® Cell Culture Inserts for 6, 12 and 24 Well Multiwell Plates	54
ThinCert® 96 Well HTS Insert For high-throughput applications	58
CELLSTAR® Cell Culture Microplates	60
CELLSTAR® Cell Culture Tubes	68
EASYstrainer Cell Strainers	70

73

MASS CELL CULTURE

CELLMASTER Cell Culture Roller Bottles	74
CELLdisc Cell Culture Device	77

85

3D CELL CULTURE

CELLSTAR® Cell Culture Vessels Cell-Repellent Surface	86
Magnetic 3D Cell Culture	90
ThinCert® Cell Culture Inserts for 6, 12 and 24 Well Multiwell Plates	95

101

PRODUCTS FOR MICROSCOPY

CELLview Dish Cell Culture Dish with Glass Bottom	102
CELLview Slide Cell Culture Slide with Glass Bottom	104
CELLview Plate Cell Culture Plate with Glass Bottom	106
SCREENSTAR Microplates	108
SensoPlate Glass Bottom Microplates	110



shop.gbo.com

Online Shop

113

HTS-MICROPLATES

96 Well Microplates	114
384 Well Microplates	118
1536 Well Microplates	122
Polypropylene Storage Plates	124
Microplates for Compound Storage	128
Non-binding Microplates	130
Streptavidin-coated Microplates	133
UV-Star® Microplates	135
Lids / Sealers / CapMats	137
Protein Crystallisation Plates	140

143

IMMUNOLOGY / HLA

ELISA Microplates	144
ELISA Strip Plates	146
Immuno Tubes	149
Terasaki Plates	151

155

MICROBIOLOGY

Dishes / Plates / Others	156
--------------------------	-----

163

TUBES / MULTIPURPOSE BEAKERS

Tubes without closures	164
Tubes with closures	167
Separation Tubes	173
Multipurpose Containers / Beakers	175

PRODUCTS

183 CRYOTECHNICS

Cryo.s Cryo Tubes	184
Cryo.s with Barcode	191
Cryo.s Biobanking Tubes sterile	194

207 REACTION TUBES / ANALYSER CUPS

Reaction Tubes Analyser Cups	208
Semi-micro / Macro Cuvette	211

215 MOLECULAR BIOLOGY

Sapphire PCR Tubes	216
Sapphire PCR Microplates	222

227 LIQUID HANDLING

Sapphire Pipettes	228
Sapphire Pipette Tips	232
CELLSTAR® Serological Pipettes	241

247 LAB EQUIPMENT

Lab Equipment	248
---------------	-----

253 TECHNICAL APPENDIX



WE ARE PROUD TO PRESENT YOU OUR NEW DIGITAL SHOWROOM & 3D CELL CULTURE LAB





The secret of the continuing success of the CELLSTAR® product line from Greiner Bio-One lies in its high quality and reliability. For more than 60 years, Greiner Bio-One has been setting standards for future-oriented research and new technologies in the field of cell culture.



/ This video shows how much fun you can have with our cell culture flasks in your lab:



CELLSTAR® CELL CULTURE FLASKS

Greiner Bio-One offers standard and filter cap cell culture flasks with different surfaces. All Greiner Bio-One cell culture flasks are made of high-grade polystyrene and are free of detectable DNases, RNases, human DNA, endotoxins and are non-cytotoxic.

The specific design facilitates optimal access to the flask when using a cell scraper or pipette. The top stacking rim stabilizes the flask and facilitates easy flask stacking in the incubator.

Both sides of the flask have printed graduation marks to aid liquid fill. Filter or standard screw caps options available with click-in ventilation positioning to guarantee gas exchange.

Greiner Bio-One flasks offer a specific physical surface treatment to ensure adhesion and proliferation of adherent cells. In contrast, the Advanced TC surface options provide optimal conditions for the cultivation of sensitive and fastidious cells as well as for use in restricted growth conditions.

- / Standard or filter screw cap
- / Canted neck
- / Sterile and user-friendly packaging
- / Growth area for adherent cells: 25, 75 and 175 cm²
- / Filling volume for suspension cells: 50, 250, 550, 650 ml



CELLSTAR® Standard Cell Culture Flasks

For the maintenance of adherent cells Greiner Bio-One offers a specific physical surface treatment which ensures adhesion and proliferation of these cells.

/ Item No. 690170 with measuring grid

STERILE

FREE OF
detectable
DNase

FREE OF
detectable
human DNA

FREE OF
detectable
RNase

non-
cytotoxic

non-
pyrogenic

Raw material: PS, Surface treatment: TC, Sterile: +

Item no.	Flask design	Growth area	Cap colour	Working volume	Total volume	Cap design	Tri-ple-packed	Sterile	Qty. inner / outer
690160		25 cm ²	● red	5 ml - 10 ml	50 ml	screw cap		+	10 / 200
690170		25 cm ²	● red	5 ml - 10 ml	50 ml	screw cap		+	10 / 200
690160-TRI		25 cm ²	● red	5 ml - 10 ml	50 ml	screw cap	yes	+	10 / 130
690175		25 cm ²	● red	5 ml - 10 ml	50 ml	filter screw cap		+	10 / 200
690175-TRI		25 cm ²	● red	5 ml - 10 ml	50 ml	filter screw cap	yes	+	10 / 130
658170		75 cm ²	● red	15 ml - 38 ml	250 ml	screw cap		+	5 / 120
658170-TRI		75 cm ²	● red	15 ml - 38 ml	250 ml	screw cap	yes	+	5 / 90
658175		75 cm ²	● red	15 ml - 38 ml	250 ml	filter screw cap		+	5 / 120
658175-TRI		75 cm ²	● red	15 ml - 38 ml	250 ml	filter screw cap	yes	+	5 / 90
660160	flat	175 cm ²	● red	20 ml - 45 ml	550 ml	screw cap		+	5 / 50
660160-TRI	flat	175 cm ²	● red	20 ml - 45 ml	550 ml	screw cap	yes	+	5 / 40
660175	flat	175 cm ²	● red	20 ml - 45 ml	550 ml	filter screw cap		+	5 / 50
660175-TRI	flat	175 cm ²	● red	20 ml - 45 ml	550 ml	filter screw cap	yes	+	5 / 40
661160	high	175 cm ²	● red	20 ml - 85 ml	650 ml	screw cap		+	4 / 40
661175	high	175 cm ²	● red	20 ml - 85 ml	650 ml	filter screw cap		+	4 / 40

/ The item no. of triple-packed products is composed of the standard item no. plus -TRI (e.g. 604160-TRI). In general, all Greiner Bio-One cell culture products can be produced triple-packed. Please contact your Greiner Bio-One sales representative regarding customised triple-packed products.



Replacement Filter Flask Caps

A specific capillary pore membrane is used for the filter screwcaps of our filter cap cell culture flasks. The defined pore diameter of 0.2 µm provides a sterile barrier against contamination. The inner surface of the PET membrane is PTFE-coated generating a hydrophobic facing which prevents wetting of the filter material from internal liquid. Due to the high airflow rate of the filter material, an optimal gas exchange is ensured.



Sterile: +

Item no.	Sterile	Qty. inner / outer
315361	+	- / 1,000
350382	+	- / 720
358361	+	3 / 600

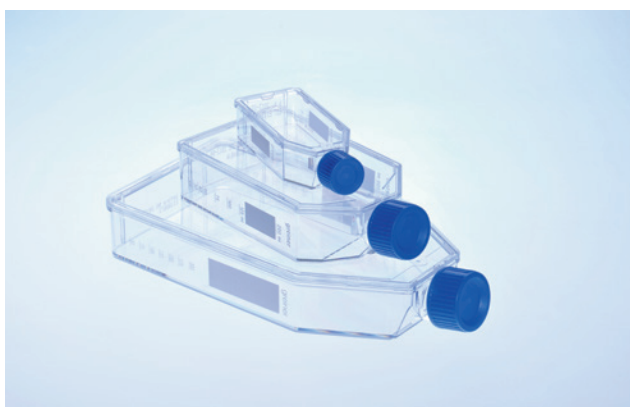

Cell Culture Flasks - Advanced TC

The Advanced TC surface provides optimal conditions for the cultivation of sensitive and fastidious cells or the usage of restricted growth conditions.

- / Consistent and even cell attachment
- / Homogeneous and optimised cell growth



Raw material: PS, Surface treatment: Advanced TC, Sterile: +

Item no.	Flask design	Growth area	Cap colour	Working volume	Total volume	Cap design	Sterile	Qty. inner / outer
690975		25 cm ²	● blue	5 ml - 10 ml	50 ml	filter screw cap	+	10 / 200
658970		75 cm ²	● blue	15 ml - 38 ml	250 ml	screw cap	+	5 / 120
658975		75 cm ²	● blue	15 ml - 38 ml	250 ml	filter screw cap	+	5 / 120
660960	flat	175 cm ²	● blue	20 ml - 45 ml	550 ml	screw cap	+	5 / 50
660975	flat	175 cm ²	● blue	20 ml - 45 ml	550 ml	filter screw cap	+	5 / 50
661960	high	175 cm ²	● blue	20 µl - 85 µl	650 ml	screw cap	+	4 / 40

Item no.	Flask design	Growth area	Cap colour	Working volume	Total volume	Cap design	Sterile	Qty. inner / outer
661975	high	175 cm ²	● blue		650 ml	filter screw cap	+	4 / 40

/ Forum No. 12: Advanced TC: An innovative surface improving cellular assays (F071104)

/ Application Report „Advanced TC for improving the cultivation / differentiation of embryonic stem cells“ (F076036)



Cell Culture Flasks - CELLCOAT®

- / Canted neck for optimal access
- / Graduation on both sides
- / Improved adhesion and cell proliferation
- / Reduced-serum or serum-free cultivation
- / Improved growth of primary cells

Raw material: PS, Surface treatment: CELLCOAT®, Cap design: filter screw cap

Item no.	Flask design	Growth area	Protein coating	Cap colour	Working volume	Total volume	Qty. inner / outer
690950		25 cm ²	Collagen Type I	● red	5 ml - 10 ml	50 ml	10 / 50
658950		75 cm ²	Collagen Type I	● red	15 ml - 38 ml	250 ml	5 / 50
661950	high	175 cm ²	Collagen Type I	● red	20 ml - 85 ml	650 ml	5 / 40
690940		25 cm ²	Poly-D-Lysine	● red	5 ml - 10 ml	50 ml	10 / 50
658940		75 cm ²	Poly-D-Lysine	● red	15 ml - 38 ml	250 ml	5 / 50
658930		75 cm ²	Poly-L-Lysine	● red	15 ml - 38 ml	250 ml	5 / 50
661940	high	175 cm ²	Poly-D-Lysine	● red	20 ml - 85 ml	650 ml	5 / 40
690920		25 cm ²	Fibronectin	● red	5 ml - 10 ml	50 ml	10 / 10
658920		75 cm ²	Fibronectin	● red	15 ml - 38 ml	250 ml	10 / 10
661920	high	175 cm ²	Fibronectin	● red	20 ml - 85 ml	650 ml	5 / 5
690910		25 cm ²	Laminin	● red	5 ml - 10 ml	50 ml	5 / 10
658910		75 cm ²	Laminin	● red	15 ml - 38 ml	250 ml	5 / 10
661910	high	175 cm ²	Laminin	● red	20 ml - 85 ml	650 ml	5 / 5



Suspension Culture Flasks

- / Hydrophobic surface, ideal for suspension cultures, hybridoma and embryonic stem cells
- / Graduation on both sides
- / Sterile and user-friendly packaging
- / Canted neck for optimal access

STERILE	FREE OF detectable DNase	FREE OF detectable human DNA	FREE OF detectable RNase	non-cytotoxic	non-pyrogenic
---------	--------------------------	------------------------------	--------------------------	---------------	---------------

Raw material: PS, Surface treatment: suspension, Sterile: +

Item no.	Flask design	Cap colour	Total volume	Cap design	Triple-packed	Sterile	Qty. inner / outer
690190		○ white	50 ml	screw cap		+	10 / 200
690190-TRI		○ white	50 ml	screw cap	yes	+	10 / 130
690195		○ white	50 ml	filter screw cap		+	10 / 200
690195-TRI		○ white	50 ml	filter screw cap	yes	+	10 / 130
658190		○ white	250 ml	screw cap		+	5 / 120
658190-TRI		○ white	250 ml	screw cap	yes	+	5 / 90
658195		○ white	250 ml	filter screw cap		+	5 / 120
658195-TRI		○ white	250 ml	filter screw cap	yes	+	5 / 90
660190	flat	○ white	550 ml	screw cap		+	5 / 50
660190-TRI	flat	○ white	550 ml	screw cap	yes	+	5 / 40
661190	high	○ white	650 ml	screw cap		+	4 / 40
661195	high	○ white	650 ml	filter screw cap		+	4 / 40
661195-TRI	high	○ white	650 ml	filter screw cap	yes	+	4 / 28

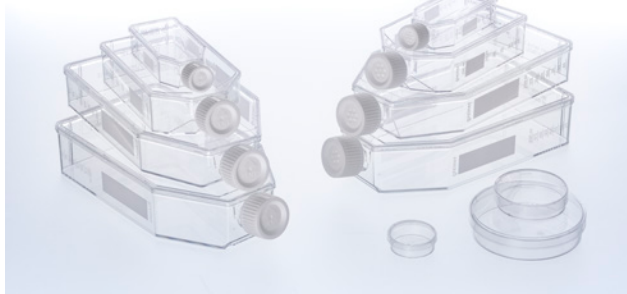
Cell Culture Flasks**Cell-Repellent Surface**

A cell-repellent surface reliably prevent cell attachment in suspension cultures of semi-adherent and adherent cell lines where standard hydrophobic surfaces generally used for suspension culture are insufficient.

STERILE

FREE OF
detectable
DNaseFREE OF
detectable
human DNAFREE OF
detectable
RNase
 non-
cytotoxic

 non-
pyrogenic

Raw material: PS, Surface treatment: cell-repellent, Sterile: +

Item no.	Flask design	Cap colour	Total volume	Cap design	Sterile	Qty. inner / outer
690980	flat	○ white	50 ml	screw cap	+	10 / 20
690985	flat	○ white	50 ml	filter screw cap	+	10 / 20
658980	flat	○ white	250 ml	screw cap	+	5 / 15
658985	flat	○ white	250 ml	filter screw cap	+	5 / 15
660980	flat	○ white	550 ml	screw cap	+	5 / 5
660985	flat	○ white	550 ml	filter screw cap	+	5 / 5
661980	high	○ white	650 ml	screw cap	+	4 / 4
661985	high	○ white	650 ml	filter screw cap	+	4 / 4

**AutoFlask - Cell Culture Flask
For Automated Systems**

- / Standard microplate footprint
- / Compatible with a wide range of cell culture and liquid handling systems
- / Hydrophobic filter membrane
- / Different surface treatments
- / Customised barcoding on request

STERILE

FREE OF
detectable
DNaseFREE OF
detectable
human DNAFREE OF
detectable
RNase
 non-
cytotoxic

 non-
pyrogenic

Flask design: AutoFlask, Growth area: 83.6 cm², Raw material: PS, Total volume: 110 ml, Sterile: +

Item no.	Barcode	Surface treatment	Product colour	Colour code	Working volume	Sterile	Qty. inner / outer
779160	yes	TC	○ clear	● red	20 ml - 40 ml	+	10 / 100

Item no.	Barcode	Surface treatment	Product colour	Colour code	Working volume	Sterile	Qty. inner / outer
779190	yes	suspension	○ clear	○ white	60 ml - 80 ml	+	10 / 100

/ Further information on the AutoFlask: "Comparative cell growth study using the AutoFlask"(F072094)



Cell Scraper

- / For gentle mechanical removal of adherent cells
- / Optimised blade design for maximum cell harvest
- / Blade length: 1.8 cm
- / Pivot angle 60°
- / Sterile individual packaging

STERILE

Description: Cell Scraper, Feature: blade length 1.8 cm, Sterile: +

Item no.	Length	Sterile	Qty. inner / outer
541070	28 cm	+	50 / 100
541080	40 cm	+	100 / 100



Media Bottles

- / Made of polyethylene terephthalate (PET)
- / Available in three sizes
- / With graduation
- / Triple-packed for GMP compliant workflow

STERILE

FREE OF detectable DNase

FREE OF detectable human DNA

FREE OF detectable RNase

non-cytotoxic

non-pyrogenic

Flask design: Tetragonal, Raw material: PET, Cap design: screw cap, Sterile: +

Item no.	Cap colour	Total volume	Sterile	Qty. inner / outer
950700	○ white	500 ml	+	25 / 50
951700	○ white	100 ml	+	25 / 100
952700	○ white	1,000 ml	+	24 / 24



Disposal Bags

Disposal bags made of polypropylene for sterilisation in the steam autoclave. For users of hot-air sterilisers, disposal bags made of polyamide are suitable for use up to +160 °C.

Item no.	Feature	Length	Width	Foil thickness	Nominal capacity	Suitable for steam autoclaves	Suitable for hot air sterilizers	Volume	Material	Qty. inner / outer
BAG1										- / 200
BAG2								30 l		- / 200
BAG3								65 l		- / 200
643201		500 mm	300 mm	0.05 mm	10 l	yes			PP	500 / 500
643203	Imprint "Biohazard"	500 mm	300 mm	0.05 mm	10 l	yes			PP	500 / 500
643401		500 mm	300 mm	0.05 mm	10 l		yes		PA	500 / 500
644201		780 mm	400 mm	0.05 mm	30 l	yes			PP	500 / 500
644203	Imprint "Biohazard"	780 mm	400 mm	0.05 mm	30 l	yes			PP	500 / 500
644401		780 mm	400 mm	0.05 mm	30 l		yes		PA	500 / 500
646201	Imprint "Biohazard"	780 mm	600 mm	0.05 mm	65 l	yes			PP	500 / 500
646203		780 mm	600 mm	0.05 mm	65 l	yes			PP	1 / 500
646401		780 mm	600 mm	0.05 mm	65 l		yes		PA	300 / 300
649201		1,100 mm	700 mm	0.05 mm	130 l	yes			PP	350 / 350
649203	Imprint "Biohazard"	1,100 mm	700 mm	0.05 mm	130 l	yes			PP	350 / 350
649401		1,100 mm	700 mm	0.05 mm	130 l		yes		PA	200 / 200

Disposal Bags

- / Ideal for the hygienic disposal of contaminated laboratory items
- / Disposal bags are made of polypropylene foil for sterilisation of items in a steam autoclave.
- / For users of hot-air sterilisers, disposal bags are made of polyamide and are usable up to a temperature of +160 °C.
- / Foil thickness 0.05mm
- / Suitable for steam autoclaves
- / Pre-printed with Biohazard symbol

Item no.	Volume	Qty. inner / outer
BAG2	30 l	- /200
BAG3	65 l	- /200



Faeces / Urine Containers

- / Available in different sizes
- / Range of caps and spoons
- / Easy and safe handling
- / CE-marked
- / Bottom part of containers manufactured from crystal clear polystyrene

Item no.	Cap colour	Qty. inner / outer
201180	● red	- /400
443103	● blue	- /400



Hypodermic Syringes / Needles

- / For clinical and research use
- / Individually packed and sterile
- / 2 ml, 5 ml, 10 ml and 20 ml Luer Lock versions available (to order add LL suffix to Cat.-No.) case sizes are consistent with Luer Slip versions

Item no.	Description	Feature	Volume	Sterile	Qty. inner / outer
N1938	19 g x 1 1/4" needle				- /100
N2316	23 g x 5/8" needle				- /100
N2325	23 g x 1" needle				- /100
N2525	25 g x 1"				- /100
N2516	25 g x 5/8" needle				- /100
N2332	23 g x 1 1/4" needle				- /100
SYR30	Luer slip syringe	Eccentric	30 ml	+	- /25
SYR20	Luer slip syringe	Eccentric	20 ml	+	- /50
SYR1	Luer slip syringe	Concentric	1 ml	+	- /100
SYR2-5	Luer slip syringe	Concentric	2.5 ml	+	- /100
SYR5	Luer slip syringe	Concentric	5 ml	+	- /100
SYR50LS	Luer slip syringe	Eccentric	50 ml	+	- /25
SYR50	Luer lock syringe	Concentric	50 ml	+	- /25
SYR10	Luer slip syringe	Concentric	10 ml	+	- /100
N2138	21 g x 1 1/2" needle				- /100
N1950	19 g x 2" needle				- /100

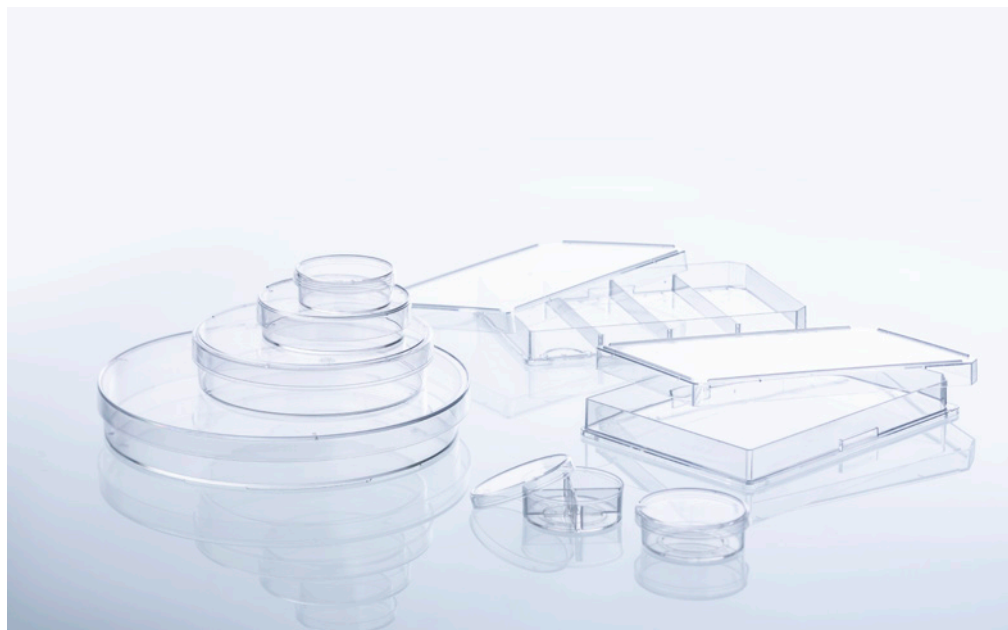

/ For exact dimensions of our cell culture dishes, please refer to the product data sheets on our website.



CELLSTAR® CELL CULTURE DISHES

Our CELLSTAR® cell culture dishes are manufactured to meet the highest quality standards at Greiner Bio-One.

This assortment of dishes offers a range of growth sizes from 8.7 to 143 cm². These dimensions are provided in nominal sizes of 35, 60, 100, and 145 mm. For culture dishes associated with growth areas of either 58 or 143 cm², we supply variants with side heights of 20 mm (for special applications). In addition to our standard formats we offer 35 mm cell culture dishes that are equipped with four in-

ner rings. Our standard cell culture dishes have been treated in order to optimise growth and adhesion.

However, we are also capable of providing sterile cell culture trays without any type of coating for suspension culture. Similar to all of our cell culture laboratory products, this range of dishes is packed user-friendly within sterile conditions. This allows technicians to safely handle their samples with a wide variety of cell culture methods without the risk of cell culture contamination.

- / Easy stacking
- / Maximal transparency for excellent microscopic analysis
- / Improved cell adhesion through physical surface treatment

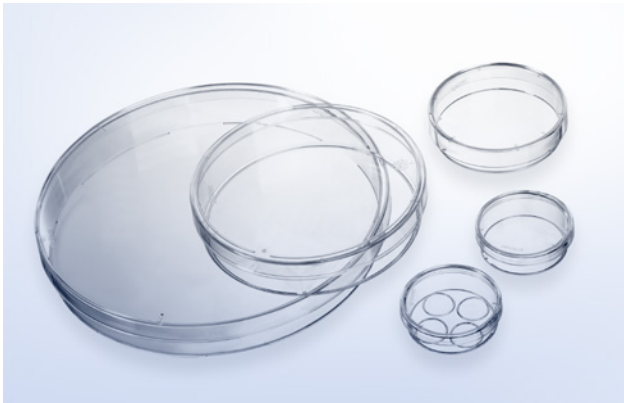

Cell Culture Dishes

- / Improved cell adhesion through physical surface treatment
- / Maximal transparency for excellent microscopic analysis
- / Sterile and user-friendly packaging
- / Easy stacking



Surface treatment: TC, Vent nock: yes, Sterile: +

Item no.	Compartment	Height	Ø nominal size	Growth area	Growth area / unit	Working volume	Total volume	Triple-packed	Sterile	Qty. inner / outer
627160		10 mm	35 mm	8.7 cm ²		≥3 ml	10 ml		+	10 / 740
627170	4	10 mm	35 mm		0.93 cm ²	≥0.08 ml	9 ml		+	10 / 740
628160		15 mm	60 mm	21 cm ²		6 ml - 7 ml	28 ml		+	10 / 600
628160-TRI		15 mm	60 mm	21 cm ²		6 ml - 7 ml	28 ml	yes	+	10 / 300
664160		20 mm	100 mm	58 cm ²		16 ml - 17 ml	100 ml		+	15 / 360
664160-TRI		20 mm	100 mm	58 cm ²		16 ml - 17 ml	100 ml	yes	+	15 / 180
639160		20 mm	145 mm	143 cm ²		25 ml - 27 ml	240 ml		+	5 / 120
639160-TRI		20 mm	145 mm	143 cm ²		25 ml - 27 ml	240 ml	yes	+	5 / 120

/ For exact dimensions of our cell culture dishes, please refer to the product data sheets on our website.



Cell Culture Dishes - Advanced TC

The Advanced TC surface provides optimal conditions for the cultivation of sensitive and fastidious cells or the usage of restricted growth conditions.

- / Consistent and even cell attachment
- / Homogeneous and optimised cell growth



Surface treatment: Advanced TC, Vent nock: yes, Sterile: +

Item no.	Height	Ø nominal size	Growth area	Working volume	Total volume	Sterile	Qty. inner / outer
627960	10 mm	35 mm	8.7 cm ²	≤3 ml	10 ml	+	10 / 740
628960	15 mm	60 mm	21 cm ²	6 ml - 7 ml	28 ml	+	10 / 600

Item no.	Height	Ø nominal size	Growth area	Working volume	Total volume	Sterile	Qty. inner / outer
664960	20 mm	100 mm	58 cm ²	16 ml - 17 ml	100 ml	+	15 / 360
639960	20 mm	145 mm	143 cm ²	25 ml - 27 ml	240 ml	+	5 / 120

/ Forum No. 12: Advanced TC: An innovative surface improving cellular assays (F071104)

/ Application Report „Advanced TC for improving the cultivation / differentiation of embryonic stem cells“ (F076036)

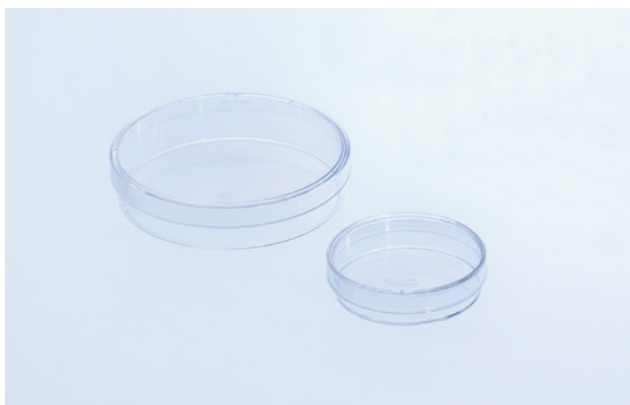

Cell Culture Dishes - CELLCOAT®

- / Improved adhesion and cell proliferation
- / Reduced-serum or serum-free cultivation
- / Improved growth of primary cells

Surface treatment: CELLCOAT®, Vent neck: yes

Item no.	Height	Ø nominal size	Growth area	Protein coating	Working volume	Total volume	Qty. inner / outer
628950	15 mm	60 mm	21 cm ²	Collagen Type I	6 ml - 7 ml	28 ml	20 / 100
664950	20 mm	100 mm	58 cm ²	Collagen Type I	16 ml - 17 ml	100 ml	10 / 40
628940	15 mm	60 mm	21 cm ²	Poly-D-Lysine	6 ml - 7 ml	28 ml	20 / 100
664940	20 mm	100 mm	58 cm ²	Poly-D-Lysine	16 ml - 17 ml	100 ml	10 / 40
628930	15 mm	60 mm	21 cm ²	Poly-L-Lysine	6 ml - 7 ml	28 ml	20 / 100
628920	15 mm	60 mm	21 cm ²	Fibronectin	6 ml - 7 ml	28 ml	5 / 20
664920	20 mm	100 mm	58 cm ²	Fibronectin	16 ml - 17 ml	100 ml	5 / 10
628910	15 mm	60 mm	21 cm ²	Laminin	6 ml - 7 ml	28 ml	5 / 20
664910	20 mm	100 mm	58 cm ²	Laminin	16 ml - 17 ml	100 ml	10 / 10

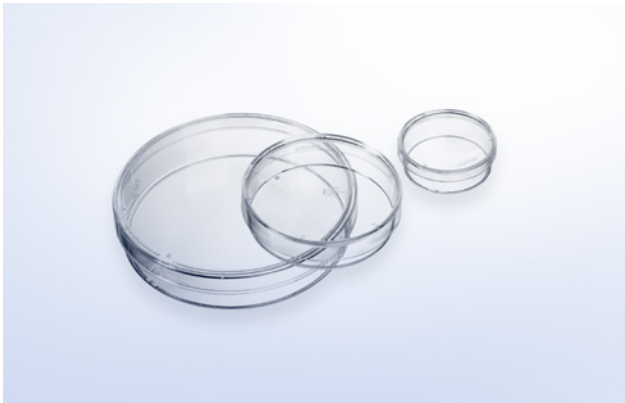

Cell Culture Dishes Cell-Repellent Surface

Cell culture vessels with cell-repellent surface reliably prevent cell attachment in suspension cultures of semi adherent / adherent cell lines where standard hydrophobic surfaces generally used for suspension culture are insufficient.



Raw material: PS, Surface treatment: cell-repellent, Vent neck: yes, Sterile: +

Item no.	Height	Ø nominal size	Working volume	Total volume	Sterile	Qty. inner / outer
627979	10 mm	35 mm	≤3 ml	10 ml	+	10 / 40
628979	15 mm	60 mm	6 ml - 7 ml	28 ml	+	10 / 20
664970	20 mm	100 mm	16 ml - 17 ml	100 ml	+	1 / 5

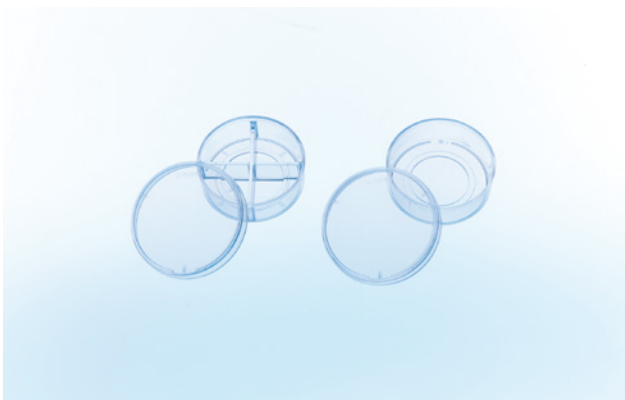

CELLview Dish

The CELLview cell culture dish combines the convenience of a standard size 35 mm disposable plastic cell culture dish with the optical quality of glass, providing superior high-resolution microscopic images of *in-vitro* cultivated cultures.

/ Embedded glass bottom for maximal planarity



Ø: 35 mm, Bottom: glass, Vent neck: yes, Sterile: +

Item no.	Compartments	Growth area	Growth area / unit	Surface treatment	Working volume	Total volume	Total volume (well)	Working volume (well)	Sterile	Qty. inner / outer
627861	1	8.7 cm ²		untreated	2.5 ml - 5 ml	10 ml			+	10 / 40
627860	1	8.7 cm ²		TC	2.5 ml - 5 ml	10 ml			+	10 / 40
627965	1	8.7 cm ²		Advanced TC	2.5 ml - 5 ml	10 ml			+	10 / 40
627871	4		1.9 cm ²	untreated			1.5 ml	0.1 ml - 0.5 ml	+	10 / 40

Item no.	Compartments	Growth area	Growth area / unit	Surface treatment	Working volume	Total volume	Total volume (well)	Working volume (well)	Sterile	Qty. inner / outer
627870	4		1.9 cm ²	TC			1.5 ml	0.1 ml - 0.5 ml	+	10 / 40
627975	4		1.9 cm ²	Advanced TC			1.5 ml	0.1 ml - 0.5 ml	+	10 / 40

/ Application Note „Protein localisation using confocal laser scanning microscopy“(F073101)

/ Application Note „Live cell imaging on Golgi morpholgy using the CELLview dish“(F074048)

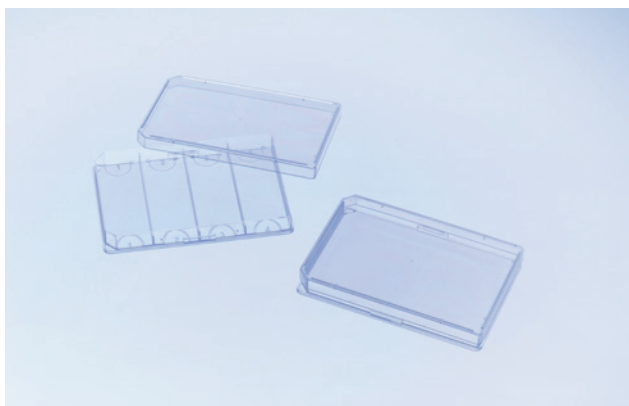

OneWell Plate

FourWell Plate

- / For the cultivation of a large number of cells the OneWell Plate with ANSI standard dimensions offers the best possible conditions.
- / The FourWell Plates allows users to culture cells on slides while remaining in accordance with an HTS-compatible plate. This four-chambered plate is particularly suitable for parallel experiments.

STERILE

FREE OF detectable DNase

FREE OF detectable human DNA

FREE OF detectable RNase

 non-cytotoxic

 non-pyrogenic

Height: 14.4 mm, Length: 127.8 mm, Width: 85.5 mm, Lid: yes, Vent nock: yes, Sterile: +

Item no.	Well format	Growth area	Surface treatment	Product colour	Total volume (well)	Sterile	Qty. inner / outer
96077307	4		suspension	○ clear	18.6 ml	+	8 / 32
670190	1	95 cm ²	suspension	○ clear	113.7 ml	+	8 / 32
670180	1	95 cm ²	TC	○ clear	113.7 ml	+	8 / 32

/ Sample packs are available on request.



/ Watch our video:



CELLSTAR® CELL CULTURE MULTIWELL PLATES

- / With hydrophilic surface (TC surface treatment) for improved cell adhesion
- / With hydrophobic surface for suspension cultures and hybridoma cells
- / High clarity and low autofluorescence
- / Alphanumeric well coding

For both adherent and suspension cell culture, choose Greiner Bio-One's multiwell plates in either 6, 12, 24 or 48 well format.

The special chimney wells in conjunction with low evaporation lids significantly reduce the risk of cross-contamination between the wells. The plates are easily stacked, both with and without lids. Due to their ad-

vanced design, the plates still exhibit important features like constant heat and gas exchange even when stacked. Uniform plate dimensions (well depth, diameter and distance between the wells) comply with ANSI standards, enabling easy manual and automated handling. Each plate is sterile, free of detectable DNase, RNase, human DNA, is non-pyrogenic and has a printed lot number for traceability.

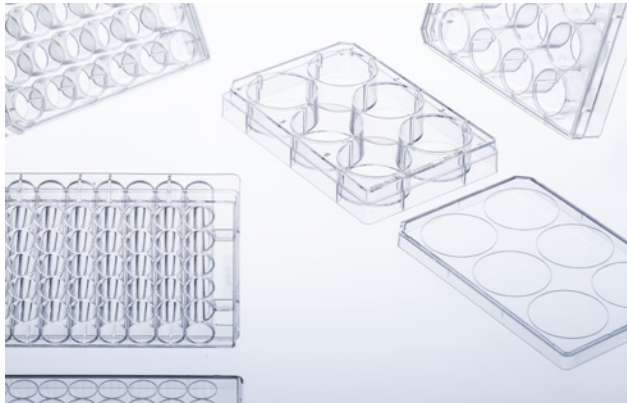

Multiwell Plates

6 / 12 / 24 / 48 Well Format

- / High transparency
- / Alphanumeric well coding
- / With hydrophilic surface (TC surface treatment) for improved cell adhesion
- / With hydrophobic surface for suspension cultures and hybridoma cells

STERILE	FREE OF detectable DNase	FREE OF detectable human DNA	FREE OF detectable RNase	non-cytotoxic	non-pyrogenic
---------	--------------------------	------------------------------	--------------------------	---------------	---------------

Bottom: solid, Raw material: PS, Lid: yes, condensation rings, Sterile: +

Item no.	Well format	Growth area / unit	Surface treatment	Product colour	Total volume (well)	Working volume (well)	Sterile	Qty. inner / outer
657160	6	9.6 cm ²	TC	○ clear	16 ml	2 ml - 5 ml	+	1 / 100
665180	12	3.9 cm ²	TC	○ clear	6.5 ml	2 ml - 4 ml	+	1 / 100
677180	48	1 cm ²	TC	○ clear	1.7 ml	0.5 ml - 1 ml	+	1 / 100
657185	6		suspension	○ clear	16 ml	2 ml - 5 ml	+	1 / 100
665102	12		suspension	○ clear	6.5 ml	2 ml - 4 ml	+	1 / 100
677102	48		suspension	○ clear	1.7 ml	0.5 ml - 1 ml	+	1 / 100
657165	6	9.6 cm ²	TC	○ clear	16 ml	2 ml - 5 ml	+	5 / 120
665165	12	3.9 cm ²	TC	○ clear	6.5 ml	2 ml - 4 ml	+	- / 120
677165	48	1 cm ²	TC	○ clear	1.7 ml	0.5 ml - 1 ml	+	5 / 120

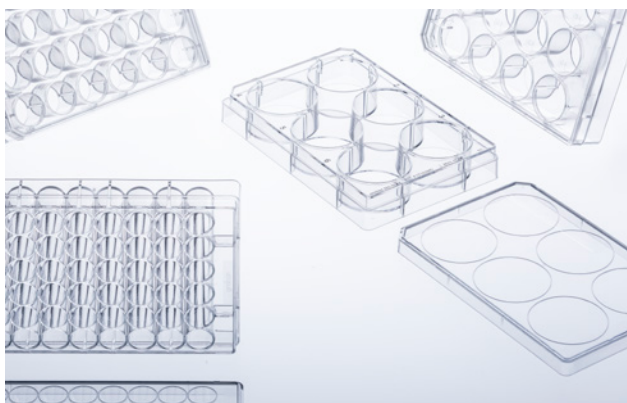

Multiwell Plates

Advanced TC

The Advanced TC surface provides optimal conditions for the cultivation of sensitive and fastidious cells or the usage of restricted growth conditions.

- / Consistent and even cell attachment

STERILE	FREE OF detectable DNase	FREE OF detectable human DNA	FREE OF detectable RNase	non-cytotoxic	non-pyrogenic
---------	--------------------------	------------------------------	--------------------------	---------------	---------------

Bottom: solid, Raw material: PS, Surface treatment: Advanced TC, Lid: yes, condensation rings, Sterile: +

Item no.	Well format	Growth area / unit	Product colour	Total volume (well)	Working volume (well)	Sterile	Qty. inner / outer
657960	6	9.6 cm ²	○ clear	16 ml	2 ml - 5 ml	+	1 / 100

Item no.	Well format	Growth area / unit	Product colour	Total volume (well)	Working volume (well)	Sterile	Qty. inner / outer
665980	12	3.9 cm ²	○ clear	6.5 ml	2 ml - 4 ml	+	1 / 100
677980	48	1 cm ²	○ clear	1.7 ml	0.5 ml - 1 ml	+	1 / 100

/ Forum No. 12: Advanced TC: An innovative surface improving cellular assays (F071104)

/ Application Report „Advanced TC for improving the cultivation / differentiation of embryonic stem cells“ (F076036)



Multiwell Plates CELLCOAT®

- / Improved adhesion and cell proliferation
- / Reduced-serum or serum-free cultivation
- / Improved growth of primary cells

Well format: 6, Growth area / unit: 9.6 cm², Bottom: solid, Raw material: PS, Surface treatment: CELLCOAT®, Total volume (well): 16.1 ml, Working volume (well): 2 ml - 5 ml, Lid: yes, condensation rings

Item no.	Protein coating	Product colour	Qty. inner / outer
657950	Collagen Type I	○ clear	5 / 50
657940	Poly-D-Lysine	○ clear	5 / 50
657930	Poly-L-Lysine	○ clear	5 / 50



Multiwell Plates Cell-Repellent Surface

Cell culture vessels with cell-repellent surface reliably prevent cell attachment in suspension cultures of semi adherent / adherent cell lines where standard hydrophobic surfaces generally used for suspension culture are insufficient.

STERILE

FREE OF
detectable
DNase

FREE OF
detectable
human DNA

FREE OF
detectable
RNase

non-
cytotoxic

non-
pyrogenic

Well profile: F-bottom, Bottom: solid, Raw material: PS, Surface treatment: cell-repellent, Lid: yes, condensation rings, Sterile: +

Item no.	Well format	Product colour	Total volume (well)	Working volume (well)	Sterile	Qty. inner / outer
657970	6	○ clear	16.1 ml	2 ml - 5 ml	+	1 / 5
677970	48	○ clear	1.7 ml	0.5 ml - 1 ml	+	1 / 5

/ Forum No. 17: CELLSTAR® Cell Culture Vessels with Cell-Repellent Surface (F073777)

/ Application Report "Advantage of CELLSTAR® Cell Culture Vessels with Cell-Repellent Surfaces for 3-D Cell Culture in Hydrogels" (F073792).



- / Forum No. 8: ThinCert® cell culture products – Overview (F073017)
- / Application Note „Immuno cytochemistry“(F073100)
- / For further information and application notes please refer to our website: www.gbo.com



THINCERT® CELL CULTURE INSERTS FOR 6, 12 AND 24 WELL MULTIWELL PLATES

For advanced cell and tissue culture applications, Greiner Bio-One offers a broad range of membrane supports - ThinCert®.

Combining 6 different membrane specifications (pore size and density) in geometries to fit 6, 12 and 24 well plates, the ThinCert® cell culture inserts are suitable for a wide range of applications including transport, secretion and diffusion studies, migrational experiments, cytotoxicity testing, co-cultures, trans epithelial electric resist-

ance (TEER) measurements, as well as primary cell culture.

ThinCert® cell culture inserts are compatible with standard CELLSTAR® multiwell plates from Greiner Bio-One, and are pre-packed together with the requisite number of plates. The automated production process includes double optical control of each insert produced, ensuring that any biological contamination is avoided. The sterility of the single blisterpacked inserts and multiwell plates is ensured by irradiation.

- / Stable clear polystyrene housing
- / Sealed PET capillary pore membrane
- / Pre-configured multiwell plates with ThinCert® cell culture inserts available on request



ThinCert® Cell Culture Inserts

6 Well

- / Hanging geometry
- / Improved cell adhesion through physical surface treatment
- / Simplified pipetting due to self-lift geometry
- / Enhanced pipetting access and gas exchange

STERILE

FREE OF
detectable
DNase

FREE OF
detectable
human DNA

FREE OF
detectable
RNase

 non-
cytotoxic

 non-
pyrogenic

Feature: 4 multiwell plates / box, Height: 16.25 mm, Ø internal: 24.85 mm, Ø external: 27.85 mm, Cultural surface: 452.4 mm², Surface treatment: TC, Working volume (ThinCert®): 1 ml - 3.6 ml, Working volume (well): 2 ml - 4.15 ml, Sterile: +

Item no.	Pore density	Ø pore	Optical membrane properties	Sterile	Qty. inner / outer
657640	1 x 10 ⁸ / cm ²	0.4 µm	translucent	+	1 / 24
657641	2 x 10 ⁸ / cm ²	0.4 µm	clear	+	1 / 24
657610	2 x 10 ⁸ / cm ²	1 µm	clear	+	1 / 24
657630	0,6 x 10 ⁶ / cm ²	3 µm	clear	+	1 / 24
657631	2 x 10 ⁸ / cm ²	3 µm	translucent	+	1 / 24
657638	0,15 x 10 ⁶ / cm ²	8 µm	translucent	+	1 / 24



ThinCert® Cell Culture Inserts

12 Well

- / Hanging geometry
- / Improved cell adhesion through physical surface treatment
- / Simplified pipetting due to self-lift geometry
- / Enhanced pipetting access and gas exchange

STERILE

FREE OF
detectable
DNase

FREE OF
detectable
human DNA

FREE OF
detectable
RNase

 non-
cytotoxic

 non-
pyrogenic

Feature: 4 multiwell plates / box, Height: 16.25 mm, Ø internal: 13.85 mm, Ø external: 15.85 mm, Cultural surface: 113.1 mm², Surface treatment: TC, Working volume (ThinCert®): 0.3 ml – 1 ml, Working volume (well): 1 ml – 2 ml, Sterile: +

Item no.	Pore density	Ø pore	Optical membrane properties	Sterile	Qty. inner / outer
665640	1 x 10 ⁸ / cm ²	0.4 µm	translucent	+	1 / 48
665641	2 x 10 ⁸ / cm ²	0.4 µm	clear	+	1 / 48
665610	2 x 10 ⁸ / cm ²	1 µm	clear	+	1 / 48
665630	0,6 x 10 ⁶ / cm ²	3 µm	clear	+	1 / 48
665631	2 x 10 ⁸ / cm ²	3 µm	translucent	+	1 / 48
665638	0,15 x 10 ⁶ / cm ²	8 µm	translucent	+	1 / 48

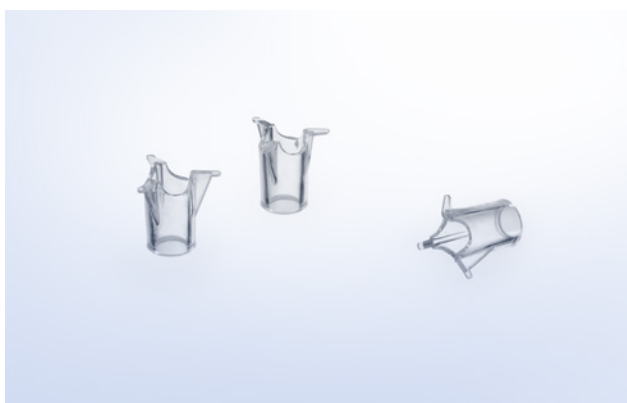
**ThinCert® Cell Culture Inserts****24 Well**

- / Hanging geometry
- / Improved cell adhesion through physical surface treatment
- / Simplified pipetting due to self-lift geometry
- / Enhanced pipetting access and gas exchange

STERILE

FREE OF
detectable
DNaseFREE OF
detectable
human DNAFREE OF
detectable
RNase
 non-
cytotoxic

 non-
pyrogenic

Feature: 2 multiwell plates / box, Height: 16.25 mm, Ø internal: 8.4 mm, Ø external: 10.4 mm, Cultural surface: 33.6 mm², Surface treatment: TC, Working volume (ThinCert®): 0.1 ml - 0.35 ml, Working volume (well): 0.4 ml - 1.2 ml, Sterile: +

Item no.	Pore density	Ø pore	Optical membrane properties	Sterile	Qty. inner / outer
662640	1 x 10 ⁸ / cm ²	0.4 µm	translucent	+	1 / 48
662641	2 x 10 ⁸ / cm ²	0.4 µm	clear	+	1 / 48
662610	2 x 10 ⁸ / cm ²	1 µm	clear	+	1 / 48
662630	0,6 x 10 ⁶ / cm ²	3 µm	clear	+	1 / 48
662631	2 x 10 ⁸ / cm ²	3 µm	translucent	+	1 / 48
662638	0,15 x 10 ⁶ / cm ²	8 µm	translucent	+	1 / 48

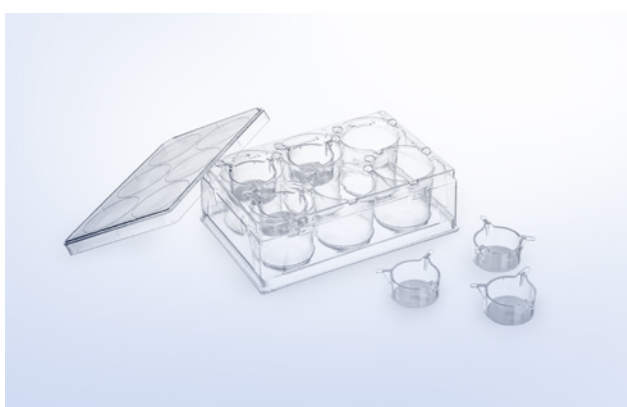
**ThinCert® Plate****6 / 12 Well**

- / Optimised for use with ThinCert® cell culture inserts
- / Deep wells for an increased volume of medium in air-lift culture
- / Notches for fixed insert position
- / Available in 6 and 12 well format

STERILE

FREE OF
detectable
DNaseFREE OF
detectable
human DNAFREE OF
detectable
RNase
 non-
cytotoxic

 non-
pyrogenic

Height: 39.5 mm, Length: 129.5 mm, Width: 86.6 mm, Lid: yes, condensation rings, Sterile: +

Item no.	Well format	Working volume (well)	Sterile	Qty. inner / outer
657110	6	≤20 ml	+	1 / 50
665110	12	≤4 ml	+	1 / 60



/ Application Note
"High-throughput
in-vitro airway mod-
elling with ThinCert®
96 Well HTS Insert"
(F073140)

THINCERT® 96 WELL HTS INSERT FOR HIGH-THROUGHPUT APPLICATIONS

ThinCert® 96 well HTS insert is the latest high-throughput addition to our ThinCert® family which opens doors to automation and offers an efficient solution to scale up your membrane-based cell culture application. Take advantage of the assay miniaturisation to maximise both time and cost savings when compared to single-insert solutions.

ThinCert® 96 well HTS inserts offer a diverse selection of membrane specifications (pore size and density) within a 96 well format. The automation-friendly inserts are highly versatile and can be utilised for various applications such as transport, secre-

tion, and diffusion studies, migration/invasion experiments, co-cultures, cytotoxicity tests, TEER measurements (Trans Epithelial Electric Resistance) and the generation of tissue models (e.g., endothelia and epithelia). The two-component system comprises a 96 well porous membrane plate manufactured entirely from polycarbonate (PC) and a corresponding polystyrene (PS) receiver plate. The tissue culture treated PC membrane allows for an ideal exchange of nutrients and substances, creating in vivo-like cultivation conditions to facilitate optimal cell growth, monolayer formation, and tissue differentiation.

- / 96 well system for high-throughput applications
- / Automation-friendly geometry
- / Pore sizes of 0.4 µm, 3 µm and 8 µm covering a range of different applications
- / High permeability and transparency for optimal diffusion rates and optical features

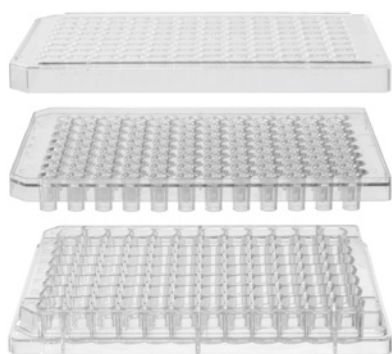

ThinCert® 96 Well HTS Insert (Membrane plates and receiver plates)

- / Pore sizes of 0.4 µm, 3 µm and 8 µm covering a range of different applications
- / High permeability and transparency for optimal diffusion rates and optical features
- / Working volume per well (membrane plate): 15 - 160 µl
- / Working volume per well (receiver plate): 120 - 300 µl

STERILE

FREE OF
detectable
DNaseFREE OF
detectable
human DNAFREE OF
detectable
RNase
 non-
cytotoxic

 non-
pyrogenic

Well format: 96, Surface treatment: TC, Lid: yes, condensation rings, Sterile: +

Item no.	Pore density	∅ pore	Optical membrane properties	Sterile	Qty. inner / outer
655640	1 x 10 ⁸ / cm ²	0.4 µm	translucent	+	1 / 5
655641	2 x 10 ⁷ / cm ²	0.4 µm	optimised transparency	+	1 / 5
655630	2 x 10 ⁶ / cm ²	3 µm	clear	+	1 / 5
655680	1 x 10 ⁵ / cm ²	8 µm	clear	+	1 / 5

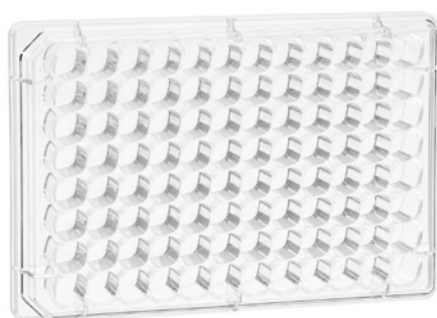

Receiver plates for ThinCert® 96 Well HTS Insert

- / Reduced wicking effect
- / High permeability and transparency for optimal diffusion rates and optical features
- / Working volume per well (receiver plate): 120 - 300 µl

STERILE

FREE OF
detectable
DNaseFREE OF
detectable
human DNAFREE OF
detectable
RNase
 non-
cytotoxic

 non-
pyrogenic

Lid: yes, condensation rings, Sterile: +

Item no.	Growth area	Surface treatment	Sterile	Qty. inner / outer
655169		untreated	+	8 / 32
655167	53 mm ²	TC	+	8 / 32

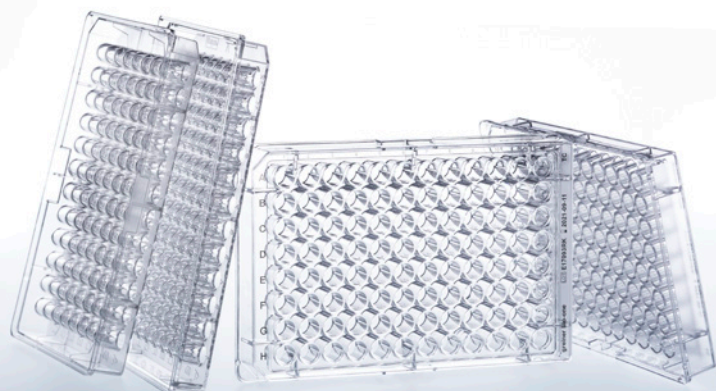

- / Application Note „Establishing a cell culture assay based on TR-FRET for screening G-Protein-coupled receptors“ (F074058)
- / Application Note „Selection of cell culture surfaces for the adipogenic differentiation of hMSCs“ (F010003)

CELLSTAR® CELL CULTURE MICROPLATES

Cell culture treated microplates are available in the following versions: 96, 384, 1536 well format.

Depending on the application, the well profile is a key feature in a 96 well cell culture microplate. The chimney well cell culture microplate has the same well profile as the standard F-bottom plate. The difference to the standard plate is the chimney-like arrangement of the wells i.e. each well stands on its own. Therefore the risk of contamination from sample material being carried over is minimised. Clear-bottom mi-

croplates have pigmented walls and a transparent thin film bottom, the so-called μ Clear® bottom. In contrast to our standard microplates with a solid polystyrene bottom, they are ideal for cell culture and microscopic applications using fluorescence or luminescence detection methods.

For many applications, a reduction of the sample volume is an important feature. 96 well half area microplates offer an interesting alternative here. They can be pipetted automatically as well as manually without any problem and allow a reduction of the sample volume up to 50 %.

- / Available with different cell culture surfaces for optimal cell culture conditions
- / Footprint compatible with automated systems
- / Alphanumeric well coding

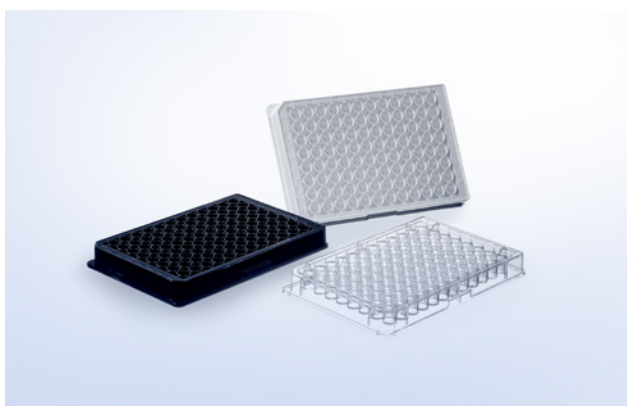

Cell Culture Microplates

96 Well

- / With U-bottom, V-bottom or F-bottom
- / Clear / black / white
- / Chimney well design, raised wells and condensation rings in lids prevent cross-contamination
- / Improved cell adhesion through physical surface treatment

STERILE

FREE OF
detectable
DNaseFREE OF
detectable
human DNAFREE OF
detectable
RNase

 non-
cytotoxic

 non-
pyrogenic

Well format: 96, Bottom: solid, Raw material: PS, Surface treatment: TC, Sterile: +

Item no.	Growth area / unit	Well profile	Product colour	Working volume (well)	Lid	Sterile	Qty. inner / outer
650160	35 mm ²	U-bottom	○ clear	40 µl - 280 µl	no	+	1 / 100
650180	35 mm ²	U-bottom	○ clear	40 µl - 280 µl	yes	+	1 / 100
651160	28 mm ²	V-bottom	○ clear	40 µl - 200 µl	no	+	1 / 100
651180	28 mm ²	V-bottom	○ clear	40 µl - 200 µl	yes	+	1 / 100
655160	34 mm ²	F-bottom / Chimney Well	○ clear	25 µl - 340 µl	no	+	1 / 100
655162	34 mm ²	F-bottom / Chimney Well	○ clear	25 µl - 340 µl	no	+	5 / 100
655180	34 mm ²	F-bottom / Chimney Well	○ clear	25 µl - 340 µl	yes, condensation rings	+	1 / 100
655182	34 mm ²	F-bottom / Chimney Well	○ clear	25 µl - 340 µl	yes, condensation rings	+	10 / 160
655073	34 mm ²	F-bottom / Chimney Well	○ white	25 µl - 340 µl	no	+	10 / 40
655083	34 mm ²	F-bottom / Chimney Well	○ white	25 µl - 340 µl	yes, condensation rings	+	8 / 32
655079	34 mm ²	F-bottom / Chimney Well	● black	25 µl - 340 µl	no	+	10 / 40
655086	34 mm ²	F-bottom / Chimney Well	● black	25 µl - 340 µl	yes, condensation rings	+	8 / 32

/ For selected products Greiner Bio-One also offers user-friendly bulk packaging.

/ Barcode labelling on request

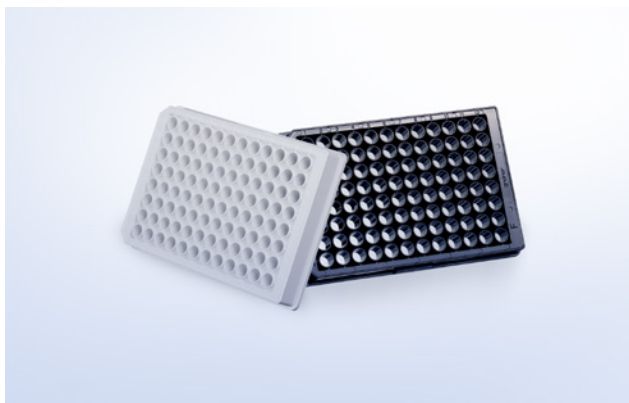

Cell Culture Microplates

96 Well - µClear®

Clear-bottom microplates have pigmented walls and a transparent thin film bottom, the so-called µClear® bottom. In contrast to our standard microplates with a solid polystyrene bottom, they are ideal for cell culture and microscopic applications using fluorescence or luminescence detection methods.

STERILE	FREE OF detectable DNase	FREE OF detectable human DNA	FREE OF detectable RNase	non-cytotoxic	non-pyrogenic
---------	--------------------------	------------------------------	--------------------------	---------------	---------------

Well format: 96, Growth area / unit: 34 mm², Well profile: F-bottom / Chimney Well, Bottom: µClear®, Raw material: PS, Surface treatment: TC, Working volume (well): 25 µl - 340 µl, Sterile: +

Item no.	Product colour	Lid	Sterile	Qty. inner / outer
655088	○ white	no	+	10 / 40
655098	○ white	yes, condensation rings	+	8 / 32
655087	● black	no	+	10 / 40
655090	● black	yes, condensation rings	+	8 / 32



Cell Culture Microplates

96 Well - Half Area

For many applications, a reduction of the sample volume is an important feature. 96 well half area microplates offer an interesting alternative here. They can be pipetted automatically as well as manually without any problem and allow a reduction of the sample volume up to 50 %.

STERILE	FREE OF detectable DNase	FREE OF detectable human DNA	FREE OF detectable RNase	non-cytotoxic	non-pyrogenic
---------	--------------------------	------------------------------	--------------------------	---------------	---------------

Well format: 96, Growth area / unit: 15 mm², Well profile: F-bottom, Raw material: PS, Surface treatment: TC, Plate design: half area, Working volume (well): 15 µl - 175 µl, Lid: yes, Sterile: +

Item no.	Bottom	Product colour	Sterile	Qty. inner / outer
675180	solid	○ clear	+	8 / 32
675083	solid	○ white	+	8 / 32
675086	solid	● black	+	8 / 32

Item no.	Bottom	Product colour	Sterile	Qty. inner / outer
675090	µClear®	● black	+	8 / 32

/ For selected products Greiner Bio-One also offers user-friendly bulk packaging.

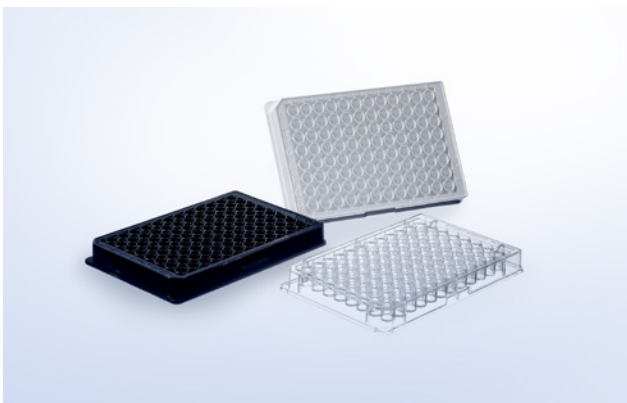

Cell Culture Microplates

96 Well - CELLCOAT®

- / Improved adhesion and cell proliferation
- / Reduced-serum or serum-free cultivation
- / Improved growth of primary cells

Well format: 96, Growth area / unit: 34 mm², Well profile: F-bottom / Chimney Well, Raw material: PS, Surface treatment: CELLCOAT®, Working volume (well): 25 µl - 340 µl, Lid: yes, condensation rings

Item no.	Bottom	Protein coating	Product colour	Qty. inner / outer
655955	solid	Collagen Type I	○ white	5 / 20
655950	solid	Collagen Type I	○ clear	5 / 20
655956	µClear®	Collagen Type I	● black	5 / 20
655940	solid	Poly-D-Lysine	○ clear	5 / 20
655944	µClear®	Poly-D-Lysine	○ white	5 / 20
655946	µClear®	Poly-D-Lysine	● black	5 / 20
655948	µClear®	Poly-D-Lysine	● black	20 / 120
655930	solid	Poly-L-Lysine	○ clear	5 / 20
655936	µClear®	Poly-L-Lysine	● black	5 / 20

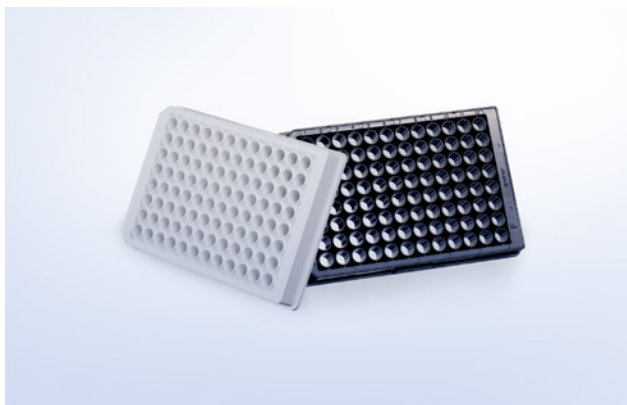

Cell Culture Microplates

96 Well - Advanced TC

The Advanced TC surface provides optimal conditions for the cultivation of sensitive and fastidious cells or the usage of restricted growth conditions.

- / Consistent and even cell attachment

STERILE	FREE OF detectable DNase	FREE OF detectable human DNA	FREE OF detectable RNase	non-cytotoxic	non-pyrogenic
---------	--------------------------	------------------------------	--------------------------	---------------	---------------

Well format: 96, Well profile: F-bottom / Chimney Well, Raw material: PS, Surface treatment: Advanced TC, Lid: yes, condensation rings, Sterile: +

Item no.	Growth area / unit	Bottom	Product colour	Plate design	Working volume (well)	Sterile	Qty. inner / outer
675986	15 mm ²	µClear®	○ clear	half area	15 µl - 175 µl	+	- / 32
655980	34 mm ²	solid	○ clear		25 µl - 340 µl	+	1 / 100
655983	34 mm ²	µClear®	○ white		25 µl - 340 µl	+	8 / 32
655986	34 mm ²	µClear®	● black		25 µl - 340 µl	+	8 / 32

Suspension Culture Microplates

96 Well



- / Hydrophobic surface, ideal for suspension cultures, hybridoma and embryonic stem cells
- / Solid bottom

STERILE	FREE OF detectable DNase	FREE OF detectable human DNA	FREE OF detectable RNase	non-cytotoxic	non-pyrogenic
---------	--------------------------	------------------------------	--------------------------	---------------	---------------

Well format: 96, Bottom: solid, Raw material: PS, Sterile: +

Item no.	Growth area / unit	Well profile	Surface treatment	Product colour	Working volume (well)	Lid	Sterile	Qty. inner / outer
650185		U-bottom	suspension	○ clear	40 µl - 280 µl	yes	+	60 / 240
655184		F-bottom / Chimney Well	suspension	○ clear	25 µl - 340 µl	yes, condensation rings	+	8 / 32
655185		F-bottom / Chimney Well	suspension	○ clear	25 µl - 340 µl	yes, condensation rings	+	60 / 240
650188	35 mm ²	U-bottom	TC	○ clear	40 µl - 280 µl	yes	+	- / 80

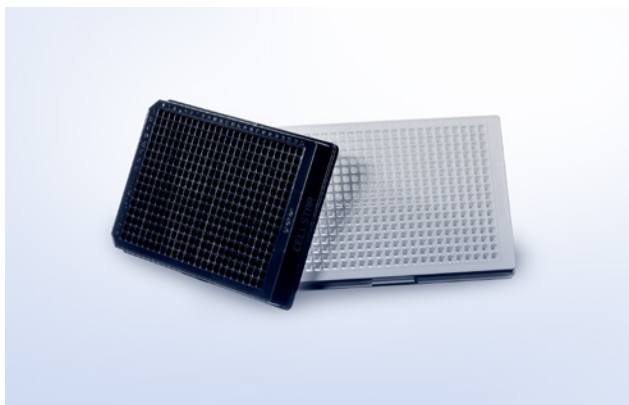

Cell Culture Microplates

384 Well

- / Clear / black / white
- / Solid bottom or μ Clear® film bottom
- / Barcode labelling on request
- / Alphanumeric well coding

Well format: 384, Growth area / unit: 10 mm², Well profile: F-bottom, Raw material: PS, Working volume (well): 15 μ l - 110 μ l

Item no.	Bottom	Surface treatment	Protein coating	Product colour	Total volume (well)	Lid	Sterile	Qty. inner / outer
781165	solid	TC		○ clear		no	+	10 / 40
781182	solid	TC		○ clear		yes	+	8 / 32
781073	solid	TC		○ white		no	+	10 / 40
781080	solid	TC		○ white		yes	+	8 / 32
781079	solid	TC		● black		no	+	10 / 40
781086	solid	TC		● black		yes	+	8 / 32
781093	μ Clear®	TC		○ white		no	+	10 / 40
781098	μ Clear®	TC		○ white		yes	+	8 / 32
781092	μ Clear®	TC		● black		no	+	10 / 40
781091	μ Clear®	TC		● black		yes	+	8 / 32
781090	μ Clear®	TC		● black		yes	+	20 / 120
781950	solid	CELLCOAT®	Collagen Type I	○ clear	131 μ l	yes		5 / 20
781956	μ Clear®	CELLCOAT®	Collagen Type I	● black	131 μ l	yes		5 / 20
781940	solid	CELLCOAT®	Poly-D-Lysine	○ clear	131 μ l	yes		5 / 20
781944	μ Clear®	CELLCOAT®	Poly-D-Lysine	○ white	131 μ l	yes		5 / 20
781946	μ Clear®	CELLCOAT®	Poly-D-Lysine	● black	131 μ l	yes		5 / 20
781948	μ Clear®	CELLCOAT®	Poly-D-Lysine	● black	131 μ l	yes		20 / 120
781930	solid	CELLCOAT®	Poly-L-Lysine	○ clear	131 μ l	yes		5 / 20
781936	μ Clear®	CELLCOAT®	Poly-L-Lysine	● black	131 μ l	yes		5 / 20
781983	μ Clear®	Advanced TC		○ white	131 μ l	yes	+	8 / 32
781986	μ Clear®	Advanced TC		● black	131 μ l	yes	+	8 / 32



Cell Culture Microplates

384 Well - Small Volume

HiBase

- / Perfect for top reading even at low working volumes
- / Savings in reagent similar to 1536 well microplates
- / Made of black / white polystyrene for fluorescence or luminescence measurements

Well format: 384, Growth area / unit: 2.7 mm², Well profile: F-bottom, Bottom: solid, Raw material: PS, Plate geometry: HiBase, Plate design: Small Volume, Working volume (well): 4 µl - 25 µl, Lid: yes

Item no.	Surface treatment	Protein coating	Product colour	Sterile	Qty. inner / outer
784080	TC		○ white	+	8 / 32
784086	TC		● black	+	8 / 32
784946	CELLCOAT®	Poly-D-Lysine	● black		5 / 30

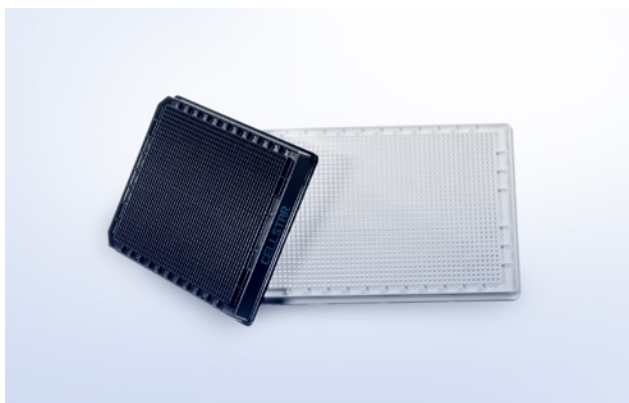

Cell Culture Microplates

1536 Well

- / Clear / black / white
- / Solid bottom or µClear® film bottom
- / Barcode labelling on request

Well format: 1536, Growth area / unit: 2.3 mm², Well profile: F-bottom, Raw material: PS, Working volume (well): 3 µl - 10 µl

Item no.	Bottom	Surface treatment	Protein coating	Product colour	Plate geometry	Lid	Sterile	Qty. inner / outer
782180	solid	TC		○ clear	HiBase	yes	+	1 / 32
783160	solid	TC		○ clear	LoBase	no	+	15 / 60
782073	solid	TC		○ white	HiBase	no	+	15 / 60
782080	solid	TC		○ white	HiBase	yes	+	10 / 40
782078	solid	TC		● black	HiBase	no	+	15 / 60
782086	solid	TC		● black	HiBase	yes	+	10 / 40
782093	µClear®	TC		○ white	HiBase	no	+	15 / 60
782092	µClear®	TC		● black	HiBase	no	+	15 / 60

Item no.	Bottom	Surface treatment	Protein coating	Product colour	Plate geometry	Lid	Sterile	Qty. inner / outer
782946	µClear®	CELLCOAT®	Poly-D-Lysine	● black	HiBase	yes		5 / 20

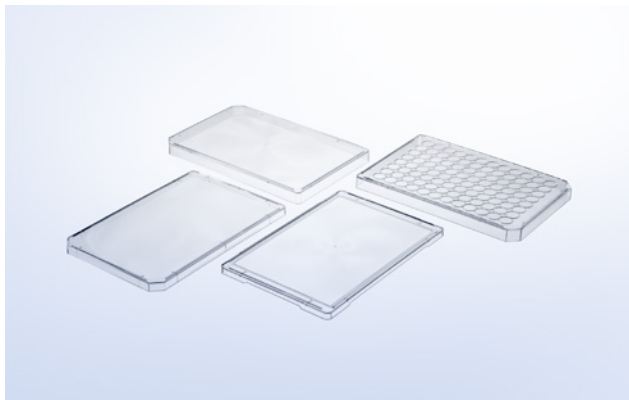

Lids

All sterile lids are non-cytotoxic.

Description: Lid

Item no.	Height	Raw material	Product colour	Condensation rings	Lid type	Sterile	Qty. inner / outer
656101	9 mm	PS	○ clear	no	high		1 / 100
656161	9 mm	PS	○ clear	no	high	+	1 / 100
656170	9 mm	PS	○ clear	yes	high		1 / 100
656171	9 mm	PS	○ clear	yes	high	+	1 / 100
656190	6 mm	PS	○ clear	no	flat		20 / 200
656191	6 mm	PS	○ clear	no	flat	+	20 / 200
691101	4.8 mm	PS	○ clear	no	ultra low		25 / 100
691161	4.8 mm	PS	○ clear	no	ultra low	+	25 / 100
656176	9 mm	PS	○ clear	yes	high	+	10 / 150
656197	9 mm	PS	○ clear	no	high		- / 150
656199	6 mm	PS	● black	no	flat		50 / 400
792891	4.3 mm	COC	○ clear	no	ultra low		30 / 120



- / Application Note: Cultivation of Suspension and Hybridoma Cells in CELLSTAR® CELLreactor Tubes (F073918)
- / Application Note: Superior protein yields in suspension CHO cells using FectoPRO™-mediated transient transfection in CELLSTAR® CELLreactor (F073926)

CELLSTAR® CELL CULTURE TUBES

CELLSTAR® CELLreactor tube can be used as small bioreactor for suspension and spheroid cell culture, facilitating miniaturisation of large-scale setups and maximising the number of parallel experiments. Each CELLreactor tube cap features several holes and a membrane with a pore size of 0.2 µm to guarantee maximal sterility while providing excellent gas exchange. In case the aeration has to be reduced, individual openings can be sealed.

Agitation of internal liquids is achieved with standard shaking lab equipment minimising foam formation and shearing forces

induced by integrated mixing devices. Compared to cell culture and spinner flask as well as other cultivation disposables, no transfer for cell harvest is required. Based on the conical design, the tubes fit in standard 15 ml / 50 ml centrifuge rotors and cells can be spun down in the same tube. In addition to cell culture applications, the CELLSTAR® CELLreactor tube can also be applied for the expansion of aerobic bacteria, yeast or other microorganisms in shaken cultures as well as storage of components and liquids requiring gas exchange.

- / Bioreactor for suspension and spheroid cells
- / Expansion of aerobic bacteria, yeast and microorganisms
- / Storage of components and liquids requiring gas exchange

**CELLreactor**

15 ml and 50 ml polypropylene tube with filter screw cap

- / For cultivation of suspension cells and expansion of aerobic microorganisms
- / Facilitates a high number of parallel experiments
- / Maximal sterility and excellent gas exchange
- / Conical tube design and in-tube harvest

STERILE

FREE OF
detectable
DNaseFREE OF
detectable
human DNAFREE OF
detectable
RNase
 non-
cytotoxic

 non-
pyrogenic

Graduation: yes, Writing field: yes, Raw material: PP, Bottom shape: conical, Cap design: filter screw cap, Sterile: +

Item no.	Height	Ø	Cap colour	Working volume	Nominal volume	Sterile	Qty. inner / outer
188241	120 mm	17 mm	● blue	1 ml - 5 ml	15 ml	+	20 / 500
227245	115 mm	30 mm	● blue	1 ml - 35 ml	50 ml	+	20 / 500

/ Application Note: Cultivation of Suspension and Hybridoma Cells in CELLSTAR® CELLreactor Tubes (F073918)

/ Application Note: Superior protein yields in suspension CHO cells using FectoPRO™-mediated transient transfection in CELLSTAR® CELLreactor (F073926)

**CELLSTAR®
Cell Culture Tubes**

- / Manufactured from crystal clear polystyrene
- / Improved cell adhesion through physical surface treatment
- / Available with screw cap, bayonet cap or two-position cap

STERILE

FREE OF
detectable
DNaseFREE OF
detectable
human DNAFREE OF
detectable
RNase
 non-
cytotoxic

 non-
pyrogenic

Raw material: PS, Surface treatment: TC, Sterile: +

Item no.	Height	Ø	Support skirt	Cap colour	Working volume	Nominal volume	Cap design	Sterile	Qty. inner / outer
120160	75 mm	12.4 mm	no		≤4 ml	4.5 ml		+	1 / 1,000
120190	75 mm	12.4 mm	no		≤4 ml	4.5 ml		+	25 / 2,000
163160	100 mm	17 mm	no	● red	≤12 ml	12 ml	screw cap	+	5 / 1,000
164160	100 mm	16.8 mm	yes	● red	≤12 ml	12 ml	bayonet cap	+	5 / 1,000
191160	95 mm	18 mm	no		≤12.5 ml	14 ml		+	1 / 750

/ The dimensions and volumes of our tubes are only nominal values. For exact dimensions and volumes, please refer to the product data sheets on our website: www.gbo.com.



/ Watch our video:



EASYSTRAINER CELL STRAINERS

With EASYstrainer cell strainers, Greiner Bio-One offers an innovative and user-friendly solution for the filtration of cell suspensions.

EASYstrainer can be used, for example, after enzymatic tissue digestion for primary cell isolation or for cell preparation prior to flow cytometry. The large cell strainers fit on all conical 50 ml tubes and are available with mesh sizes of 40, 70 and 100 μm . EASYstrainer Small fits 15 ml tubes as well as smaller tubes and reaction vessels. It is available with mesh sizes of 20, 40, 70 and 100 μm .

The stackability of EASYstrainers with different mesh sizes allows for the separation of cells with different sizes in one step. In addition, the upper part of EASYstrainer Small can be inverted. This allows retained cells to be rinsed out for further use. EASYstrainer makes working aseptically much easier: It can be held via a surrounding rim or a handle in order to avoid accidental contact with the sterile filter material. Additional safety is provided by the transparent blister packaging from which the strainers can be conveniently and aseptically removed.

- / Flexible fit, suitable for tubes from 1.5 ml to 50 ml
- / Available Mesh Sizes: 20, 40, 70 und 100 μm
- / No liquid overspill



EASYstrainer

- / Flexible fit, suitable for tubes from 1.5 ml to 50 ml
- / Handle and ridged skirt for improved aseptic handling
- / Venting slot for fast filtration
- / No liquid overspill
- / Single packaging reduces risk of contamination

STERILE	FREE OF detectable DNase	FREE OF detectable human DNA	FREE OF detectable RNase	non-cytotoxic	non-pyrogenic
recommended					

Sterile: +

Item no.	Description	Mesh size	Product colour	Sterile	Qty. inner / outer
542040	EASYstrainer for 50 ml tubes	40 µm	● green	+	1 / 50
542070	EASYstrainer for 50 ml tubes	70 µm	● blue	+	1 / 50
542000	EASYstrainer for 50 ml tubes	100 µm	● yellow	+	1 / 50
542120	EASYstrainer Small for tubes: 1.5 / 5 / 15 ml and 12x75 mm	20 µm	● red	+	1 / 50
542140	EASYstrainer Small for tubes: 1.5 / 5 / 15 ml and 12x75 mm	40 µm	● green	+	1 / 50
542170	EASYstrainer Small for tubes: 1.5 / 5 / 15 ml and 12x75 mm	70 µm	● blue	+	1 / 50
542100	EASYstrainer Small for tubes: 1.5 / 5 / 15 ml and 12x75 mm	100 µm	● yellow	+	1 / 50



The cultivation of cells as mass cultures has become increasingly important over the past few decades. Mass cell cultures are mainly used for the production of vaccines or recombinant proteins for therapeutic approaches.

MASS CELL CULTURE

/	CELLMASTER Cell Culture Roller Bottles.....	74
	Roller Bottles Polystyrene	75
	Roller Bottles Polyethylene Terephthalate(PET).....	76
/	CELLdisc Cell Culture Device	77
	CELLdisc 1 / 4 / 8 / 12 / 16 / 24 / 40 Layers	78
	CELLdisc External Filter.....	79
	CELLdisc Closed Filling Caps.....	80
	CELLhandle	81
	CELLstage Filling Accessory	81
	CELLlevator	82
	CELLring	82



/ For further information, please refer to our website: www.gbo.com



CELLMASTER CELL CULTURE ROLLER BOTTLES

Roller bottles made of polystyrene or PET range in size from 850 cm² to 4250 cm² growth area and are available either with standard or filter screw caps. The standard screw cap enables a tight closing and contamination-free cultivation. The filter screw cap contains a membrane with a pore size of 0.2 µm guarantees optimal protection against contamination. It provides a high gas exchange rate which enables a mass cultivation of cells using e.g. bicarbonate

buffer and CO₂.

The product range includes a short and a long form, labelled as X and XL, accordingly. Both sizes are available with a smooth or radially ribbed surface. The ribbed design increases the growth area of the roller bottle without changing space requirements. All roller bottles are sterilised by irradiation according to validated procedures (ISO 11137). Endotoxin testing is conducted in accordance with USP 85 with a tolerance level of 0.03 EU/ml.

- / PS or PET roller bottles
- / Different sizes with or without radially ribbed surface
- / Graduations from 200 to 2000 ml
- / Seamless production technique rules out leaking seams



Roller Bottles
Polystyrene

- / For adherent cell culture
- / Manufactured from crystal clear polystyrene
- / Certified USP Class VI end product testing
- / Lot number and expiry date on each bottle
- / Filter screw cap with 0.2 µm pore size

STERILE	FREE OF detectable DNase	FREE OF detectable human DNA	FREE OF detectable RNase	non-cytotoxic	non-pyrogenic
---------	--------------------------	------------------------------	--------------------------	---------------	---------------

Ø: 122 mm, Graduation: yes, Raw material: PS, Surface treatment: TC, Sterile: +

Item no.	Flask design	Height	Growth area	Cap colour	Surface	Total volume	Cap design	Sterile	Qty. inner / outer
680660	1 X	271 mm	850 cm ²	● blue	smooth	2,520 ml	screw cap	+	2 / 24
680665	1 X	271 mm	850 cm ²	● blue	smooth	2,520 ml	screw cap	+	24 / 24
680648	1 X	271 mm	850 cm ²	● blue	smooth	2,520 ml	screw cap	+	24 / 48
680658	1 X	271 mm	850 cm ²	● blue	smooth	2,520 ml	filter screw cap	+	2 / 24
680668	1 X	271 mm	850 cm ²	● blue	smooth	2,520 ml	filter screw cap	+	24 / 24
680645	1 X	271 mm	850 cm ²	● blue	smooth	2,520 ml	filter screw cap	+	24 / 48
681670	2.5 X	271 mm	2,125 cm ²	● blue	ribbed	2,300 ml	screw cap	+	2 / 24
681675	2.5 X	271 mm	2,125 cm ²	● blue	ribbed	2,300 ml	screw cap	+	24 / 24
681672	2.5 X	271 mm	2,125 cm ²	● blue	ribbed	2,300 ml	filter screw cap	+	2 / 24
682660	1 XL	500 mm	1,700 cm ²	● blue	smooth	4,970 ml	screw cap	+	1 / 12
682612	1 XL	500 mm	1,700 cm ²	● blue	smooth	4,970 ml	screw cap	+	12 / 12
682624	1 XL	500 mm	1,700 cm ²	● blue	smooth	4,970 ml	screw cap	+	12 / 24
682615	1 XL	500 mm	1,700 cm ²	● blue	smooth	4,970 ml	filter screw cap	+	12 / 12
682625	1 XL	500 mm	1,700 cm ²	● blue	smooth	4,970 ml	filter screw cap	+	12 / 24
682670	5 XL	500 mm	4,250 cm ²	● blue	ribbed	4,640 ml	screw cap	+	1 / 12
682672	5 XL	500 mm	4,250 cm ²	● blue	ribbed	4,640 ml	screw cap	+	12 / 24
682678	5 XL	500 mm	4,250 cm ²	● blue	ribbed	4,640 ml	filter screw cap	+	1 / 12

/ Thread enables quick opening with a 2/3 turn. Screw caps with larger knurls for improved grip and ease of opening / closing.

/ Sterile, individually packed screw caps: standard (item no. 383361) and filter (item no. 383382).



Roller Bottles

Polyethylene Terephthalate (PET)

- / For adherent cell culture
- / Certified USP Class VI end product testing
- / With standard screw cap

STERILE	FREE OF detectable DNase	FREE OF detectable human DNA	FREE OF detectable RNase	non-cytotoxic	non-pyrogenic
---------	--------------------------	------------------------------	--------------------------	---------------	---------------

Flask design: 1 X, Height: 271 mm, Ø: 116 mm, Growth area: 850 cm², Graduation: yes, Raw material: PET, Surface: smooth, Total volume: 2,300 ml, Cap design: screw cap, Sterile: +

Item no.	Cap colour	Sterile	Qty. inner / outer
680190	● blue	+	1 / 18
680195	● blue	+	30 / 30



/ Watch our video:



CELLDISC CELL CULTURE DEVICE

CELLdisc is a multilayer cell culture device covering a range of 250 cm² to 10,000 cm² growth area. The innovative ergonomic design provides a versatile system from research scale to industrial batches with a 40 % higher surface/volume ratio than conventional multilayer systems.

A centrally located ventilation channel assures uniform distribution of gas throughout the device whereas the wide opening port simplifies manual filling. The compact and robust cylindrical device is ideally suited for automation and upscaling of cell

cultures. For the connection of the individual layers a proprietary, particle, and adhesive free assembly technique is used and the complete end product is USP Class VI certified.

To guarantee an ideal cell culture environment CELLdisc is provided with two surface treatments: Beside the **TC surface** for standard cells and applications CELLdisc is also available with the **Advanced TC surface**, improving cultivation of sensitive cells, even under restricted growth conditions and increasing cellular adhesion, proliferation and transfection rates.

- / Mass Cell Culture
- / Antibody, virus and vaccine production
- / Production of recombinant or therapeutic proteins



CELLdisc

1 / 4 / 8 / 12 / 16 / 24 / 40 Layers

- / 40 % higher surface/volume ratio than comparable systems
- / Easy operation and minimal space occupation
- / Media exchange without contact to cell layers

STERILE

FREE OF
detectable
DNase

FREE OF
detectable
human DNA

FREE OF
detectable
RNase

 non-
cytotoxic

 non-
pyrogenic

Ø: 200 mm, Raw material: PS, Cap design: screw cap, Sterile: +

Item no.	Layers	Height	Growth area	Surface treatment	Cap colour	Working volume	Sterile	Qty. inner / outer
678101	1	61 mm	250 cm ²	TC	● red	15 ml - 50 ml	+	1 / 8
678104	4	93 mm	1,000 cm ²	TC	● red	60 ml - 200 ml	+	1 / 4
678108	8	135 mm	2,000 cm ²	TC	● red	120 ml - 400 ml	+	1 / 3
678112	12	177 mm	3,000 cm ²	TC	● red	180 ml - 600 ml	+	1 / 2
678116	16	220 mm	4,000 cm ²	TC	● red	240 ml - 800 ml	+	1 / 2
678124	24	304 mm	6,000 cm ²	TC	● red	360 ml - 1,200 ml	+	1 / 2
678140	40	474 mm	10,000 cm ²	TC	● red	600 ml - 2,000 ml	+	1 / 1
678904	4	93 mm	1,000 cm ²	Advanced TC	● blue	60 ml - 200 ml	+	1 / 4
678908	8	135 mm	2,000 cm ²	Advanced TC	● blue	120 ml - 400 ml	+	1 / 3
678912	12	177 mm	3,000 cm ²	Advanced TC	● blue	180 ml - 600 ml	+	1 / 2
678916	16	220 mm	4,000 cm ²	Advanced TC	● blue	240 ml - 800 ml	+	1 / 2
678924	24	304 mm	6,000 cm ²	Advanced TC	● blue	360 ml - 1,200 ml	+	1 / 2
678940	40	474 mm	10,000 cm ²	Advanced TC	● blue	600 ml - 2,000 ml	+	1 / 1



CELLdisc
External Filter

- / Triple-packed CELLdiscs, pre-assembled with external filters
- / USP VI certified venting filters, manufactured with reinforced hydrophobic PTFE membranes
- / A defined pore size of 0.2 µm prevents contamination and ensures sufficient airflow to the cells

STERILE	FREE OF detectable DNase	FREE OF detectable human DNA	FREE OF detectable RNase	non-cytotoxic	non-pyrogenic
---------	--------------------------	------------------------------	--------------------------	---------------	---------------

Feature: External Filter, Ø: 200 mm, Raw material: PS, Surface treatment: TC, Cap design: screw cap, Sterile: +

Item no.	Layers	Height	Growth area	Cap colour	Working volume	Sterile	Qty. inner / outer
678101-EXF	1	61 mm	250 cm ²	● red	15 ml - 50 ml	+	1 / 4
678104-EXF	4	93 mm	1,000 cm ²	● red	60 ml - 200 ml	+	1 / 3
678108-EXF	8	135 mm	2,000 cm ²	● red	120 ml - 400 ml	+	1 / 2
678112-EXF	12	177 mm	3,000 cm ²	● red	180 ml - 600 ml	+	1 / 2
678116-EXF	16	220 mm	4,000 cm ²	● red	240 ml - 800 ml	+	1 / 2
678124-EXF	24	304 mm	6,000 cm ²	● red	360 ml - 1,200 ml	+	1 / 2
678140-EXF	40	474 mm	10,000 cm ²	● red	600 ml - 2,000 ml	+	1 / 1

/ Assembled product is sterilized (SAL 10⁻⁶) to reduce risk of contamination



CELLdisc

Closed Filling Caps

- / Triple-packed CELLdiscs, pre-assembled with external filters and closed filling cap
- / Choice of single tubing (CF1) or double tubing (CF2) depending on desired emptying process
- / Tubing with MPC type connector for quick and safe connection /disconnection

STERILE

FREE OF
detectable
DNase

FREE OF
detectable
human DNA

FREE OF
detectable
RNase

non-
cytotoxic

non-
pyrogenic

Ø: 200 mm, Raw material: PS, Surface treatment: TC, Cap design: screw cap, Sterile: +

Item no.	Feature	Layers	Height	Growth area	Cap colour	Working volume	Sterile	Qty. inner / outer
678101-CF1	hose connector without Dip-In	1	61 mm	250 cm ²	● red	15 ml - 50 ml	+	1 / 4
678104-CF1	hose connector without Dip-In	4	93 mm	1,000 cm ²	● red	60 ml - 200 ml	+	1 / 3
678104-CF2	hose connector with Dip-In	4	93 mm	1,000 cm ²	● red	60 ml - 200 ml	+	1 / 3
678108-CF1	hose connector without Dip-In	8	135 mm	2,000 cm ²	● red	120 ml - 400 ml	+	1 / 2
678108-CF2	hose connector with Dip-In	8	135 mm	2,000 cm ²	● red	120 ml - 400 ml	+	1 / 2
678112-CF1	hose connector without Dip-In	12	177 mm	3,000 cm ²	● red	180 ml - 600 ml	+	1 / 2
678112-CF2	hose connector with Dip-In	12	177 mm	3,000 cm ²	● red	180 ml - 600 ml	+	1 / 2
678116-CF1	hose connector without Dip-In	16	220 mm	4,000 cm ²	● red	240 ml - 800 ml	+	1 / 2
678116-CF2	hose connector with Dip-In	16	220 mm	4,000 cm ²	● red	240 ml - 800 ml	+	1 / 2
678124-CF1	hose connector without Dip-In	24	304 mm	6,000 cm ²	● red	360 ml - 1,200 ml	+	1 / 2
678124-CF2	hose connector with Dip-In	24	304 mm	6,000 cm ²	● red	360 ml - 1,200 ml	+	1 / 2
678140-CF1	hose connector without Dip-In	40	474 mm	10,000 cm ²	● red	600 ml - 2,000 ml	+	1 / 1
678140-CF2	hose connector with Dip-In	40	474 mm	10,000 cm ²	● red	600 ml - 2,000 ml	+	1 / 1

/ Assembled product is sterilized (SAL 10⁻⁶) to reduce risk of contamination



CELLhandle

- / Gripping device for easy lifting and emptying of large-sized CELLdisc
- / Enables single-hand usage



Item no.	Qty. inner / outer
878074	1 / 1



CELLstage

Filling Accessory

- / Available for CELLdisc 4-24 layers and CELLdisc 40 layers
- / Creates the optimum angle and position for CELLdisc filling
- / Stainless steel allows multiple sterilization methods
- / Suitable for left- and right handed users



Item no.	Description	Qty. inner / outer
878072	for CD4 - CD24	1 / 1
878073	for CD40	1 / 1



CELLlevator

Easy and secured CELLdisc stacking

- / Maximum loading capacity 8 kg
- / Space saving storage
- / Autoclavable (120 °C, 2 bar)



Item no.	Qty. inner / outer
878071	1 / 9

/ For more information please see instruction for use No. F073253 on www.gbo.com



CELLring

Levelling ring

- / Ensures exact planar positioning of CELLdisc



Item no.	Qty. inner / outer
878075	- / 3



In 3D cell culture, cells form in a spatial orientation - similar to the body. This enables, for example, the replacement of animal experiments and - usually as high-throughput screening - research on drugs, stem cells and tumor development.

3D CELL CULTURE

/	CELLSTAR® Cell Culture Vessels Cell-Repellent Surface	86
	Cell Culture Dishes Cell-Repellent Surface	87
	Cell Culture Flasks Cell-Repellent Surface	87
	Multiwell Plates / Microplates Cell-Repellent Surface.....	88
	SCREENSTAR Microplates Cell-Repellent Surface.....	89
/	Magnetic 3D Cell Culture	90
	Spheroid Bioprinting 96 Well.....	91
	Spheroid Bioprinting 384 Well.....	91
	Magnetic Levitation 6 / 24 Well	92
	Screening 96 / 384 Well	93
	MagPen Single / 24 Well / 96 Well	93
	Consumables / Accessories Magnetic 3D Cell Culture.....	94
/	ThinCert® Cell Culture Inserts for 6, 12 and 24 Well Multiwell Plates	95
	ThinCert® Cell Culture Inserts 6 Well.....	96
	ThinCert® Cell Culture Inserts 12 Well	97
	ThinCert® Cell Culture Inserts 24 Well.....	98
	ThinCert® Plate 6 / 12 Well.....	98

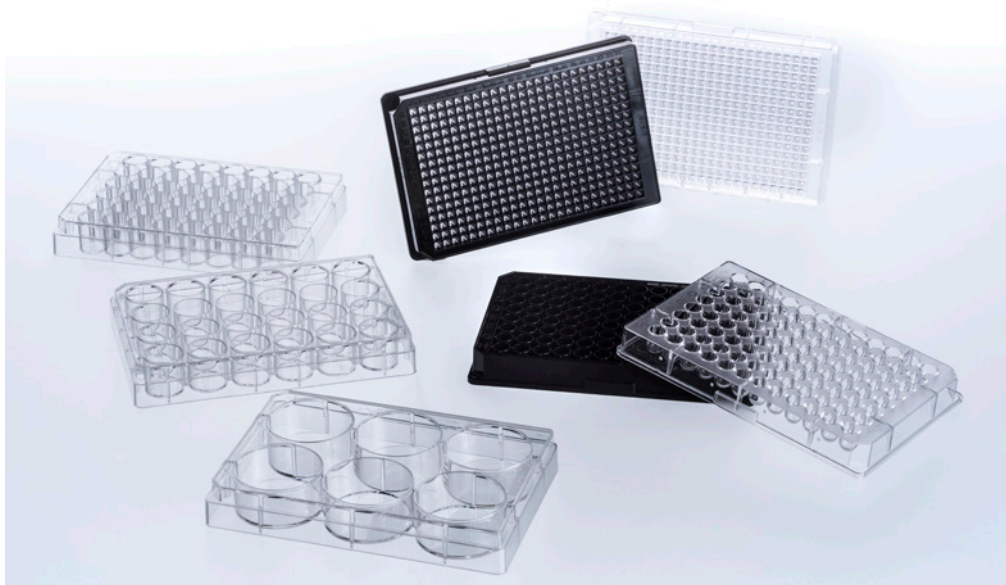

- / Forum No. 17: CELLSTAR® Cell Culture Vessels with Cell-Repellent Surface (F073777)
- / Application Report „Advantage of CELLSTAR® Cell Culture Vessels with Cell-Repellent Surface for 3-D Cell Culture in Hydrogels“ (F073792)

CELLSTAR® CELL CULTURE VESSELS CELL-REPELLENT SURFACE

Cell culture is an essential tool in drug discovery, tissue engineering, toxicology testing, stem cell research, as well as in basic research.

Beside conventional two-dimensional (2D) monolayer cell culture, 3D cell culture models are becoming a routine tool which enables the expression of extracellular matrix (ECM) components as well as the formation of cell-cell and cell-matrix interactions. These characteristics are important for replicating

in-vivo cell differentiation, proliferation, and function *in vitro*. Greiner Bio-One developed CELLSTAR® cell culture vessels with cell-repellent surface specifically for culturing in 3D. The cell-repellent surface effectively prevents cell adherence and therefore can promote the spontaneous formation of three-dimensional spheroids. Cell culture vessels with cell-repellent surface are also ideal platforms for long-term cultivation in hydrogels.

- / Spheroid and organoid culture
- / Aggregation of stem cells
- / Suspension culture of semi-adherent/adherent cell lines
- / 3D culture in hydrogels

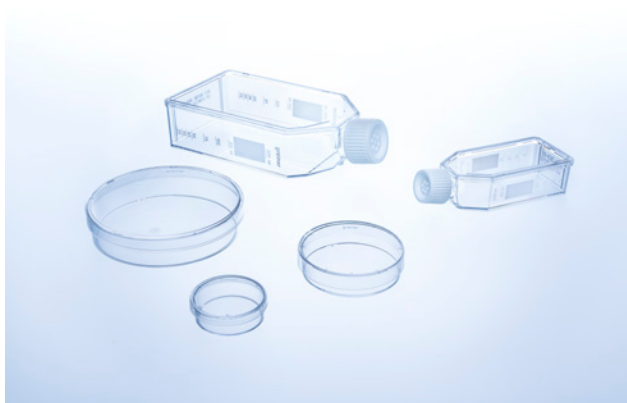

Cell Culture Dishes Cell-Repellent Surface

Cell culture vessels with cell-repellent surface reliably prevent cell attachment in suspension cultures of semi adherent / adherent cell lines where standard hydrophobic surfaces generally used for suspension culture are insufficient.



Raw material: PS, Surface treatment: cell-repellent, Vent neck: yes, Sterile: +

Item no.	Height	Ø nominal size	Working volume	Total volume	Sterile	Qty. inner / outer
627979	10 mm	35 mm	≤3 ml	10 ml	+	10 / 40
628979	15 mm	60 mm	6 ml - 7 ml	28 ml	+	10 / 20
664970	20 mm	100 mm	16 ml - 17 ml	100 ml	+	1 / 5

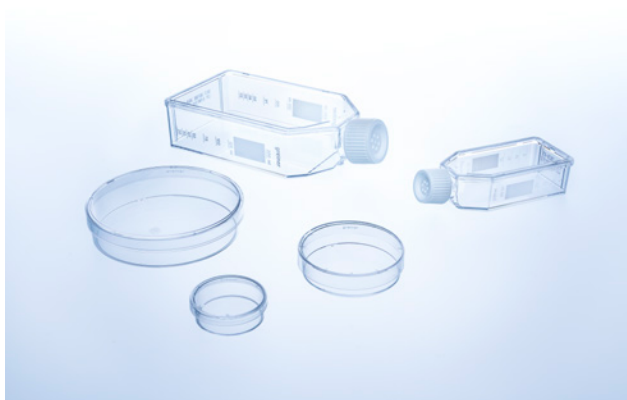

Cell Culture Flasks Cell-Repellent Surface

A cell-repellent surface reliably prevent cell attachment in suspension cultures of semi-adherent and adherent cell lines where standard hydrophobic surfaces generally used for suspension culture are insufficient.



Raw material: PS, Surface treatment: cell-repellent, Sterile: +

Item no.	Flask design	Cap colour	Total volume	Cap design	Sterile	Qty. inner / outer
690980	flat	○ white	50 ml	screw cap	+	10 / 20
690985	flat	○ white	50 ml	filter screw cap	+	10 / 20
658980	flat	○ white	250 ml	screw cap	+	5 / 15
658985	flat	○ white	250 ml	filter screw cap	+	5 / 15
660980	flat	○ white	550 ml	screw cap	+	5 / 5
660985	flat	○ white	550 ml	filter screw cap	+	5 / 5

Item no.	Flask design	Cap colour	Total volume	Cap design	Sterile	Qty. inner / outer
661980	high	○ white	650 ml	screw cap	+	4 / 4
661985	high	○ white	650 ml	filter screw cap	+	4 / 4

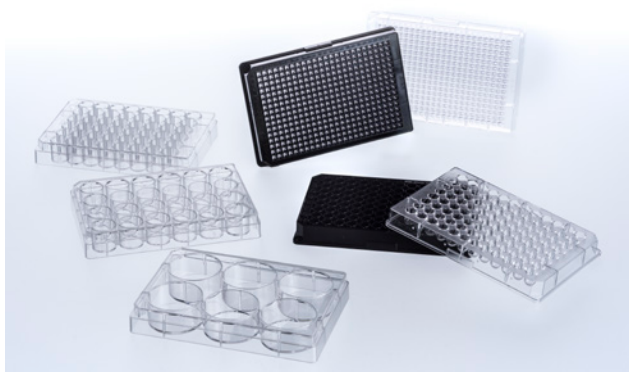

Multiwell Plates / Microplates Cell-Repellent Surface

- / 6 / 12 / 24 / 48 well multiwell plates available
- / 96 / 384 well plates with various well geometries and optional μ Clear® film bottom



Raw material: PS, Surface treatment: cell-repellent, Sterile: +

Item no.	Well format	Well profile	Bottom	Product colour	Total volume (well)	Working volume (well)	Lid	Sterile	Qty. inner / outer
657970	6	F-bottom	solid	○ clear	16.1 ml	2 ml - 5 ml	yes, condensation rings	+	1 / 5
665970	12	F-bottom	solid	○ clear	6.5 ml	2 ml - 4 ml	yes, condensation rings	+	1 / 5
677970	48	F-bottom	solid	○ clear	1.7 ml	0.5 ml - 1 ml	yes, condensation rings	+	1 / 5
650970	96	U-bottom	solid	○ clear	323 μ l	40 μ l - 280 μ l	yes, condensation rings	+	1 / 6
650979	96	U-bottom	solid	○ clear	323 μ l	40 μ l - 280 μ l	yes, condensation rings	+	8 / 32
651970	96	V-bottom	solid	○ clear	234 μ l	40 μ l - 200 μ l	yes, condensation rings	+	1 / 6
655970	96	F-bottom / Chimney Well	solid	○ clear	392 μ l	25 μ l - 340 μ l	yes, condensation rings	+	1 / 6
655976	96	F-bottom / Chimney Well	μ Clear®	● black	392 μ l	25 μ l - 340 μ l	yes, condensation rings	+	8 / 32
655976-SIN	96	F-bottom / Chimney Well	μ Clear®	● black	392 μ l	25 μ l - 340 μ l	yes, condensation rings	+	1 / 32
781970	384	F-bottom	solid	○ clear	131 μ l	15 μ l - 110 μ l	yes	+	1 / 60
781974	384	F-bottom	μ Clear®	○ white	131 μ l	15 μ l - 110 μ l	yes	+	8 / 32
781976	384	F-bottom	μ Clear®	● black	131 μ l	15 μ l - 110 μ l	yes	+	8 / 32
781976-SIN	384	F-bottom	μ Clear®	● black	131 μ l	15 μ l - 110 μ l	yes	+	1 / 32
787979	384	U-bottom	solid	○ clear	122 μ l	10 μ l - 90 μ l	yes	+	8 / 32

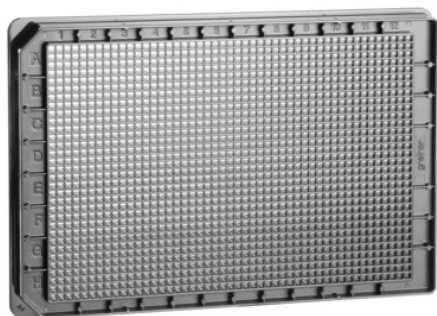

SCREENSTAR Microplates
Cell-Repellent Surface

- / For sophisticated microscopic applications and high content screening
- / Highly transparent cycloolefin film bottom
- / Adherent TC surface treatment

STERILE	FREE OF detectable DNase	FREE OF detectable human DNA	FREE OF detectable RNase	non-cytotoxic	non-pyrogenic
---------	--------------------------	------------------------------	--------------------------	---------------	---------------

Well format: 1536, Well profile: F-bottom, Bottom: Cycloolefin film, Raw material: COP, Surface treatment: cell-repellent, Lid: yes, Sterile: +

Item no.	Product colour	Plate geometry	Sterile	Qty. inner / outer
789979	● black	LoBase	+	17 / 68
782974	○ white	HiBase	+	10 / 40



- / Brochure "3D Cell Culture" (F071076)
- / For further information please refer to our new 3D cell culture blog series 3D Made Easy:



MAGNETIC 3D CELL CULTURE

The core technology of Greiner Bio-One's magnetic 3D cell culture is the magnetisation of cells with NanoShuttle-PL. The cells can be aggregated with magnetic forces, either by levitation or Bioprinting, to form structurally and biologically representative 3D models in vitro. NanoShuttle-PL consists of gold, iron oxide, and Poly-L-Lysine. These nanoparticles ($\varnothing < 50$ nm) magnetise cells by electrostatically attaching to cell membranes during an overnight static incubation. Magnetised cells will ap-

pear peppered with dark nanoparticles after incubation.

NanoShuttle-PL is biocompatible, having no effect on metabolism, proliferation and inflammatory stress. Additionally, it does not interfere with experimental techniques, such as fluorescence or Western blotting. With magnetised spheroids, solution addition and removal are made easy by using magnetic force to hold them in a stationary position during aspiration, thereby limiting spheroid loss.

- / 3D in a 2D workflow
- / Easy handling
- / Fast 3D tissue assembly
- / No sample loss
- / Scalable
- / Ready for automation

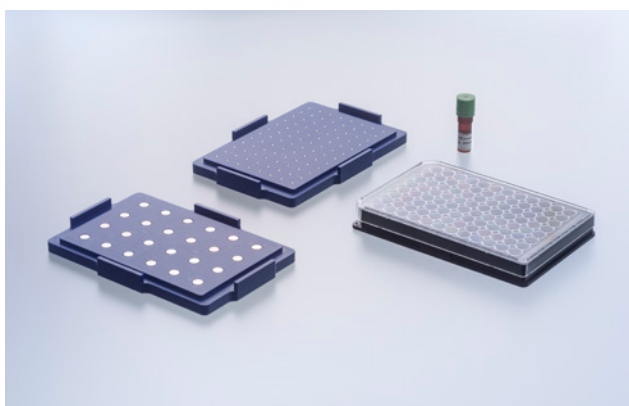

Spheroid Bioprinting

96 Well

Magnetized cells are brought together to form spheroids at the well bottom using weak magnetic forces.

Item no.	Description	Content kit	Qty. inner / outer
655840	96 Well Bioprinting Kit, clear	NanoShuttle-PL (3 vials), Spheroid Drive, Holding Drive, 96 well cell culture microplates (clear) with cell-repellent surface (2 x 655970)	1 / 1
655841	96 Well Bioprinting Kit, black, μ Clear [®]	NanoShuttle-PL (3 vials), Spheroid Drive, Holding Drive, 96 well cell culture microplates (black, μ clear [®]) with cell-repellent surface (2 x 655976-SIN)	1 / 1
655850	96 Well Ring Drive	96 Well Ring Drive for the formation of 3D ring structures	1 / 1
655830	96 Well Spheroid and Holding Drive	Spheroid Drive, Holding Drive	- / 1

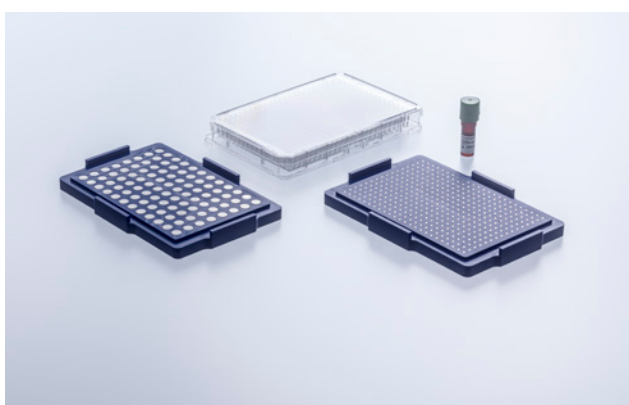

Spheroid Bioprinting

384 Well

Magnetized cells are brought together to form spheroids at the well bottom using weak magnetic forces.

Item no.	Description	Content kit	Qty. inner / outer
781840	384 Well Bioprinting Kit, clear	NanoShuttle-PL (2 vials), Spheroid Drive, Holding Drive, 384 well cell culture microplates (clear) with cell-repellent surface (2 x 781970)	1 / 1

Item no.	Description	Content kit	Qty. inner / outer
781841	384 Well Bioprinting Kit, black, µClear®	NanoShuttle-PL (2 vials), Spheroid Drive, Holding Drive, 384 well cell culture microplates (black, µClear®) with cell-repellent surface (2x 781976-SIN)	1 / 1
781850	384 Well Ring Drive	384 Well Ring Drive for the formation of 3D ring structures	1 / 1
781830	384 well spheroid and holding drive	Spheroid Drive, Holding Drive	- / 1

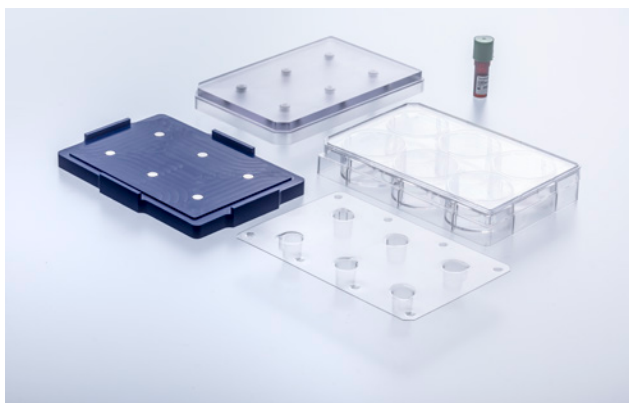

Magnetic Levitation

6 / 24 Well

Magnetised cells are levitated off the plate bottom by a magnet and rapidly form aggregates.

Item no.	Description	Content kit	Sterile	Qty. inner / outer
657840	6 Well Bio-Assembler Kit	Levitation Drive, Holding Drive, NanoShuttle-PL (2 Vials), 6 well cell culture multiwell plates (2 x 657970) and 6 Well Intermediate lid (2 x 657825) with cell-repellent surface		1 / 1
657825	6 Well Intermediate lid	Intermediate lid with cell-repellent surface	+	2 / 10
657830	6 Well Levitation and Holding Drive	Levitation Drive (1), Holding Drive (1)		- / 1
662840	24 Well Bio-Assembler Kit	Levitation Drive, Holding Drive, NanoShuttle-PL (2 Vials), 24 well cell culture multiwell plates (2 x 662970) and 24 Well Intermediate lid (2 x 662825) with cell-repellent surface		1 / 1
662825	24 Well Intermediate lid	Intermediate lid with cell-repellent surface	+	2 / 10
662830	24 well Levitation and Holding Drive	Levitation Drive (1), Holding Drive (1)		- / 1

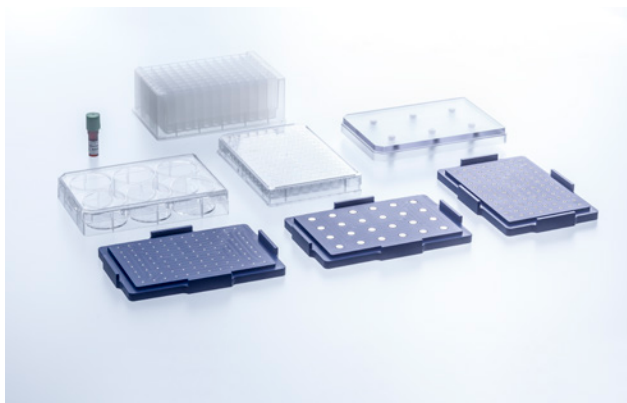

Screening
96 / 384 Well

Ideal kits for combining applications and examination methods.

Item no.	Description	Content kit	Qty. inner / outer
655846	96 Well BiO Assay Kit	NanoShuttle-PL (3 vials), 6 Well Levitation Drive, 96 Well Spheroid, Holding and Ring Drive, 96 Well Deep Well Plate, 6 Well cell culture multiwell plates with cell-repellent surface (2 x 657970), 96 Well cell culture microplates (clear) with cell-repellent surface (2 x 655970), 6 Well Intermediate Lid with cell-repellent surface (2 x 657825)	1 / 1
781846	384 Well BiO Assay Kit	NanoShuttle-PL (2 vials), 6 Well Levitation Drive, 384 Well Spheroid and Holding Drive, 96 Well Deep Well plate, 6 Well cell culture multiwell plates with cell-repellent surface (2 x 657970), 384 Well cell culture microplates (clear) with cell-repellent surface (2 x 781970), 6 Well Intermediate Lid with cell-repellent surface (2 x 657825)	1 / 1

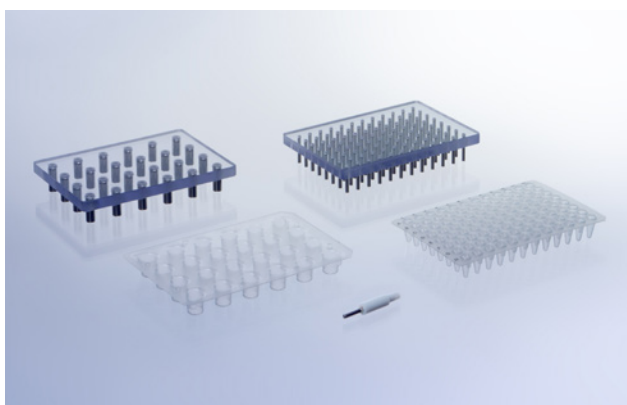

MagPen
Single / 24 Well / 96 Well

MagPen is a smart assistant for easy and fast transfer and collection of magnetized cell cultures by a simple "pick up-and-drop"-step.

Item no.	Description	Content kit	Sterile	Qty. inner / outer
657850	MagPen 3-pack	Teflon caps (3), magnets (3)		- / 3
657824	24 Well Multi-MagPen Kit	24 Well Multi-MagPen Drive and 24 Well Multi-MagPen Sleeve (2 x 651524) with cell-repellent surface		- / 1
651524	24 Well Multi-MagPen Sleeve	Multi-MagPen Sleeve with cell-repellent surface	+	1 / 10
657896	96 Well Multi-MagPen Kit	96 Well Multi-MagPen Drive und 96 Well Multi-MagPen Sleeve (2 x 61596) with cell-repellent surface		- / 1

Item no.	Description	Content kit	Sterile	Qty. inner / outer
651596	96 Well Multi-MagPen Sleeve	Multi-MagPen Sleeve with cell-repellent surface	+	1 / 10



Consumables / Accessories

Magnetic 3D Cell Culture

- / NanoShuttle-PL consists of gold, iron oxide and Poly-L-Lysine



Item no.	Description	Content kit	Qty. inner / outer
657841	NanoShuttle-PL	600 µl vials of NanoShuttle-PL (1)	- /1
657843	NanoShuttle-PL 3-pack	600 µl vials of NanoShuttle-PL (3)	- /3
657846	NanoShuttle-PL 6-pack	600 µl vials of NanoShuttle-PL (6)	- /6
657852	NanoShuttle-PL 12-pack	600 µl vials of NanoShuttle-PL (12)	- /12



- / Forum No. 8: ThinCert® cell culture products – Overview (F073017)
- / Application Note „Immuno cytochemistry“(F073100)
- / For further information and application notes please refer to our website: www.gbo.com



THINCERT® CELL CULTURE INSERTS FOR 6, 12 AND 24 WELL MULTIWELL PLATES

For advanced cell and tissue culture applications, Greiner Bio-One offers a broad range of membrane supports - ThinCert®.

Combining 6 different membrane specifications (pore size and density) in geometries to fit 6, 12 and 24 well plates, the ThinCert® cell culture inserts are suitable for a wide range of applications including transport, secretion and diffusion studies, migrational experiments, cytotoxicity testing, co-cultures, trans epithelial electric resist-

ance (TEER) measurements, as well as primary cell culture.

ThinCert® cell culture inserts are compatible with standard CELLSTAR® multiwell plates from Greiner Bio-One, and are pre-packed together with the requisite number of plates. The automated production process includes double optical control of each insert produced, ensuring that any biological contamination is avoided. The sterility of the single blisterpacked inserts and multiwell plates is ensured by irradiation.

- / Stable clear polystyrene housing
- / Sealed PET capillary pore membrane
- / Pre-configured multiwell plates with ThinCert® cell culture inserts available on request

3D Cell Culture

ThinCert® Cell Culture Inserts for 6, 12 and 24 Well Multiwell Plates



ThinCert® Cell Culture Inserts

6 Well

- / Hanging geometry
- / Improved cell adhesion through physical surface treatment
- / Simplified pipetting due to self-lift geometry
- / Enhanced pipetting access and gas exchange

STERILE

FREE OF
detectable
DNase

FREE OF
detectable
human DNA

FREE OF
detectable
RNase

 non-
cytotoxic

 non-
pyrogenic

Feature: 4 multiwell plates / box, Height: 16.25 mm, Ø internal: 24.85 mm, Ø external: 27.85 mm, Cultural surface: 452.4 mm², Surface treatment: TC, Working volume (ThinCert®): 1 ml - 3.6 ml, Working volume (well): 2 ml - 4.15 ml, Sterile: +

Item no.	Pore density	Ø pore	Optical membrane properties	Sterile	Qty. inner / outer
657640	1 x 10 ⁸ / cm ²	0.4 µm	translucent	+	1 / 24
657641	2 x 10 ⁸ / cm ²	0.4 µm	clear	+	1 / 24
657610	2 x 10 ⁸ / cm ²	1 µm	clear	+	1 / 24
657630	0,6 x 10 ⁶ / cm ²	3 µm	clear	+	1 / 24
657631	2 x 10 ⁸ / cm ²	3 µm	translucent	+	1 / 24
657638	0,15 x 10 ⁶ / cm ²	8 µm	translucent	+	1 / 24



ThinCert® Cell Culture Inserts

12 Well

- / Hanging geometry
- / Improved cell adhesion through physical surface treatment
- / Simplified pipetting due to self-lift geometry
- / Enhanced pipetting access and gas exchange

STERILE

FREE OF
detectable
DNase

FREE OF
detectable
human DNA

FREE OF
detectable
RNase

 non-
cytotoxic

 non-
pyrogenic

Feature: 4 multiwell plates / box, Height: 16.25 mm, Ø internal: 13.85 mm, Ø external: 15.85 mm, Cultural surface: 113.1 mm², Surface treatment: TC, Working volume (ThinCert®): 0.3 ml – 1 ml, Working volume (well): 1 ml – 2 ml, Sterile: +

Item no.	Pore density	Ø pore	Optical membrane properties	Sterile	Qty. inner / outer
665640	1 x 10 ⁸ / cm ²	0.4 µm	translucent	+	1 / 48
665641	2 x 10 ⁸ / cm ²	0.4 µm	clear	+	1 / 48
665610	2 x 10 ⁸ / cm ²	1 µm	clear	+	1 / 48
665630	0,6 x 10 ⁶ / cm ²	3 µm	clear	+	1 / 48
665631	2 x 10 ⁸ / cm ²	3 µm	translucent	+	1 / 48
665638	0,15 x 10 ⁶ / cm ²	8 µm	translucent	+	1 / 48

3D Cell Culture

ThinCert® Cell Culture Inserts for 6, 12 and 24 Well Multiwell Plates



ThinCert® Cell Culture Inserts

24 Well

- / Hanging geometry
- / Improved cell adhesion through physical surface treatment
- / Simplified pipetting due to self-lift geometry
- / Enhanced pipetting access and gas exchange

STERILE

FREE OF
detectable
DNase

FREE OF
detectable
human DNA

FREE OF
detectable
RNase

 non-
cytotoxic

 non-
pyrogenic

Feature: 2 multiwell plates / box, Height: 16.25 mm, Ø internal: 8.4 mm, Ø external: 10.4 mm, Cultural surface: 33.6 mm², Surface treatment: TC, Working volume (ThinCert®): 0.1 ml - 0.35 ml, Working volume (well): 0.4 ml - 1.2 ml, Sterile: +

Item no.	Pore density	Ø pore	Optical membrane properties	Sterile	Qty. inner / outer
662640	1 x 10 ⁸ / cm ²	0.4 µm	translucent	+	1 / 48
662641	2 x 10 ⁸ / cm ²	0.4 µm	clear	+	1 / 48
662610	2 x 10 ⁸ / cm ²	1 µm	clear	+	1 / 48
662630	0,6 x 10 ⁶ / cm ²	3 µm	clear	+	1 / 48
662631	2 x 10 ⁸ / cm ²	3 µm	translucent	+	1 / 48
662638	0,15 x 10 ⁶ / cm ²	8 µm	translucent	+	1 / 48



ThinCert® Plate

6 / 12 Well

- / Optimised for use with ThinCert® cell culture inserts
- / Deep wells for an increased volume of medium in air-lift culture
- / Notches for fixed insert position
- / Available in 6 and 12 well format

STERILE

FREE OF
detectable
DNase

FREE OF
detectable
human DNA

FREE OF
detectable
RNase

 non-
cytotoxic

 non-
pyrogenic

Height: 39.5 mm, Length: 129.5 mm, Width: 86.6 mm, Lid: yes, condensation rings, Sterile: +

Item no.	Well format	Working volume (well)	Sterile	Qty. inner / outer
657110	6	≤20 ml	+	1 / 50

Item no.	Well format	Working volume (well)	Sterile	Qty. inner / outer
665110	12	≤4 ml	+	1 / 60



Microscopy is a basic and important method, which is often used in research as well as in medical diagnostics. For this purpose, Greiner Bio-One offers a variety of tailor-made solutions, which guarantee optimal basic conditions for microscopic experiments.

PRODUCTS FOR MICROSCOPY

- / CELLview Dish Cell Culture Dish with
Glass Bottom 102
CELLview Dish 103

- / CELLview Slide Cell Culture Slide with
Glass Bottom 104
CELLview Slide 105

- / CELLview Plate Cell Culture Plate with
Glass Bottom 106
CELLview Plate 107

- / SCREENSTAR Microplates 108
SCREENSTAR Microplates 96 / 384 / 1536 Well
..... 109

- / SensoPlate Glass Bottom Microplates ..110
SensoPlate Glass Bottom Plates 24 / 96 / 384 /
1536 Well.....111



- / Application Note
„Protein localisation
using confocal laser
scanning microscopy“
(F073101)
- / Application Note
„Live cell imaging on
Golgi morphology using
the CELLview dish“
(F074048)

CELLVIEW DISH CELL CULTURE DISH WITH GLASS BOTTOM

CELLview Dish combines the convenience of a standard size 35 mm disposable plastic cell culture dish with the optical quality of glass, providing superior high-resolution microscopic images of in-vitro cultivated cultures.

It is made from high-grade polystyrene combined with an integrated glass bottom. The innovative design of the dish provides a single-plane, flat bottom with a consistent working distance and maximal planarity. Moreover, the dish bottom configuration facilitates optimal thermal conductivity and avoids thermal variations in heated platforms

used for live cell imaging. The subdivided version of CELLview Dish enables simultaneous multiplex analyses of different cell lines, various stimulations or diverse transfections. Quartering the cell culture dish provides four individual compartments with a growth area of approximately 1.9 cm², allowing minimisation of cells and reagents required per individual assay. In addition to the untreated glass surface, Greiner Bio-One provides a tissue culture surface as well as the Advanced TC surface modification to enhance the attachment of adherent cells, thus eliminating the need for protein coating.

- / TC and Advanced TC surface modification available
- / Maximal spectral transmission
- / No autofluorescence, no depolarisation of light

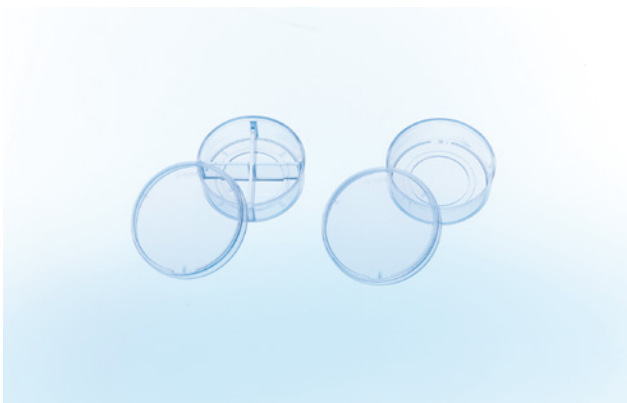

CELLview Dish

The CELLview cell culture dish combines the convenience of a standard size 35 mm disposable plastic cell culture dish with the optical quality of glass, providing superior high-resolution microscopic images of *in-vitro* cultivated cultures.

/ Embedded glass bottom for maximal planarity

STERILE	FREE OF detectable DNase	FREE OF detectable human DNA	FREE OF detectable RNase	non-cytotoxic	non-pyrogenic
---------	--------------------------	------------------------------	--------------------------	---------------	---------------

Ø: 35 mm, Bottom: glass, Vent nock: yes, Sterile: +

Item no.	Compartments	Growth area	Growth area / unit	Surface treatment	Working volume	Total volume	Total volume (well)	Working volume (well)	Sterile	Qty. inner / outer
627861	1	8.7 cm ²		untreated	2.5 ml - 5 ml	10 ml			+	10 / 40
627860	1	8.7 cm ²		TC	2.5 ml - 5 ml	10 ml			+	10 / 40
627965	1	8.7 cm ²		Advanced TC	2.5 ml - 5 ml	10 ml			+	10 / 40
627871	4		1.9 cm ²	untreated			1.5 ml	0.1 ml - 0.5 ml	+	10 / 40
627870	4		1.9 cm ²	TC			1.5 ml	0.1 ml - 0.5 ml	+	10 / 40
627975	4		1.9 cm ²	Advanced TC			1.5 ml	0.1 ml - 0.5 ml	+	10 / 40

/ Application Note „Protein localisation using confocal laser scanning microscopy“(F073101)

/ Application Note „Live cell imaging on Golgi morpholgy using the CELLview dish“(F074048)



/ For further information, please refer to our website: www.gbo.com



CELLVIEW SLIDE CELL CULTURE SLIDE WITH GLASS BOTTOM

CELLview Slide consists of a transparent slide with a black upper housing that effectively subdivides the slide into 10 compartments, which have been designed to mimic the size and layout of a standard 96 well microplate. Because of this standard layout, the slide is compatible with multichannel pipettes making it simple and efficient to use. Furthermore, the round well design helps to reduce meniscus effects for optimum results in cell culture and microscopic analysis. The slide has a 0.17 mm thin cover glass embedded

in its bottom for improved optical clarity and imaging. Embedding the cover glass guarantees an even focal plane which is a prerequisite for all high-speed and high-resolution microscopy applications. Furthermore, the black upper housing reduces cross talk between adjacent wells during fluorescence microscopy and the optical glass, which exhibits virtually no autofluorescence, allows for maximum spectral transmission without depolarisation of transmitted light.

- / 10 wells with alphanumeric coding
- / Black detachable compartmentalization
- / Well distance is equal to a 96 well microplate
- / Positioning notch for automated microscopy
- / Highly transparent achromatic borosilicate glass bottom



CELLview Slide

- / 10 wells with alphanumeric coding
- / Positioning notch for automated microscopy
- / Black detachable compartmentalization
- / Reduced meniscus effect due to round well design
- / Glass thickness: 0.17 mm

STERILE	FREE OF detectable DNase	FREE OF detectable human DNA	FREE OF detectable RNase	non-cytotoxic	non-pyrogenic
---------	--------------------------	------------------------------	--------------------------	---------------	---------------

Well format: 10, Height: 12.6 mm, Length: 75 mm, Width: 25 mm, Growth area / unit: 34 mm², Bottom: glass, Total volume (well): 440 µl, Sterile: +

Item no.	Surface treatment	Sterile	Qty. inner / outer
543078	TC	+	1 / 20
543079	TC	+	5 / 45
543978	Advanced TC	+	1 / 20
543979	Advanced TC	+	5 / 45

/ Sample packs are available on request.



- / For plates with an optical cycloolefin film bottom, please refer to our SCREENSTAR plates in this chapter.

CELLVIEW PLATE

CELL CULTURE PLATE WITH GLASS BOTTOM

CELLview glass bottom microplates are designed for demanding and high-resolution microscopic applications.

They consist of a cycloolefin-based black frame with a 0.17 mm thin borosilicate glass bottom providing superior images of in-vitro cultures. The optimised microplate geometry and

the recessed bottom facilitate imaging of all peripheral wells even with immersion objectives. The round conical well design reduces the meniscus effect in order to assure equal cellular distribution and constant imaging results. An appropriate surface treatment improves cellular attachment and growth.

- / Outstanding image quality and resolution
- / Cycloolefin-based frame with 0.17 mm glass bottom
- / Excellent optical transparency
- / Recessed well bottom facilitating the use of lenses with low working distance and high aperture
- / Compatible with advanced confocal microscopic systems



CELLview Plate

- / For outstanding image quality and resolution
- / Recessed well bottom facilitating the use of objectives with low working distance
- / Ditch at the perimeter can be filled with liquid to minimise edge effects and evaporation
- / Compatible with advanced automated microscopic systems

STERILE	FREE OF detectable DNase	FREE OF detectable human DNA	FREE OF detectable RNase	non-cytotoxic	non-pyrogenic
---------	--------------------------	------------------------------	--------------------------	---------------	---------------

Well format: 96, Growth area / unit: 33 mm², Well profile: F-bottom / Chimney Well, Bottom: glass, Raw material: COP, Working volume (well): 25 µl - 440 µl, Lid: yes, Sterile: +

Item no.	Surface treatment	Product colour	Sterile	Qty. inner / outer
655891	TC	● black	+	1 / 16
655981	Advanced TC	● black	+	1 / 16

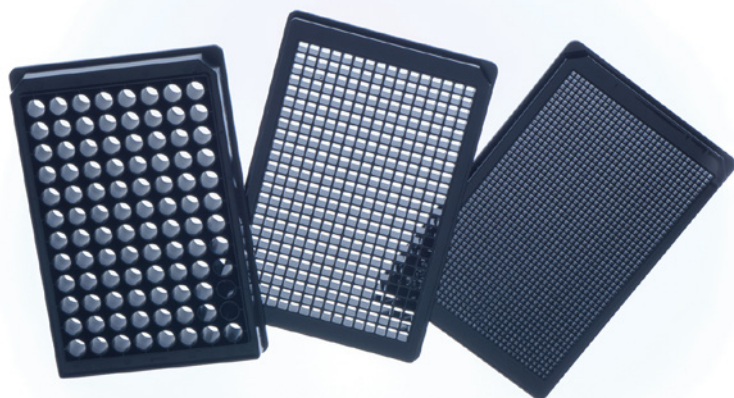

/ Forum No. 15:
SCREENSTAR: A 1536
Well Microplate for
High-Content and
High-Throughput
Screening (F073120)

SCREENSTAR MICROPLATES

SCREENSTAR are specialised microplates for sophisticated microscopic applications, in high content screening (HCS) or high-resolution microscopy with water and oil immersion objectives.

They combine outstanding glass-like optical properties with an excellent surface for adherent cell culture. Moreover, the plates display ex-

cellent optical properties with reduced autofluorescence in the lower UV range, low birefringence and a refractive index of 1.53 comparable to glass. SCREENSTAR microplates enable complete periphery access for high magnification objectives. They are entirely manufactured out of cycloolefin with a black pigmented cycloolefin frame and a 190 µm ultraclear cycloolefin film bottom.

- / 96 / 384 / 1536 well format
- / For sophisticated microscopic applications and high content screening
- / Highly transparent cycloolefin film bottom
- / Adherent TC surface treatment

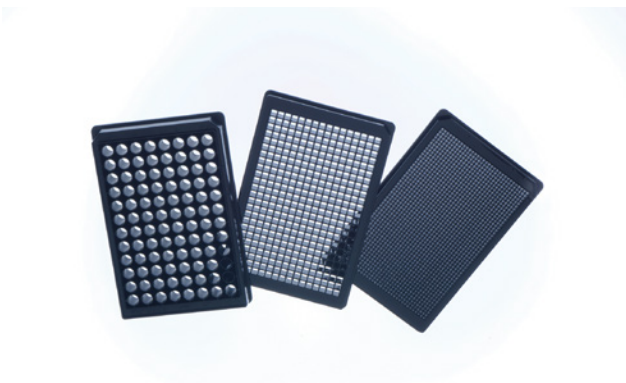

SCREENSTAR Microplates

96 / 384 / 1536 Well

- / For sophisticated microscopic applications and high content screening
- / Highly transparent cycloolefin film bottom
- / Adherent TC surface treatment

STERILE	FREE OF detectable DNase	FREE OF detectable human DNA	FREE OF detectable RNase	non-cytotoxic	non-pyrogenic
---------	--------------------------	------------------------------	--------------------------	---------------	---------------

Bottom: Cycloolefin film, Raw material: COP, Surface treatment: TC, Sterile: +

Item no.	Well format	Growth area / unit	Well profile	Product colour	Working volume (well)	Lid	Sterile	Qty. inner / outer
655866	96	33 mm ²	F-bottom / Chimney Well	● black	25 µl - 440 µl	yes	+	1 / 16
781866	384	8.1 mm ²	F-bottom	● black	10 µl - 110 µl	yes	+	8 / 32
789866	1536	2.1 mm ²	F-bottom	● black	3 µl - 15 µl	no	+	17 / 68

/ Forum No. 15: SCREENSTAR: A 1536 Well Microplate for High-Content and High-Throughput Screening (F073120)



/ For further information, please refer to our website: www.gbo.com



SENSOPLATE GLASS BOTTOM MICROPLATES

The research of biomolecular processes on the level of single molecules and in volume ranges equivalent to the size of a single bacterium is of immense importance, both in basic research and in industrial high-throughput screening. The combination of modern confocal optics, new fluorescent dyes, sensitive photomultipliers and improved data processing has revolutionised the technique of fluorescence correlation spectroscopy (FCS). Over the past few years this has led to its widespread application, and alongside the tech-

nological advances in hardware development, Greiner Bio-One worked hand-in-hand with customers and instrument suppliers to develop the glass bottom microplates. These better satisfy the requirements of fluorescence correlation spectroscopy with regards to optical clarity and deformation when compared to standard polystyrene plates.

The SensoPlate family was developed in a complete product line consisting of 24, 96, 384 and 1536 well glass bottom formats.

- / For fluorescence correlation spectroscopy and microscopic applications
- / 24 / 96 / 384 / 1536 well format
- / Black frame with highly transparent glass bottom
- / Glass bottom thickness of 175 μm is equivalent to the light path of standard coverslips
- / Sterile, with lid and single-packed



SensoPlate Glass Bottom Plates

24 / 96 / 384 / 1536 Well

- / For fluorescence correlation spectroscopy and microscopic applications
- / 24 / 96 / 384 / 1536 well format
- / Black frame with highly transparent glass bottom
- / Glass bottom thickness of 175 µm is equivalent to the light path of standard coverslips
- / Sterile, with lid and single-packed

Well profile: F-bottom, Bottom: glass, Raw material: PS, Surface treatment: untreated, Lid: yes

Item no.	Well format	Product colour	Plate geometry	Working volume (well)	Sterile	Qty. inner / outer
655892	96	● black		25 µl - 340 µl	+	1 / 16
781892	384	● black		10 µl - 130 µl	+	1 / 16
783892	1536	● black	LoBase	3 µl - 10 µl	+	1 / 16
781856	384	● black		10 µl - 130 µl		1 / 16

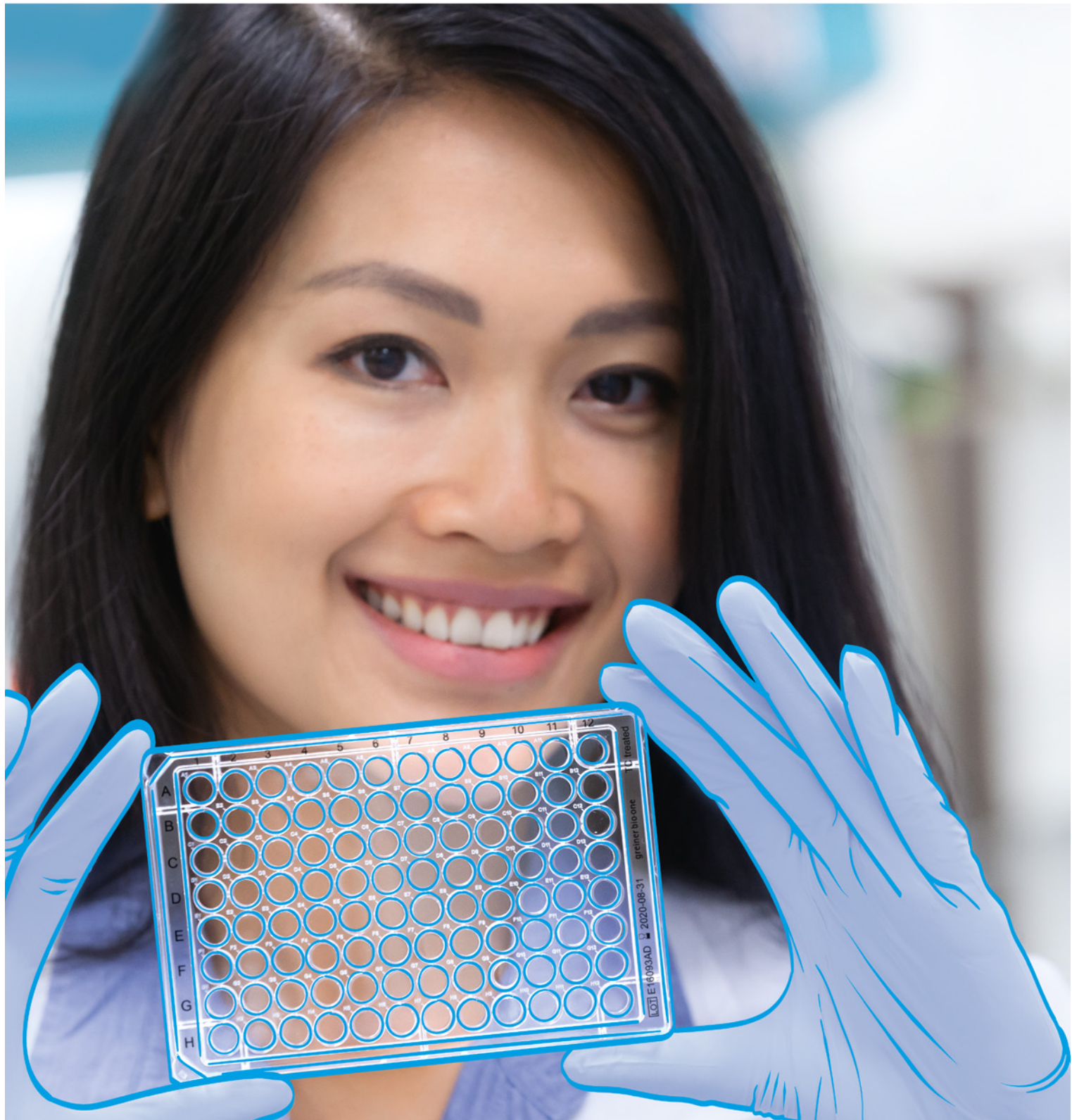

Continued progress in research and related technologies, such as microscopy, imaging, detection and liquid handling, has given rise to a wide variety of platforms used in basic science, biotechnology and pharmaceutical drug development. Today, researchers can select application-specific microplates among a broad range of products that differ in format, design, base material, colour and surface properties.

HTS-MICROPLATES

/ 96 Well Microplates	114		
96 Well Microplates Polystyrene	115		
96 Well Microplates Polystyrene - Half Area....	116		
96 Well Microplates Polypropylene.....	117		
/ 384 Well Microplates	118		
384 Well Microplates Polystyrene	119		
384 Well Microplates Polystyrene - Small Volume	120		
384 Well Microplates Polypropylene.....	121		
/ 1536 Well Microplates	122		
1536 Well Microplates	123		
/ Polypropylene Storage Plates	124		
96 Well MicroRack II Storage Racks, Tubes & Caps	125		
96 Well MASTERBLOCK® Polypropylene.....	125		
96 Well Storage Box	126		
384 Deep Well MASTERBLOCK® Polypropylene	126		
1536 Deep Well Microplates Polypropylene	127		
/ Microplates for Compound Storage	128		
Microplates for Compound Storage 384 and 1536 Well	129		
/ Non-binding Microplates	130		
Non-binding Microplates 96 Well	131		
Non-binding Microplates 384 and 1536 Well	131		
/ Streptavidin-coated Microplates.....	133		
			Streptavidin-coated Microplates 96 and 384 Well
			134
/ UV-Star® Microplates	135		
UV-Star® Microplates	136		
/ Lids / Sealers / CapMats	137		
Lids	138		
Sealers	138		
CapMats	139		
/ Protein Crystallisation Plates	140		
96 Well CrystalQuick / CrystalQuick Plus Plates	141		
24 Well ComboPlate CrystalBridge / Coverslips	141		

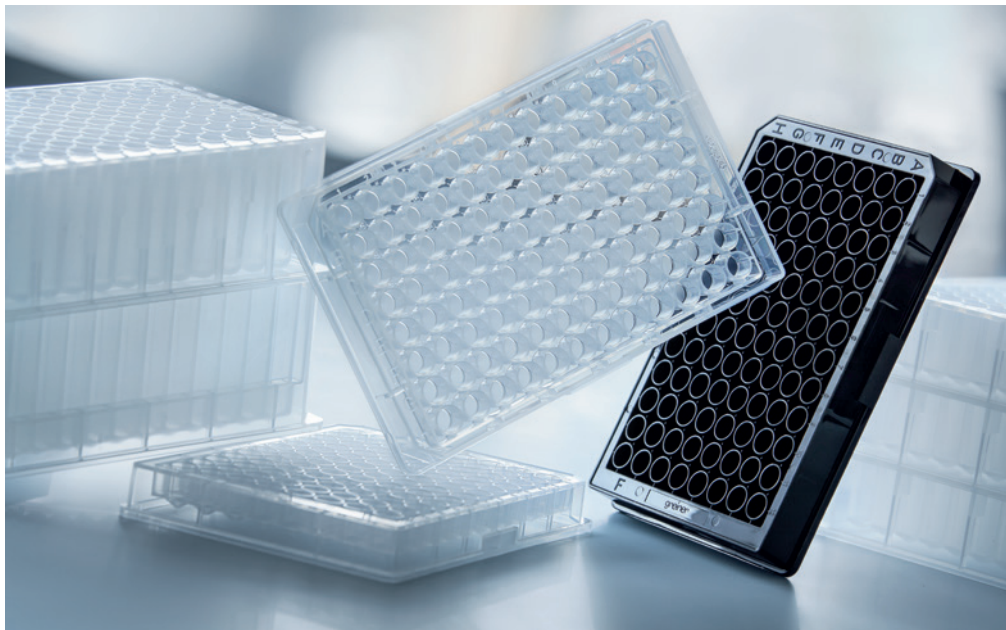

/ For details regarding the different well profiles, please refer to the technical appendix.

96 WELL MICROPLATES

Since its introduction in the 1960's applications for the 96 well microplate have continually increased to the extent that it is impossible to envisage modern research and industry without it today. Greiner Bio-One has been manufacturing microplates and strip microplates for diagnostics

and immunological research for over 40 years. A large number of different 96 well microplates is available in a wide variety of surface treatments. The spectrum ranges from clear bottom microplates and completely black or white microplates to UV-Star® products.

- / Available in polystyrene, polypropylene and cycloolefin
- / Clear / black / white
- / With U-bottom, V-bottom or F-bottom
- / Sterile / non-sterile
- / Non-treated or in high-binding quality
- / In non-binding quality

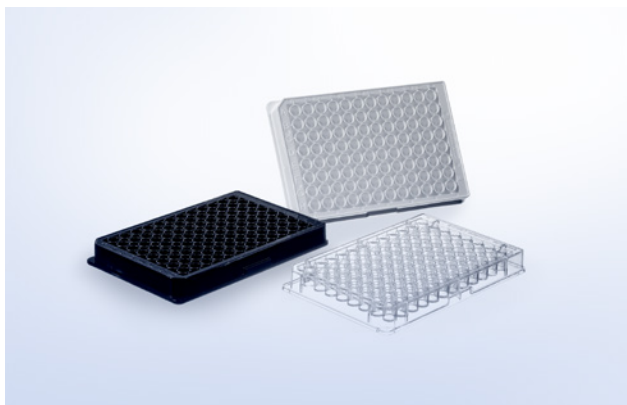

96 Well Microplates

Polystyrene

- / With U-bottom, V-bottom or F-bottom
- / Sterile / non-sterile
- / Non-treated or in high-binding quality
- / With solid bottom or μ Clear® film bottom

FREE OF
detectable
DNase

FREE OF
detectable
human DNA

FREE OF
detectable
RNase

 non-
pyrogenic

Well format: 96

Item no.	Well profile	Bottom	Raw material	Binding character- istic	Binding brand name	Surface treatment	Product colour	Working volume (well)	Sterile	Qty. inner / outer
650101	U-bottom	solid	PS			untreated	○ clear	40 μ l - 280 μ l		10 / 100
650162	U-bottom	solid	PS			untreated	○ clear	40 μ l - 280 μ l	+	25 / 375
650172	U-bottom	solid	PS			untreated	○ clear	40 μ l - 280 μ l		25 / 375
650161	U-bottom	solid	PS			untreated	○ clear	40 μ l - 280 μ l	+	2 / 100
651101	V-bottom	solid	PS			untreated	○ clear	40 μ l - 200 μ l		10 / 100
651161	V-bottom	solid	PS			untreated	○ clear	40 μ l - 200 μ l	+	2 / 100
655101	F-bottom	solid	PS			untreated	○ clear	25 μ l - 340 μ l		10 / 100
655161	F-bottom	solid	PS			untreated	○ clear	25 μ l - 340 μ l	+	2 / 100
655161	F-bottom	solid	PS			untreated	○ clear	25 μ l - 340 μ l	+	2 / 100
655075	F-bottom / Chimney Well	solid	PS			untreated	○ white	25 μ l - 340 μ l		10 / 40
655074	F-bottom / Chimney Well	solid	PS	high-binding	LUMITRAC 600		○ white	25 μ l - 340 μ l	+	10 / 40
655077	F-bottom / Chimney Well	solid	PS	high-binding	FLUOTRAC 600		● black	25 μ l - 340 μ l	+	10 / 40
655076	F-bottom / Chimney Well	solid	PS			untreated	● black	25 μ l - 340 μ l		10 / 40
655095	F-bottom / Chimney Well	μ Clear®	PS			untreated	○ white	25 μ l - 340 μ l		10 / 40
655094	F-bottom / Chimney Well	μ Clear®	PS	high-binding			○ white	25 μ l - 340 μ l	+	10 / 40

Item no.	Well profile	Bottom	Raw material	Binding characteristic	Binding brand name	Surface treatment	Product colour	Working volume (well)	Sterile	Qty. inner / outer
655097	F-bottom / Chimney Well	µClear®	PS	high-binding			● black	25 µl - 340 µl	+	10 / 40
655096	F-bottom / Chimney Well	µClear®	PS			untreated	● black	25 µl - 340 µl		10 / 40
651182									+	8 / 80



96 Well Microplates

Polystyrene - Half Area

- / Sterile / non-sterile
- / Reduction of sample volume by up to 50 %
- / Standardised pathlength (1 cm=170 µl, 0.5 cm=80 µl)
- / Non-treated or in high-binding quality
- / With solid bottom or µClear® film bottom

FREE OF detectable DNase

FREE OF detectable human DNA

FREE OF detectable RNase

 non-pyrogenic

Well format: 96, Well profile: F-bottom, Raw material: PS, Plate design: half area, Working volume (well): 15 µl - 175 µl, Lid: no

Item no.	Bottom	Binding characteristic	Surface treatment	Product colour	Sterile	Qty. inner / outer
675161	solid		untreated	○ clear	+	10 / 40
675101	solid		untreated	○ clear		10 / 40
675074	solid	high-binding		○ white	+	10 / 40
675075	solid		untreated	○ white		10 / 40
675077	solid	high-binding		● black	+	10 / 40
675076	solid		untreated	● black		10 / 40
675096	µClear®		untreated	● black		10 / 40

/ Further information on Half Area Microplates: Forum No. 16: 96 Well Half Area Microplates and their Application in Fluorescence, Luminescence and Transmission Measurements (F073121)



96 Well Microplates
Polypropylene

- / Ideally suited for the storage of active agents, DNA/RNA or stock cultures
- / High chemical resistance and temperature tolerance
- / Black plates for fluorescence polarisation

FREE OF
detectable
DNase

FREE OF
detectable
human DNA

FREE OF
detectable
RNase

 non-
pyrogenic

Well format: 96, Bottom: solid, Raw material: PP, Surface treatment: untreated, Lid: no

Item no.	Well profile	Product colour	Working volume (well)	Sterile	Qty. inner / outer
650201	U-bottom / Chimney Well	○ natural	50 µl - 300 µl		10 / 100
650261	U-bottom / Chimney Well	○ natural	50 µl - 300 µl	+	10 / 100
650209	U-bottom / Chimney Well	● black	50 µl - 300 µl		10 / 100
655201	F-bottom / Chimney Well	○ natural	25 µl - 370 µl		10 / 100
655209	F-bottom / Chimney Well	● black	25 µl - 370 µl		10 / 100
651201	V-bottom/Chimney Well	○ natural	50 µl - 335 µl		10 / 100
651209	V-bottom/Chimney Well	● black	50 µl - 335 µl		10 / 100
651261	V-bottom/Chimney Well	○ natural	50 µl - 335 µl	+	10 / 100

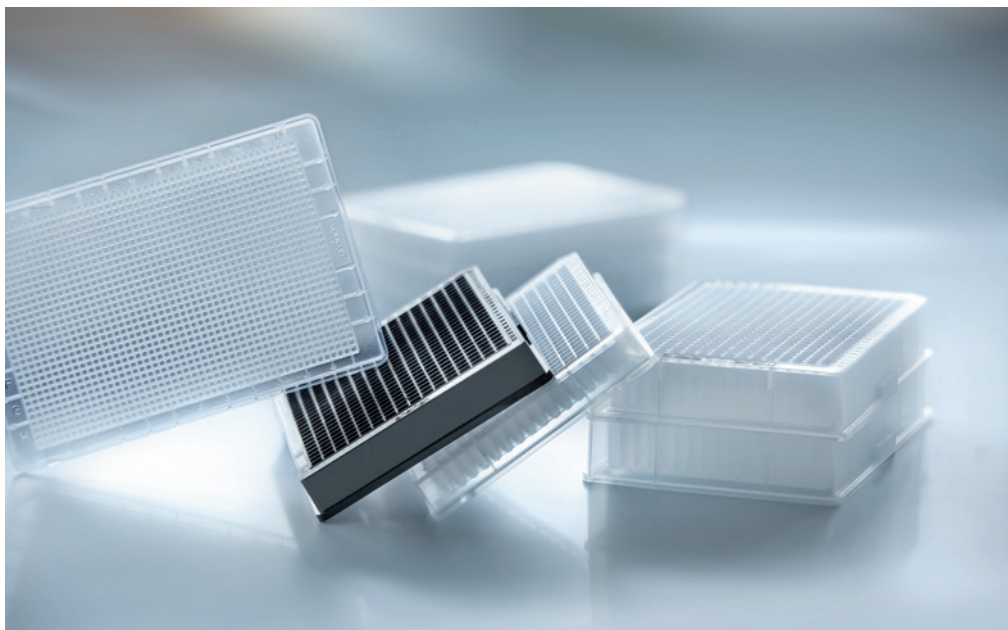

/ For cell culture treated microplates, please refer to chapter cell culture

384 WELL MICROPLATES

Drug screening has undergone rapid development over the past years.

The number of tests with new targets and the number of active agents to be tested is constantly increasing. Volume reduction, simple testing and cost savings are some of the highest priorities and high-format microplates with a low well volume are one of the most important tools in achieving this. One of the

first higher-format microplates was the 384 well plate, launched by Greiner Bio-One in 1994/1995. Compared with the 96 well microplate, the number of wells is quadrupled in this microplate, combined with a volume reduction from 382 μ l to 131 μ l. The well-to-well spacing is 4.5 mm (96 well plate: 9 mm). The external dimensions of the 384 well microplates are compatible with automated systems.

- / Available in polystyrene, polypropylene and cycloolefin
- / Clear / black / white
- / With F-bottom, V-bottom or as Small Volume option
- / Solid bottom or μ Clear® film bottom
- / Non-treated or in high-binding quality
- / In non-binding quality

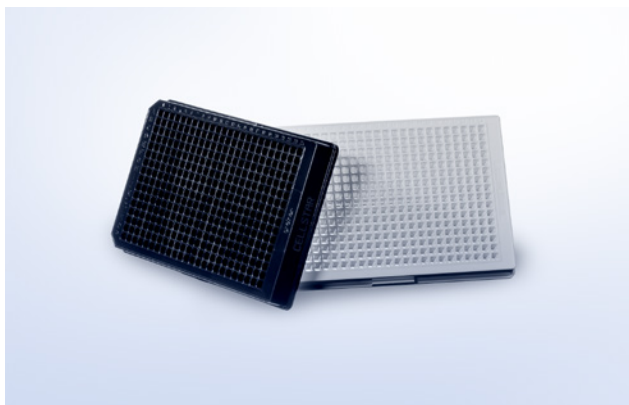

384 Well Microplates

Polystyrene

- / Solid bottom or μ Clear® film bottom
- / Sterile / non-sterile
- / Non-treated or in high-binding quality

FREE OF
detectable
DNase

FREE OF
detectable
human DNA

FREE OF
detectable
RNase

 non-
pyrogenic

Well format: 384, Well profile: F-bottom, Raw material: PS, Working volume (well): 15 μ l - 110 μ l
no lid

Item no.	Bottom	Binding characterisitc	Binding brand name	Surface treatment	Product colour	Lid	Sterile	Qty. inner / outer
781101	solid			untreated	○ clear	no		10 / 100
781074-25	solid	high-binding	LUMITRAC 600		○ white	no		25 / 150
781061	solid	high-binding			○ clear	no	+	10 / 40
781061-25	solid	high-binding			○ clear	no	+	25 / 150
781162	solid			untreated	○ clear	no	+	10 / 100
781185	solid			untreated	○ clear	yes	+	1 / 32
781186	solid			untreated	○ clear	yes	+	8 / 32
781074	solid	high-binding	LUMITRAC 600		○ white	no	+	10 / 40
781075	solid			untreated	○ white	no		10 / 40
781077-25	solid		FLUOTRAC 600		● black	no		25 / 150
781077	solid	high-binding	FLUOTRAC 600		● black	no	+	10 / 40
781075-25	solid			untreated	○ white	no		25 / 150
781076	solid			untreated	● black	no		10 / 40
781095	μ Clear®			untreated	○ white	no		10 / 40
781097	μ Clear®	high-binding			● black	no	+	10 / 40
781096	μ Clear®			untreated	● black	no		10 / 40

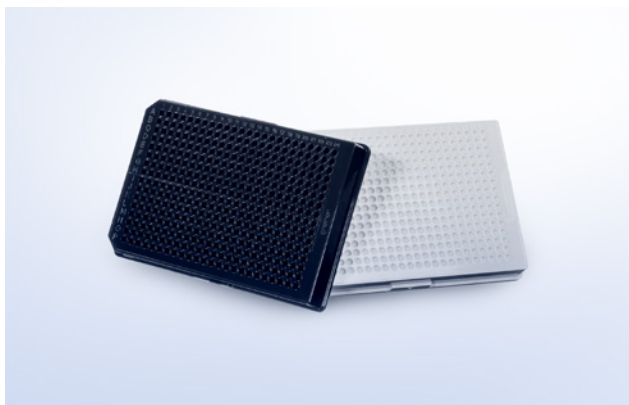

384 Well Microplates

Polystyrene - Small Volume

- / Perfect for top reading even at low working volumes
- / Savings in reagent similar to 1536 well microplates
- / Made of clear / black / white polystyrene for transmission, fluorescence or luminescence measurements

FREE OF
detectable
DNase

FREE OF
detectable
human DNA

FREE OF
detectable
RNase

 non-
pyrogenic

Well format: 384, Plate design: Small Volume
no lid

Item no.	Well profile	Bottom	Raw material	Binding characteristics	Binding brand name	Surface treatment	Product colour	Plate geometry	Working volume (well)	Qty. inner / outer
784209		solid	PP			untreated	● black	Deep Well		10 / 100
788101		solid	PS			untreated	○ clear	LoBase	4 µl - 25 µl	10 / 80
784074	F-bottom	solid	PS	high-binding	LUMITRAC 600		○ white	HiBase	4 µl - 25 µl	10 / 40
784075	F-bottom	solid	PS			untreated	○ white	HiBase	4 µl - 25 µl	10 / 40
784075-25	F-bottom	solid	PS			untreated	○ white	HiBase	4 µl - 25 µl	25 / 150
784076	F-bottom	solid	PS			untreated	● black	HiBase	4 µl - 25 µl	10 / 40
784077	F-bottom	solid	PS	high-binding	FLUOTRAC 600		● black	HiBase	4 µl - 25 µl	10 / 40
784076-25	F-bottom	solid	PS			untreated	● black	HiBase	4 µl - 25 µl	25 / 150
788095		µClear®	PS	med.-binding			○ white	LoBase	4 µl - 25 µl	10 / 80
788096		µClear®	PS	med.-binding			● black	LoBase		10 / 80

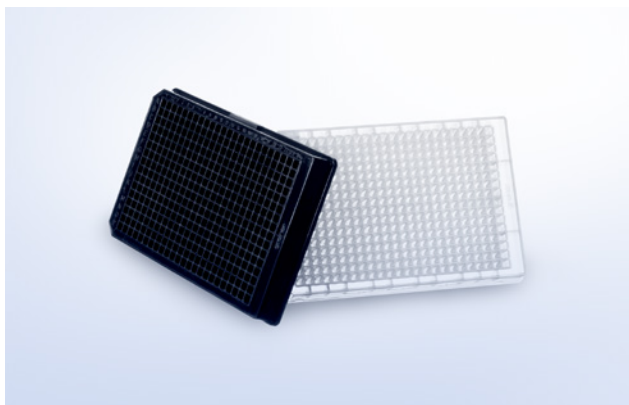

384 Well Microplates

Polypropylene

- / Ideally suited for the storage of active agents, DNA/RNA or stock cultures
- / High chemical resistance and temperature tolerance
- / Available natural or black
- / Item No. 781201-906 for Acoustic Liquid Handling

FREE OF
detectable
DNase

FREE OF
detectable
human DNA

FREE OF
detectable
RNase

 non-
pyrogenic

Well format: 384, Bottom: solid, Raw material: PP, Surface treatment: untreated

Item no.	Well profile	Product colour	Plate geometry	Plate design	Working volume (well)	Lid	Sterile	Qty. inner / outer
781201	F-bottom	○ natural			15 µl - 145 µl	no		10 / 100
784201	V-bottom	○ natural	Deep Well	Small Volume	1 µl - 90 µl	no		10 / 100
781207	F-bottom	○ white			15 µl - 145 µl	no		10 / 100
781281	V-bottom	○ natural			13 µl - 120 µl		+	10 / 100
781201-906	F-bottom	○ natural			15 µl - 145 µl	no		10 / 100
781209	F-bottom	● black			15 µl - 145 µl	no		10 / 100
781280	V-bottom	○ natural			13 µl - 120 µl	no		10 / 100
781261	F-bottom	○ natural			15 µl - 145 µl	no	+	10 / 100



/ For cell culture treated microplates, please refer to chapter cell culture

1536 WELL MICROPLATES

The highest possible degree of automation, optimal performance and cost savings continue to be the requirements placed on microplates for high-throughput screening.

In 1997, shortly after the launch of the 384 well microplates, Greiner Bio-One was the first manufacturer to introduce another innovative microplate format – the 1536 well microplate. The external dimensions were

the same as those used in the 96 well and 384 well microplates. However, to utilise the available space most efficiently, the number of wells was increased four-fold from 384 to 1536.

Close cooperation with numerous users has now led to the development of a broad product range, and the constant drive towards improvements in quality has, for example, led to a reduction in curvature of the plates to < 100 µm.

- / Available in polystyrene, polypropylene and cycloolefin
- / Clear / black / white
- / HiBase for top-reading applications
- / Solid bottom or µClear® film bottom
- / Sterile / non-sterile
- / Non-treated or in high-binding quality

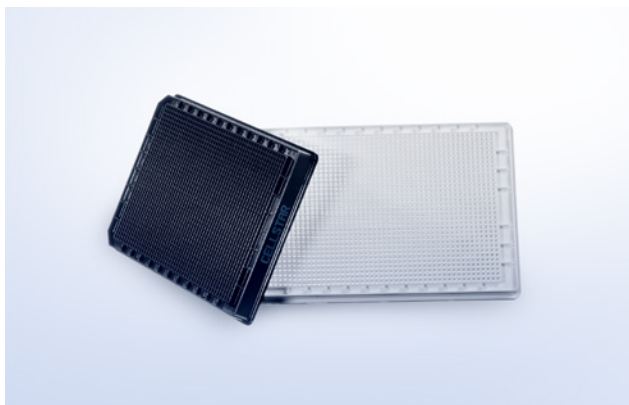

1536 Well Microplates

- / Solid bottom or μ Clear® film bottom
- / Sterile / non-sterile
- / Non-treated or in high-binding quality

FREE OF
detectable
DNase

FREE OF
detectable
human DNA

FREE OF
detectable
RNase

 non-
pyrogenic

Well format: 1536, Well profile: F-bottom, Raw material: PS,
no lid

Item no.	Bottom	Binding characterisitic	Binding brand name	Surface treatment	Product colour	Plate geometry	Working volume (well)	Sterile	Qty. inner / outer
782101	solid			untreated	○ clear	HiBase	3 μ l - 10 μ l		15 / 60
782061	solid	high-binding	MICROLON 600		○ clear	HiBase	3 μ l - 10 μ l	+	15 / 60
782075	solid			untreated	○ white	HiBase	3 μ l - 10 μ l		15 / 60
782074	solid	high-binding	LUMITRAC 600		○ white	HiBase	3 μ l - 10 μ l	+	15 / 60
782076	solid			untreated	● black	HiBase	3 μ l - 10 μ l		15 / 60
782077	solid	high-binding	FLUOTRAC 600		● black	HiBase	3 μ l - 10 μ l	+	15 / 60
782095	μ Clear®			untreated	○ white	HiBase	3 μ l - 10 μ l		15 / 60
782097	μ Clear®	high-binding			● black	HiBase	3 μ l - 10 μ l	+	15 / 60
782096	μ Clear®			untreated	● black	HiBase	3 μ l - 10 μ l		15 / 60
783076	solid	med.-binding	FLUOTRAC 200		● black	LoBase			15 / 60
783092	μ Clear®			TC	● black	LoBase		+	15 / 60
783096	μ Clear®				● black	LoBase			15 / 60

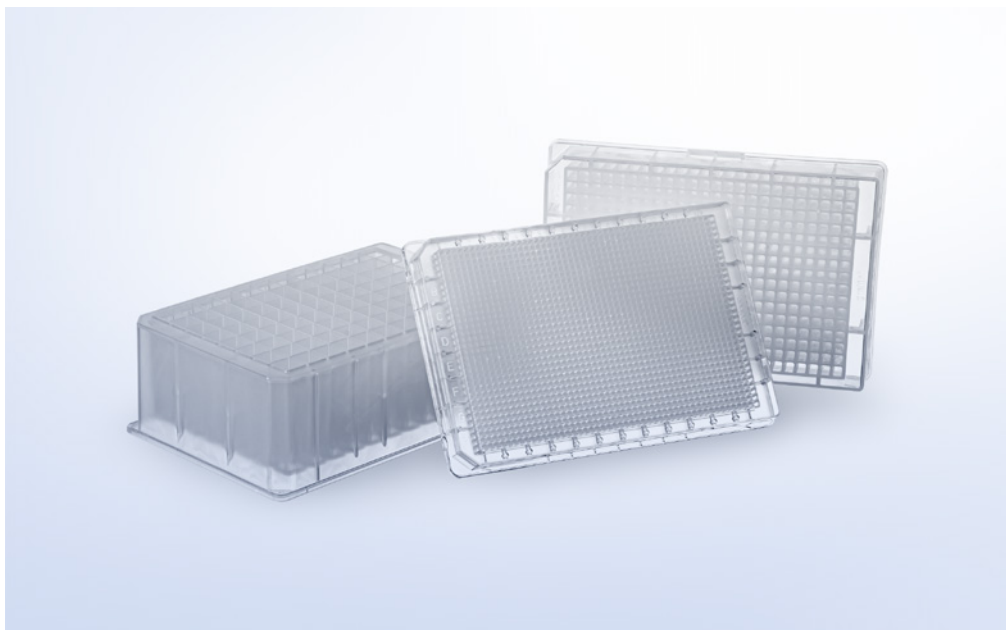

- / Compound storage plates for acoustic liquid handling can also be found in this chapter.

POLYPROPYLENE STORAGE PLATES

Greiner Bio-One polypropylene microplates are perfect storage plates for active agents, patient samples or biomolecules.

Their most important properties are biological inertness, resistance to numerous solvents commonly used in the laboratory, such as DMSO and high temperature resistance. The footprint

is compatible with automated systems.

The microplates are also characterised by elevated well walls which make it possible to easily seal them. The portfolio ranges from the 96 well MASTERBLOCK® with volumes of 0.5 ml, 1 ml or 2 ml over a MASTERBLOCK® with 384 wells or 1536 wells up to the 96 well storage box.

- / Ideally suited for the storage of active agents, DNA/RNA or stock cultures
- / High chemical resistance and temperature tolerance

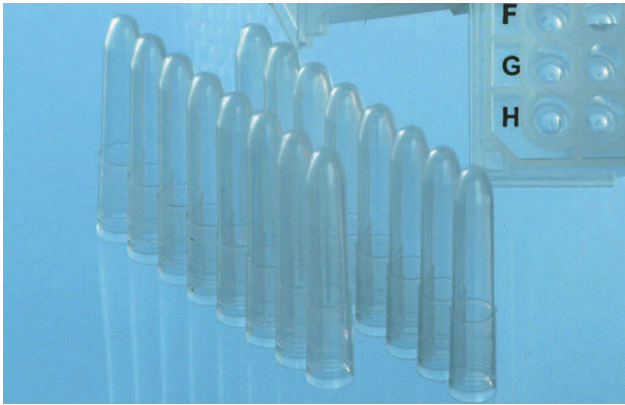

96 Well MicroRack II Storage Racks, Tubes and Caps

- / Cost-effective, inert polypropylene storage rack
- / Will withstand temperature extremes
- / Available as loose components or pre-assembled

Item no.	Description	Sterile	Qty. inner / outer
975271	Rack with 8-tube strips		10 / 100
975270	Rack with individual tubes		10 / 100
975275	Rack with individual tubes	+	10 / 100
102280	Individual tubes		- /10.000
102285	8-tube strips		- /1.250
102250	12-tube strips		- /800
365280	8-cap strips		500 / 1,250
365281	8-cap strips	+	125 / 1,250
365250	12-cap strips		- /800
365251	12-cap strips	+	- /800

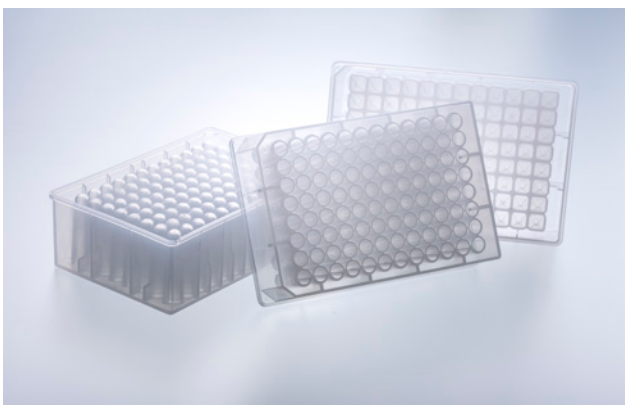

96 Well MASTERBLOCK® Polypropylene

- / Ideal for storing non-human sample material and cultivating bacteria / yeast
- / Uniform external dimensions and tolerances
- / Alphanumeric well coding
- / Sealable with adhesive films and heat sealers
- / Sealable with CapMats

FREE OF detectable DNase FREE OF detectable human DNA FREE OF detectable RNase  non-pyrogenic

Well format: 96, Bottom: solid, Raw material: PP

Item no.	Well profile	Product colour	Total volume (well)	Lid	Sterile	Qty. inner / outer
780201	U-bottom	○ natural	1 ml	CapMat 381070, 381061		1 / 50
780210	U-bottom	○ natural	1 ml	CapMat 381080, 381081		50 / 50
780261	U-bottom	○ natural	1 ml	CapMat 381070, 381061	+	1 / 50

Item no.	Well profile	Product colour	Total volume (well)	Lid	Sterile	Qty. inner / outer
780215	U-bottom	○ natural	1 ml	CapMat 381070, 381061		5 / 50
786201	V-bottom	○ natural	0.5 ml	CapMat 381070, 381061		8 / 80
786261	V-bottom	○ natural	0.5 ml	CapMat 381070, 381061	+	1 / 80
780270	V-bottom	○ natural	2 ml	CapMat 381080, 381081		1 / 50
780271	V-bottom	○ natural	2 ml	CapMat 381080, 381081	+	1 / 50
780285	V-bottom	○ natural	2 ml	CapMat 381080, 381081		5 / 50
780286	U-bottom	○ natural	1 ml	CapMat 381080, 381081	+	5 / 50



96 Well Storage Box

- / Storage box made of polycarbonate
- / With / without 96 polypropylene vessels
- / Coding card included
- / All components autoclavable

Item no.	Qty. inner / outer
975502	1 / 120

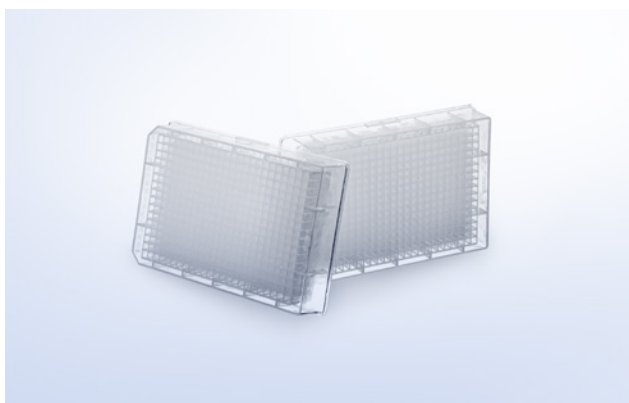

384 Deep Well MASTERBLOCK® Polypropylene

- / Ideal for compound libraries and applications with larger volumes
- / Conical well shape for precise pipetting
- / Alphanumeric well coding
- / Sealable with adhesive films and heat sealers



Well format: 384, Well profile: V-bottom, Bottom: solid, Raw material: PP, Plate geometry: Deep Well, Lid: no

Item no.	Product colour	Sterile	Qty. inner / outer
781270	○ natural		6 / 60

Item no.	Product colour	Sterile	Qty. inner / outer
781271	○ natural	+	6 / 60

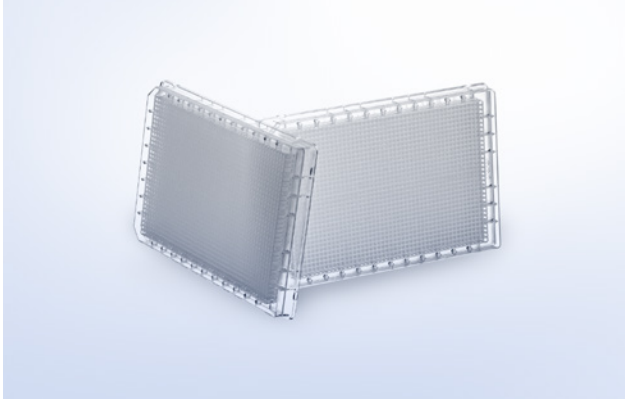

1536 Deep Well Microplates
Polypropylene

- / Uniform external dimensions and tolerances
- / Total volume of 18 μ l
- / Alphanumeric well coding
- / Sealable with adhesive films and heat sealers

FREE OF
detectable
DNase

FREE OF
detectable
human DNA

FREE OF
detectable
RNase

 non-
pyrogenic

Well format: 1536, Well profile: V-bottom, Bottom: solid, Raw material: PP, Plate geometry: Deep Well, Working volume: 3 μ l - 15 μ l, Lid: no

Item no.	Product colour	Sterile	Qty. inner / outer
782261	○ natural	+	15 / 60
782270	○ natural		15 / 60

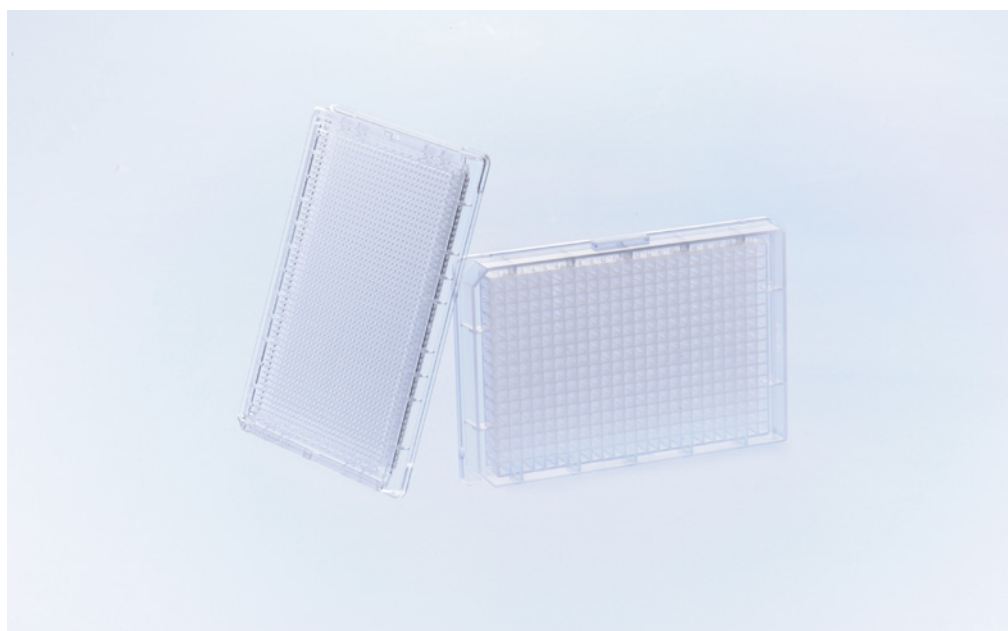

/ You can find more information about this product in our web-shop.



MICROPLATES FOR COMPOUND STORAGE

Polypropylene is still the material of choice for storage plates, but the material class of cycloolefins is becoming more routinely used because of its unsurpassed performance for a wide range of applications.

In compound storage, plates made from cycloolefins offer the

best combination of chemical resistance to polar solvents, like DMSO, and optical clarity. In addition, the dimensional stability and glass-like optical properties make this material ideally suited for plates in fully automated systems.

- / Suited for compound storage
- / Resistant against polar solvents
- / Excellent water and vapour barrier function
- / Almost no leachables
- / Low biomolecule binding
- / Glass-like optical properties

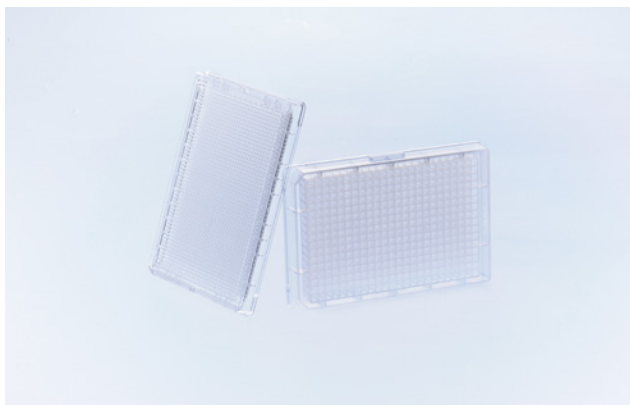

Microplates for Compound Storage

384 and 1536 Well

Microplates for Acoustic Liquid Handling

- / Stringent production specifications for a constant bottom quality
- / Microplates are deionised and packed in antistatic bags

Well profile: F-bottom, Bottom: solid, Lid: no

Item no.	Well format	Raw material	Surface treatment	Product colour	Plate geometry	Plate design	Working volume (well)	Sterile	Qty. inner / outer
781201-906	384	PP	untreated	○ natural			15 µl - 145 µl		10 / 100
793855	384	cycloolefin		○ clear	HiBase	Small Volume	1 µl - 25 µl		15 / 60
782855	1536	cycloolefin		○ clear	HiBase		1 µl - 10 µl		15 / 60
782865	1536	cycloolefin	TC	○ clear	HiBase		1 µl - 10 µl	+	15 / 60
792870-906	1536	cycloolefin		○ clear			1 µl - 14 µl		15 / 60



/ For more detailed information on well profiles and technical details please refer to our data sheets on our website: www.gbo.com

NON-BINDING MICROPLATES

Polystyrene microplates with non-treated surfaces are commonly used for homogeneous biochemical HTS assays and demonstrate low and reproducible biomolecule binding.

However, even low amounts of biomolecular binding (e. g. DNA, RNA, proteins, peptides) can cause an undesirable increase in background, resulting in decreased signal-to-noise ratio.

Greiner Bio-One's non-binding microplate surfaces prevent unwanted non-specific binding, especially advantageous for sensitive biochemical assays. Characterised by low protein, DNA, RNA and peptide binding properties the non-binding surfaces significantly increase assay sensitivity by reducing background and improving signal-to-noise ratio.

- / 96 / 384 / 1536 well format
- / Clear / black / white
- / Solid bottom or μ Clear® film bottom
- / Ultra low non-specific biomolecular binding properties
- / Long-term surface stability without degradation or leaching



FREE OF detectable DNase
FREE OF detectable human DNA
FREE OF detectable RNase
non-pyrogenic

Non-binding Microplates

96 Well

- / Clear / black / white
- / U-bottom, V-bottom or F-bottom/chimney well
- / Solid bottom or μ Clear® film bottom

Well format: 96, Raw material: PS, Binding characterisitc: Non-binding, Lid: no

Item no.	Well profile	Bottom	Product colour	Working volume (well)	Qty. inner / outer
650901	U-bottom	solid	○ clear	40 μ l - 280 μ l	10 / 40
651901	V-bottom	solid	○ clear	40 μ l - 200 μ l	10 / 40
655901	F-bottom / Chimney Well	solid	○ clear	25 μ l - 340 μ l	10 / 40
655904	F-bottom / Chimney Well	solid	○ white	25 μ l - 340 μ l	10 / 40
655900	F-bottom / Chimney Well	solid	● black	25 μ l - 340 μ l	10 / 40
655903	F-bottom / Chimney Well	μ Clear®	○ white	25 μ l - 340 μ l	10 / 40
655906	F-bottom / Chimney Well	μ Clear®	● black	25 μ l - 340 μ l	10 / 40

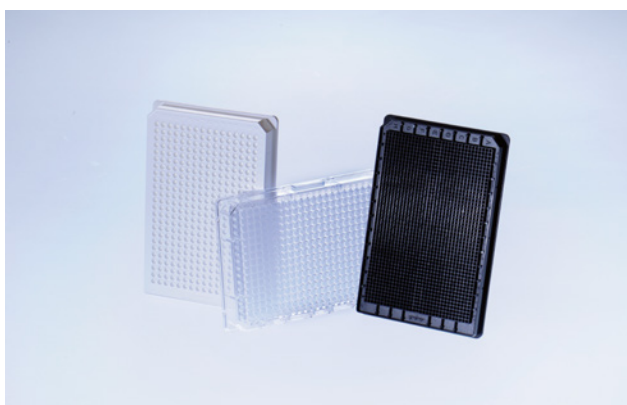

FREE OF detectable DNase
FREE OF detectable human DNA
FREE OF detectable RNase
non-pyrogenic

Non-binding Microplates

384 and 1536 Well

- / Clear / black / white
- / With F-bottom or as Small Volume option
- / Solid bottom or μ Clear® film bottom

Well profile: F-bottom, Raw material: PS, Binding characterisitc: Non-binding, Lid: no

Item no.	Well format	Bottom	Product colour	Plate geometry	Plate design	Working volume (well)	Qty. inner / outer
781901	384	solid	○ clear			15 μ l - 110 μ l	10 / 40
781904	384	solid	○ white			15 μ l - 110 μ l	10 / 40

HTS-Microplates

Non-binding Microplates

Item no.	Well format	Bottom	Product colour	Plate geometry	Plate design	Working volume (well)	Qty. inner / outer
781900	384	solid	● black			15 µl - 110 µl	10 / 40
781903	384	µClear®	○ white			15 µl - 110 µl	10 / 40
781906	384	µClear®	● black			15 µl - 110 µl	10 / 40
784904	384	solid	○ white	HiBase	Small Volume	4 µl - 25 µl	10 / 40
784900	384	solid	● black	HiBase	Small Volume	4 µl - 25 µl	10 / 40
782904	1536	solid	○ white	HiBase		3 µl - 10 µl	15 / 60
782900	1536	solid	● black	HiBase		3 µl - 10 µl	15 / 60



- / For more detailed information on well profiles and technical details please refer to our data sheets on our website: www.gbo.com

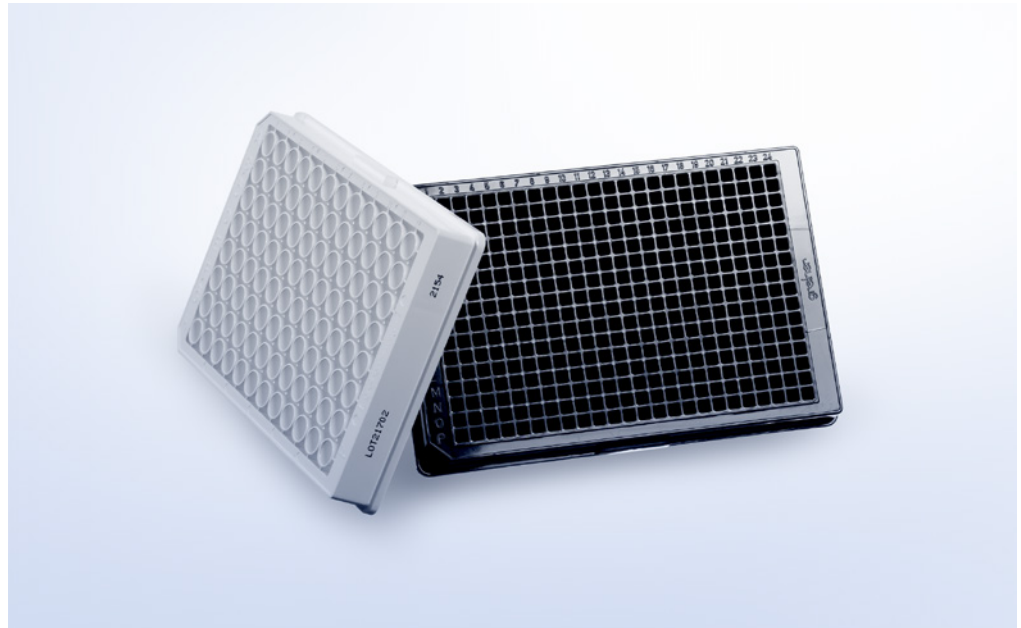

STREPTAVIDIN-COATED MICROPLATES

Streptavidin-coated solid phases serve as reliable binding surfaces for all types of biotinylated molecules.

Numerous ligands can be biotinylated simply and due to the low molecular weight of biotin (244 Da) the functionality of the molecules is normally not impaired. Thus streptavidin-coated solid phases make it possible to rapidly isolate, determine and quantify components from a reaction mixture. By immobilising the bi-

otinylated substance, it is also possible to reproduce complete reaction chains on a streptavidin solid phase, e. g. enzyme immunoassays, enzyme activity assays, DNA hybridisation techniques and quantification of PCR products.

The high-purity streptavidin is bound to the plate surface in a uniform and stable layer. The coefficient of variation from well to well is under 5 % for 96 well microplates and under 8 % for 384 well microplates.

- / Available in 96 well and 384 well format
- / Clear / black / white
- / 3-year shelf life at room temperature
- / All plates pre-blocked and ready-to-use

HTS-Microplates

Streptavidin-coated Microplates

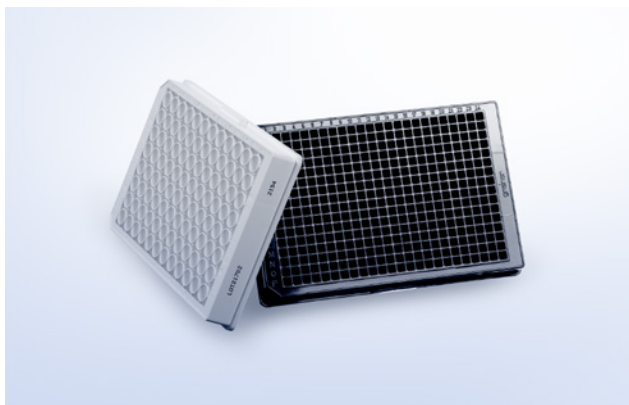

Streptavidin-coated Microplates 96 and 384 Well

- / Long shelf life at room temperature
- / Lot number on each pack
- / Pre-blocked with BSA

Raw material: PS, Surface treatment: Streptavidin, Lid: no

Item no.	Well format	Well profile	Bottom	Product colour	Qty. inner / outer
655990	96	C-bottom	solid	○ clear	5 / 40
655994	96	F-bottom	solid	○ white	5 / 40
655997	96	C-bottom	solid	● black	5 / 40
781990	384	F-bottom	solid	○ clear	5 / 40
781995	384	F-bottom	solid	○ white	5 / 40
781997	384	F-bottom	solid	● black	5 / 40
781996	384	F-bottom	µClear®	● black	5 / 40

/ Further streptavidin-coated microplates are available on request.



/ Application Note: UV/
VIS Spectroscopy in
Microplates UV-Star®,
µClear®, MICROLON and
CELLSTAR®

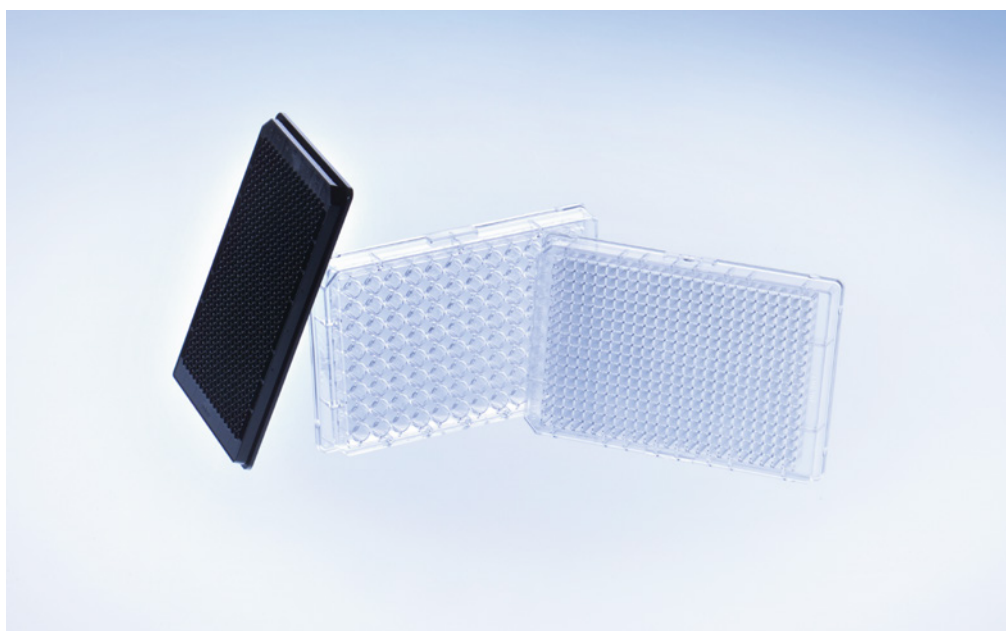

UV-STAR® MICROPLATES

UV / VIS spectroscopy is a classical analytical method for determining the chemical constitution of a substance and its concentration in aqueous solution.

UV / VIS spectroscopy is usually conducted in quartz glass cuvettes. However, cuvettes do not provide sufficient throughput when dealing with large amounts of samples, and microplates can be used to speed up work.

Standard polystyrene microplates are only partially suitable for transmission measurements in the UV. Polystyrene absorbs UV especially in the short-wavelength range (< 320 nm). µClear® microplates with a thin polystyrene film base al-

ready have much lower background values and can be used up to 340 nm without any problem. The adaptation of the patented µClear® process technology to a new, innovative UV-transparent material has made it possible to produce microplates that extend the transmission range up to 230 nm.

For the determination of nucleic acid and protein concentrations at 260 nm or 280 nm without background interference UV-Star® microplates are the ideal alternative to expensive and fragile quartz glass plates or cuvettes. UV-Star® plates are also DMSO-resistant and can be stored at -20 °C without any problem.

- / Available in 96 well and 384 well format
- / With cycloolefin film bottom
- / Optical window down to 230 nm ideal for nucleic acid determinations at 260 nm/280 nm
- / For measurements of protein concentration at 280 nm

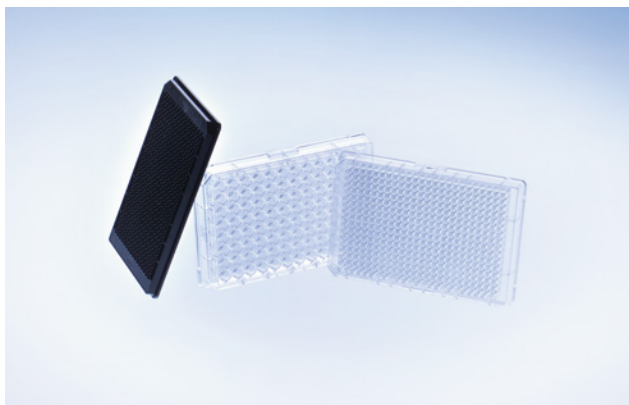

FREE OF
detectable
DNase

FREE OF
detectable
human DNA

FREE OF
detectable
RNase

 non-
pyrogenic

UV-Star® Microplates

- / Available in 96 well and 384 well format
- / With cycloolefin film bottom
- / Optical window down to 230 nm ideal for nucleic acid determinations at 260 nm/280 nm
- / For measurements of protein concentration at 280 nm

Bottom: Cycloolefin film, Raw material: COC, Surface treatment: untreated, Lid: no

Item no.	Well format	Well profile	Product colour	Plate geometry	Plate design	Working volume (well)	Qty. inner / outer
655801	96	F-bottom / Chimney Well	○ clear			25 µl - 340 µl	10 / 40
675801	96	F-bottom	○ clear		half area	15 µl - 175 µl	10 / 40
781801	384	F-bottom	○ clear			15 µl - 110 µl	10 / 40
655809	96	F-bottom / Chimney Well	● black			25 µl - 340 µl	10 / 40
788876	384	F-bottom	● black	LoBase	Small Volume	4 µl - 25 µl	10 / 80



- / Forum No 6: Sealers for microplates and their areas of application in molecular biology and cell culture (F073013)

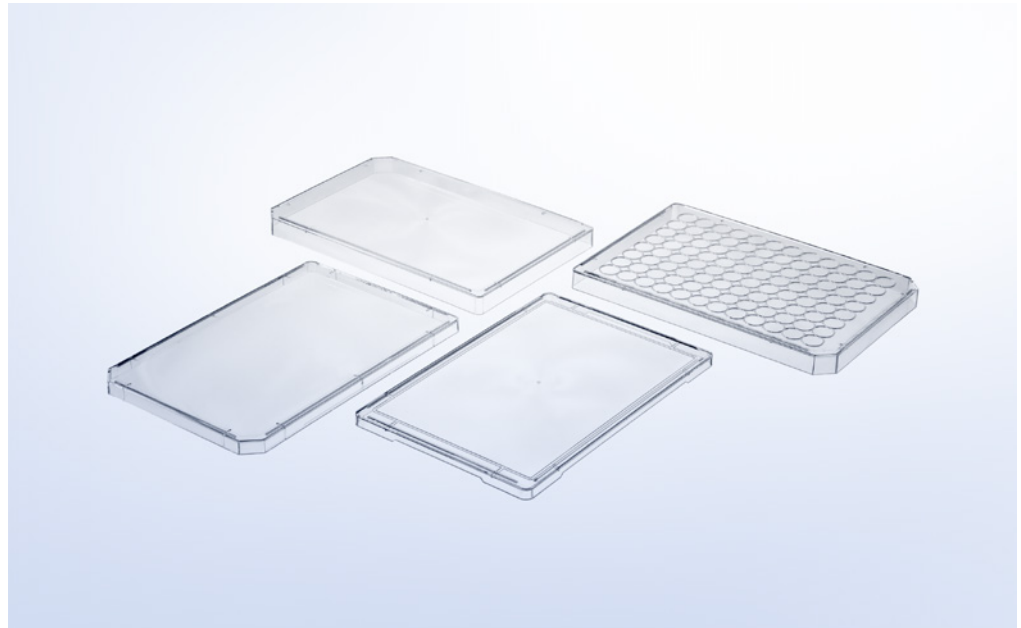

LIDS / SEALERS / CAPMATS

- / Polystyrene lids in three different profile heights with and without condensation rings
- / Classical adhesive films coated with acrylate adhesive as well as advanced adhesive films with pressure-sensitive silicone adhesive
- / EVA CapMats for sealing of 96 well plates

Lids offer protection against contamination and evaporation during sample storage and cell cultivation.

In addition, Greiner Bio-One offers a full set of adhesive sealers for a wide range of routine and specialised applications, e.g. high-throughput screen-

ing, immunology, microbiology, molecular biology and PCR.

An alternative method for sealing 96 well plates are CapMats. They are made of ethyl vinyl acetate (EVA), are resistant to DMSO and can be used in a temperature range between -20 °C and +60 °C. CapMats are not pierceable.

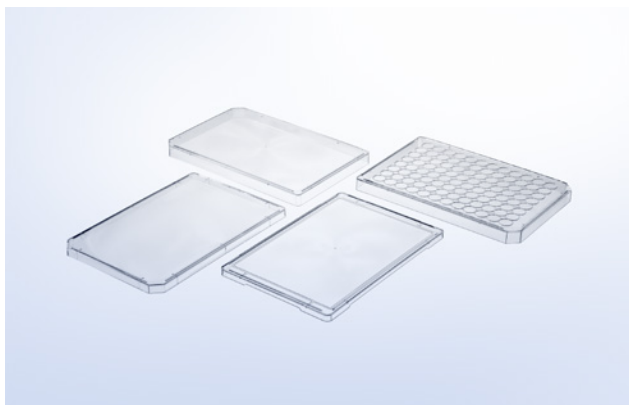

Lids

All sterile lids are non-cytotoxic.

Description: Lid

Item no.	Height	Raw material	Product colour	Condensation rings	Lid type	Sterile	Qty. inner / outer
656101	9 mm	PS	○ clear	no	high		1 / 100
656161	9 mm	PS	○ clear	no	high	+	1 / 100
656170	9 mm	PS	○ clear	yes	high		1 / 100
656171	9 mm	PS	○ clear	yes	high	+	1 / 100
656190	6 mm	PS	○ clear	no	flat		20 / 200
656191	6 mm	PS	○ clear	no	flat	+	20 / 200
691101	4.8 mm	PS	○ clear	no	ultra low		25 / 100
691161	4.8 mm	PS	○ clear	no	ultra low	+	25 / 100
656176	9 mm	PS	○ clear	yes	high	+	10 / 150
656197	9 mm	PS	○ clear	no	high		- / 150
656199	6 mm	PS	● black	no	flat		50 / 400
792891	4.3 mm	COC	○ clear	no	ultra low		30 / 120

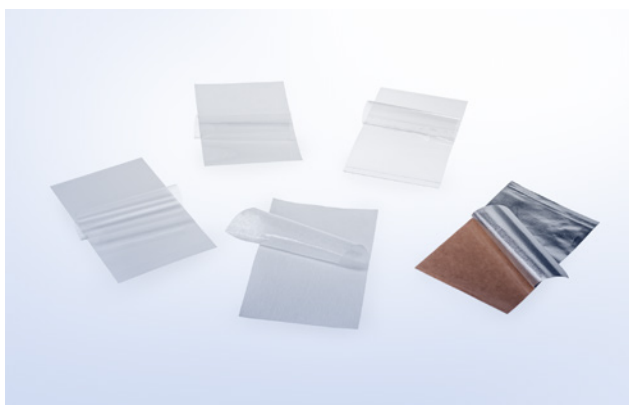

Sealers

The classical sealers such as EASYseal, AMPLIseal, SILVERseal and BREATHseal are coated with an acrylate adhesive. The advanced sealer VIEWseal is coated with a pressure-sensitive silicone adhesive.

Item no.	Description	Feature	Pierceable	Sterile	Qty. inner / outer
676001	EASYseal	clear			100 / 2,000
676090	SILVERseal	aluminium foil	yes		100 / 1,200
676070	VIEWseal	clear			100 / 1,200

Item no.	Description	Feature	Pierceable	Sterile	Qty. inner / outer
676040	AMPLIseal	clear			100 / 2,000
676050	BREATHseal	Gas-permeable			50 / 2,500
676051	BREATHseal	Gas-permeable		+	50 / 500

/ Forum No. 6: Sealers for microplates and their areas of application in molecular biology and cell culture (F073013)

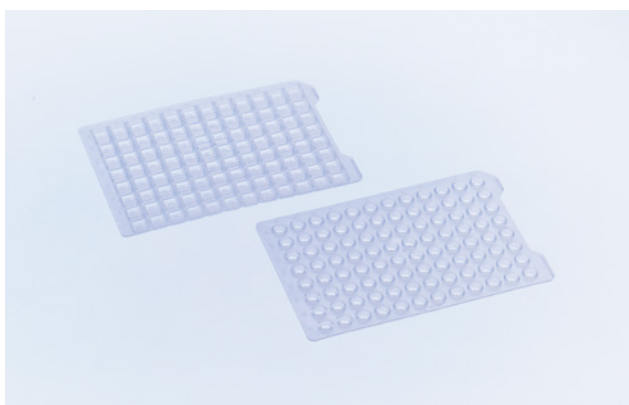

CapMats

- / Made of ethyl vinyl acetate (EVA)
- / Available for 96 well microplates and MASTER-BLOCK®
- / Sterile / non-sterile

FREE OF
detectable
DNase

FREE OF
detectable
human DNA

FREE OF
detectable
RNase

 non-
pyrogenic

Description: 96 Well CapMat, Pierceable: no, Raw material: EVA

Item no.	Nap shape	Sterile	Qty. inner / outer
381070	round		10 / 50
381061	round	+	1 / 50
381080	square		10 / 50
381081	square	+	1 / 50

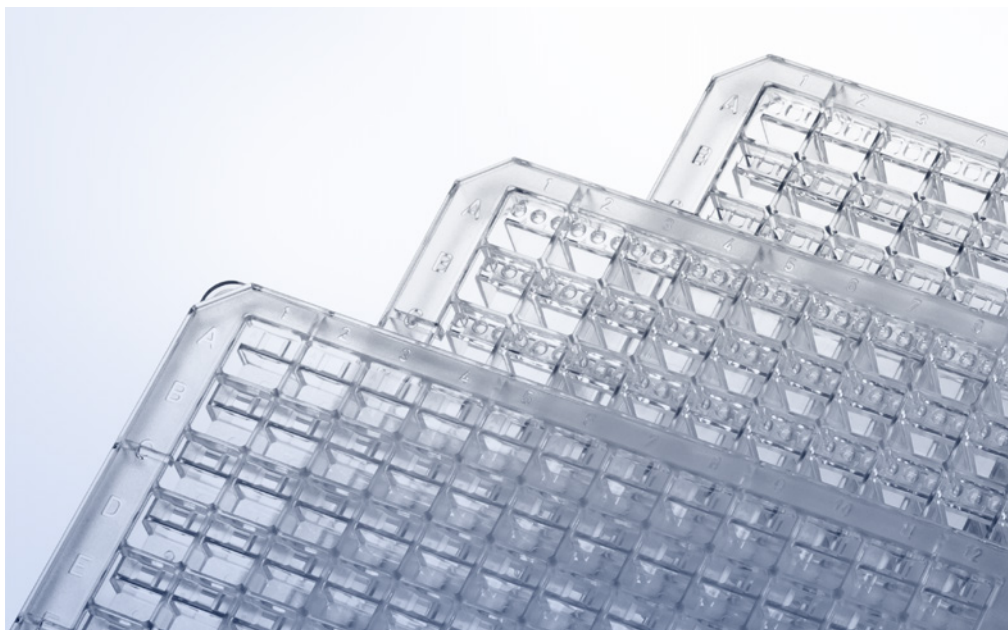

/ Forum No. 7: Advanced high-throughput platforms for protein crystallisation (F073016)

PROTEIN CRYSTALLISATION PLATES

Detailed knowledge of interactions between the structure and function of biomolecules is fundamental for biological, medical and pharmaceutical research. A reliable method is the X-ray structure analysis of protein crystals.

In order to show three-dimensional molecular structures, the proteins must first be crystallised. Since every protein is different and a variety of factors influence protein crystallisation, the optimal conditions are usually tested with high-throughput technologies (pipetting robots).

Greiner Bio-One has specially developed microplates and accessories of the CrystalStar series to meet the requirements of high-throughput crystallisation in a short time and with relatively small amounts of protein. Techniques such as vapour diffusion (sitting drop, hanging drop) and microbatch under oil can be carried out effectively.

Plates with **hydrophobic** surface are particularly well suited for nanolitre crystallisation of membrane proteins. **LBR (low birefringence)** plates are specifically designed for the use of polarised light.

- / For vapour diffusion or microbatch under oil
- / Made of polystyrene or polyolefin (LBR plates)
- / Footprint conforming to ANSI 1-2004 (except Terasaki plates)
- / Barcode labelling on request
- / CrystalQuick plates with alphanumeric well coding

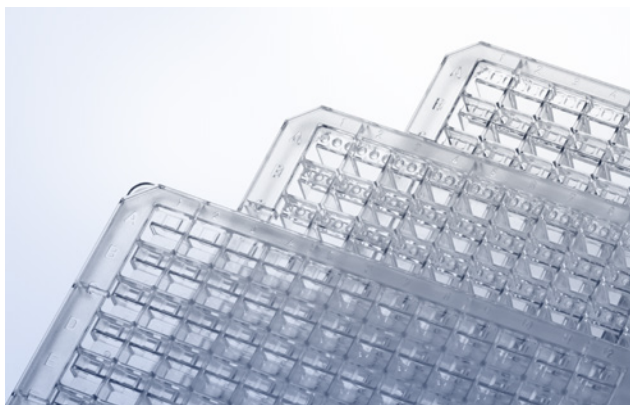

**96 Well CrystalQuick /
CrystalQuick Plus Plates**

- / Crystallisation plates for sitting drop applications with different well profiles and material properties
- / Optimised for sealing with VIEWseal or AMPLIseal
- / Alphanumeric well coding

Well format: 96

Item no.	Height	Material properties	Well profile	Plate design	Well / reservoir	Well volume, max	Volume per reservoir	Qty. inner / outer
609171	8 mm	standard	flat	square (LP)	1	3.9 µl	140 µl	20 / 80
609180	8 mm	hydrophobic	flat	square (LP)	1	3.9 µl	140 µl	20 / 80
609871	8 mm	LBR	flat	square (LP)	1	3.9 µl	140 µl	20 / 80
609101	14.4 mm	standard	flat	square (SW)	3	4.1 µl	320 µl	10 / 40
609120	14.4 mm	standard	concave	round (RW)	3	1.9 µl	320 µl	10 / 40
609130	14.4 mm	hydrophobic	flat	square (SW)	3	4.1 µl	320 µl	10 / 40
609801	14.4 mm	LBR	flat	square (SW)	3	4.1 µl	320 µl	10 / 40
609820	14.4 mm	LBR	concave	round (RW)	3	1.9 µl	320 µl	10 / 40
609830	14.4 mm	LBR, hydrophobic	flat	square (SW)	3	4.1 µl	320 µl	10 / 40



**24 Well ComboPlate
CrystalBridge / Coverslips**

- / Universal 24 well crystallisation plate with coverslips and CrystalBridge for sitting drop applications
- / Siliconised coverslips available

Item no.	Description	Feature	Well format	Ø well	Bottom shape	Well volume, max	Lid	Qty. inner / outer
662050	ComboPlate	pre-greased	24	16.3 mm	flat	3,300 µl	yes	- / 24
662150	ComboPlate		24	16.3 mm	flat	3,300 µl	yes	6 / 24
662145	CrystalBridge		1	4.6 mm	concave	45 µl	no	- / 250
501870	round coverslips 18 mm	siliconised glass 0.19 - 0,22 mm						100 / 1,000
503870	round coverslips 22 mm	siliconised glass 0.19 - 0,22 mm						100 / 1,000
503850	round coverslips 22 mm	siliconised glass 0.5 - 0,6 mm						100 / 1,000

/ Siliconised coverslips for Linbro plates (round, Ø 22 mm) are available on request.



The ELISA technique (Enzyme-Linked Immunosorbent Assay) is one of the most widely used biochemical methods in analytical laboratories and in diagnostics. With this method, analytes such as peptides, proteins, antibodies and hormones are detected and quantified selectively and in low concentrations. In addition, ELISAs can be automated and carried out with a high sample throughput, are relatively inexpensive and the test results are available promptly.

IMMUNOLOGY / HLA

/ ELISA Microplates	144
96 Well ELISA Microplates U-Bottom / V-Bottom / F-Bottom / Half Area.....	145
/ ELISA Strip Plates	146
96 Well ELISA Strip Plates	147
Single-break Strip Plates	148
/ Immuno Tubes	149
Immuno Tubes	150
/ Terasaki Plates	151
Terasaki Plates	152

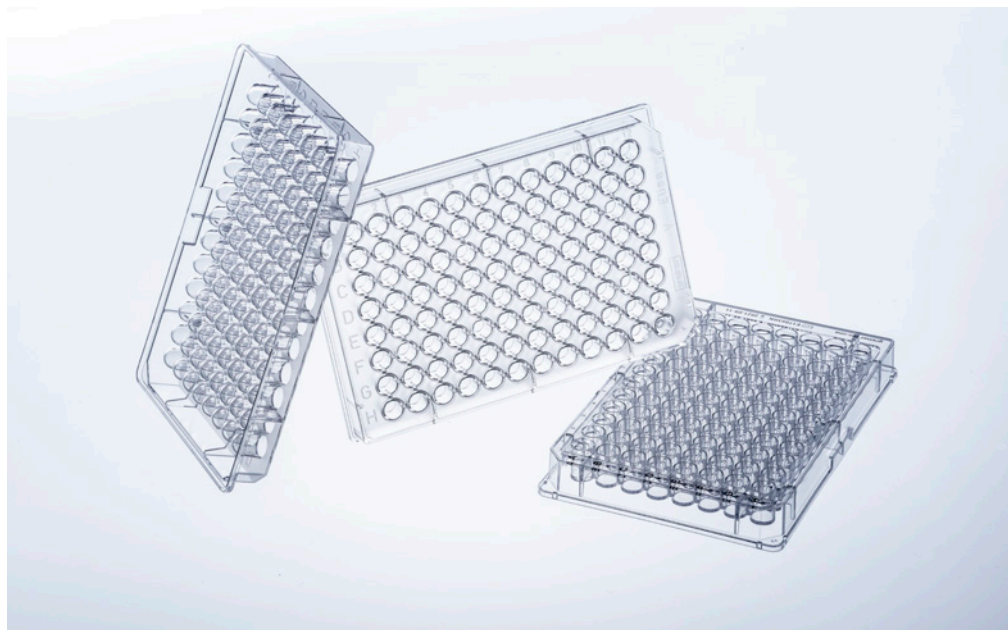

/ Watch our video:



ELISA MICROPLATES

Greiner Bio-One has been manufacturing microplates for diagnostics and immunological research for over 30 years.

The microplate footprint is compatible with automated systems. A key step in ELISA is the binding of one assay component – antigen or antibody – to the solid surface by passive adsorption. Therefore, the features of this surface are crucial for the performance of the assay. All ELISA microplates from Greiner Bio-One are made out of

high-quality virgin polystyrene. The resin is highly transparent and therefore ideally suited for optical measurements.

Beside products made of clear polystyrene for colorimetric measurements, Greiner Bio-One offers a wide variety of black and white ELISA microplates for luminescence and fluorescence measurements.

The quality of our immunological products is constantly controlled in our quality assurance laboratory by means of ELISA.

- / With U-Bottom / V-Bottom / F-Bottom standard (ST) / F-bottom chimney well / half area well geometry
- / With medium and high-binding surfaces
- / Made of clear / black / white polystyrene for transmission, fluorescence or luminescence measurements

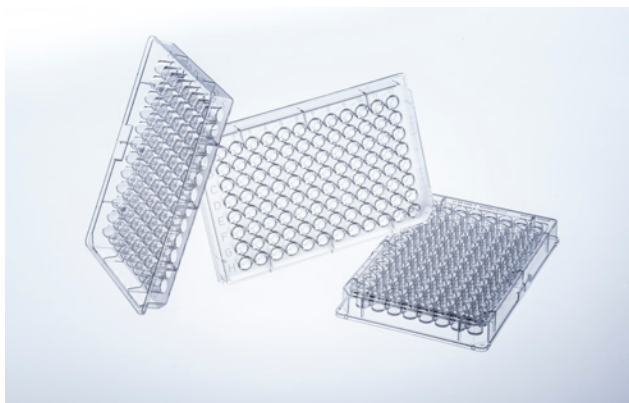

96 Well ELISA Microplates
U-Bottom / V-Bottom / F-Bottom / Half

/ Manufactured from crystal clear polystyrene

Well format: 96, Raw material: PS, Lid: no

Item no.	Well profile	Bottom	Binding characterisitic	Binding brand name	Product colour	Plate design	Working volume (well)	Qty. inner / outer
650001	U-bottom	solid	med.-binding	MICROLON 200	○ clear		40 µl - 280 µl	10 / 40
650061	U-bottom	solid	high-binding	MICROLON 600	○ clear		40 µl - 280 µl	10 / 40
650061	U-bottom	solid	high-binding	MICROLON 600	○ clear		40 µl - 280 µl	10 / 40
651001	V-bottom	solid	med.-binding	MICROLON 200	○ clear		40 µl - 200 µl	10 / 40
651061	V-bottom	solid	high-binding	MICROLON 600	○ clear		40 µl - 200 µl	10 / 40
655001	F-bottom/ ST	solid	med.-binding	MICROLON 200	○ clear		25 µl - 340 µl	10 / 40
655061	F-bottom/ ST	solid	high-binding	MICROLON 600	○ clear		25 µl - 340 µl	10 / 40
655080	F-bottom / Chimney Well	solid	med.-binding	MICROLON 200	○ clear		25 µl - 340 µl	10 / 40
655081	F-bottom / Chimney Well	solid	high-binding	MICROLON 600	○ clear		25 µl - 340 µl	10 / 40
675001	F-bottom	solid	med.-binding	MICROLON 200	○ clear	half area	15 µl - 175 µl	10 / 40
675061	F-bottom	solid	high-binding	MICROLON 600	○ clear	half area	15 µl - 175 µl	10 / 40
655000	U-bottom / Chimney Well	without bottom			○ clear			10 / 40
655000-06		without bottom			○ clear			10 / 40

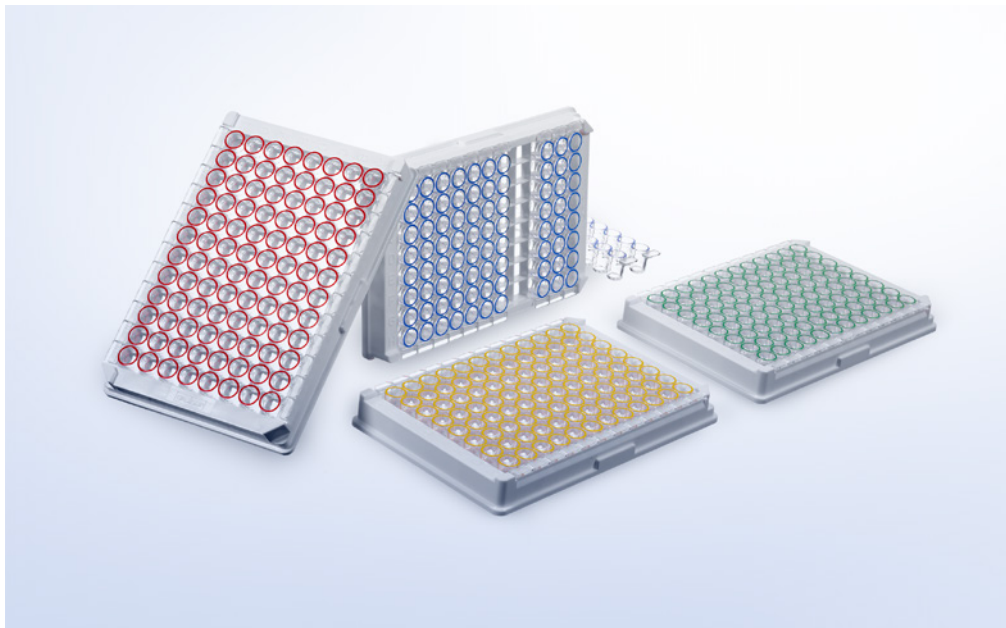

/ Watch our video:



ELISA STRIP PLATES

Greiner Bio-One is offering a large variety of 96 well strip microplates for diagnostic and immunological research applications.

Microplates in strip format offer the advantage of greater flexibility in diagnostics. Individual strips can be removed from the support frame so that the number of tests to be performed can be adjusted to the number of samples and is not predetermined by the microplate format used. In addition, the individual strips can be subjected to a wide variety of different test conditions. The quality of our immunological products is constantly

controlled in our quality assurance laboratory by means of ELISA. Clear MICROLON products are tested in a colorimetric immunoassay, black FLUOTRAC plates in a fluorescence immunoassay, white LUMITRAC plates in a luminescence immunoassay. The portfolio is completed by C8 single-break strip plates for immunological applications. These are supplied as twelve 8-well strips in a support frame with 96 spaces (12 x 8 matrix). The individual wells can be broken off separately ("single-break" option) and the number of tests performed can thus be precisely adjusted to the number of samples.

96 Well ELISA Strip Plates

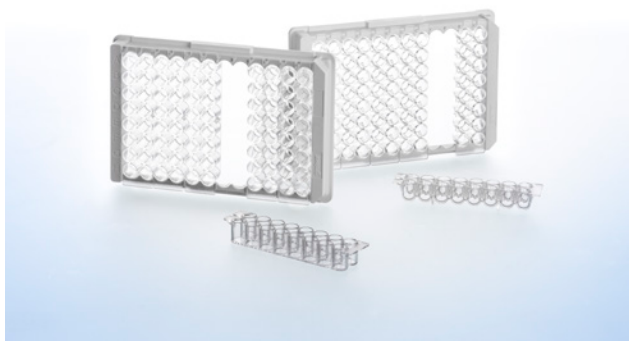

- / Strips mounted in frame
- / Black and white F16 and U16 strip plates on request

Well format: 96, Bottom: solid, Raw material: PS, Lid: no

Item no.	Well profile	Binding characterisitic	Binding brand name	Product colour	Plate design	Working volume (well)	Qty. inner / outer
701070	F-bottom	med.-binding	MICROLON 200	○ clear	strip plate 8x12	50 µl - 280 µl	10 / 100
701071	F-bottom	high-binding	MICROLON 600	○ clear	strip plate 8x12	50 µl - 280 µl	10 / 100
767070	U-bottom	med.-binding	MICROLON 200	○ clear	strip plate 12x8	50 µl - 280 µl	10 / 100
756001	F-bottom	med.-binding	MICROLON 200	○ clear	strip plate 6x18		- / 300
762001	F-bottom	med.-binding	MICROLON 200	○ clear	strip plate 12x8		100 / 400
762061	F-bottom	high-binding	MICROLON 600	○ clear	strip plate 12x8		100 / 400
767001	U-bottom	med.-binding	MICROLON 200	○ clear	strip plate 12x8	50 µl - 280 µl	- / 400
767071	U-bottom	high-binding	MICROLON 600	○ clear	strip plate 12x8	50 µl - 280 µl	10 / 100
762070	F-bottom	med.-binding	MICROLON 200	○ clear	strip plate 12x8	20 µl - 350 µl	10 / 100
762071	F-bottom	high-binding	MICROLON 600	○ clear	strip plate 12x8	20 µl - 350 µl	10 / 100
762075	F-bottom	med.-binding	LUMITRAC 200	○ white	strip plate 12x8	20 µl - 350 µl	10 / 100
762074	F-bottom	high-binding	LUMITRAC 600	○ white	strip plate 12x8	20 µl - 350 µl	10 / 100
762076	F-bottom	med.-binding	FLUOTRAC 200	● black	strip plate 12x8	20 µl - 350 µl	10 / 100
762077	F-bottom	high-binding	FLUOTRAC 600	● black	strip plate 12x8	20 µl - 350 µl	10 / 100
756070	F-bottom	med.-binding	MICROLON 200	○ clear	strip plate 6x18	20 µl - 350 µl	10 / 100
756071	F-bottom	high-binding	MICROLON 600	○ clear	strip plate 6x18	20 µl - 350 µl	10 / 100
754070	U-bottom	med.-binding	MICROLON 200	○ clear	strip plate 6x18	50 µl - 280 µl	10 / 100
754061	U-bottom	high-binding	MICROLON 600	○ clear	strip plate 6x18	50 µl - 280 µl	10 / 100

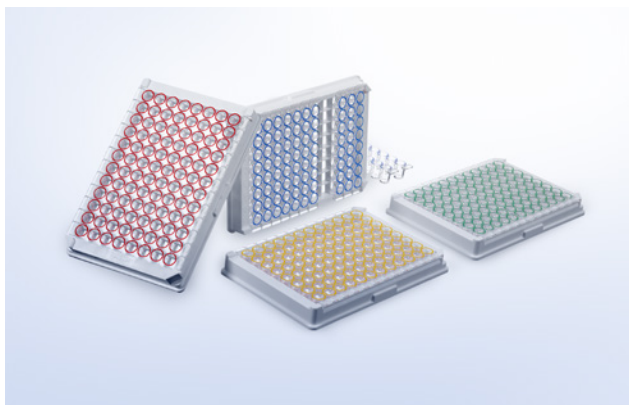

Single-break Strip Plates

- / Clear with / without colour coding
- / Strips mounted in frame
- / C8 Single-break strip plates without colour coding cell culture treated on request

FREE OF detectable DNase	FREE OF detectable human DNA	FREE OF detectable RNase	 non-pyrogenic
--------------------------	------------------------------	--------------------------	---

Well format: 96, Well profile: C-bottom, Raw material: PS, Plate design: strip plate 12x8, Working volume (well): 20 µl - 300 µl, Lid: no

Item no.	Bottom	Binding characterisitc	Binding brand name	Colour stripe	Colour coding well rim	Qty. inner / outer
705070	solid	med.-binding	MICROLON 200	○ clear		10 / 100
705071	solid	high-binding	MICROLON 600	○ clear		10 / 100
705063	solid	med.-binding	MICROLON 200	○ clear	● red	10 / 100
705073	solid	high-binding	MICROLON 600	○ clear	● red	10 / 100
705074	solid	high-binding	MICROLON 600	○ clear	● blue	10 / 100
705065	solid	med.-binding	MICROLON 200	○ clear	● green	10 / 100
705075	solid	high-binding	MICROLON 600	○ clear	● green	10 / 100
705066	solid	med.-binding	MICROLON 200	○ clear	● yellow	10 / 100
705076	solid	high-binding	MICROLON 600	○ clear	● yellow	10 / 100
705092		high-binding	LUMITRAC 600	○ white		10 / 100



/ More tubes can be found in the chapter Tubes / Multipurpose containers

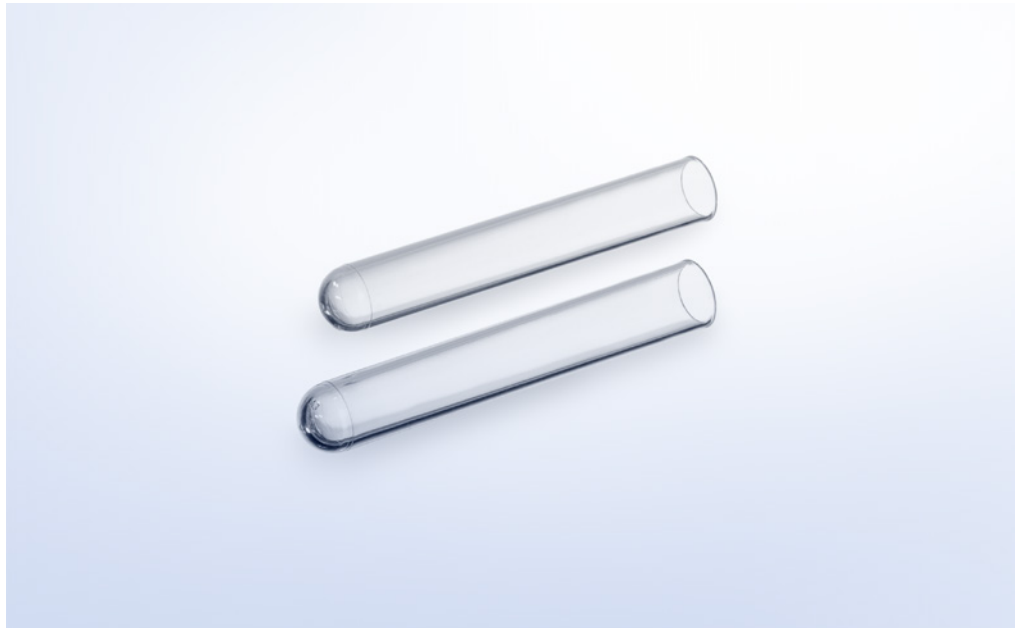

IMMUNO TUBES

Immuno tubes are often used for determining hormone levels, for example TSH (thyroid stimulating hormone). With a length of 75 mm and a diameter of 12 mm with and without a “star”, they are available in both MICROLON 200 and MICROLON 600 quality. The so-called “star” at the bottom of

the tubes serves to increase the surface and thus makes it possible to bind larger amounts of antigens or antibodies.

The quality of our immunological products is constantly controlled in our quality assurance laboratory by means of ELISA.

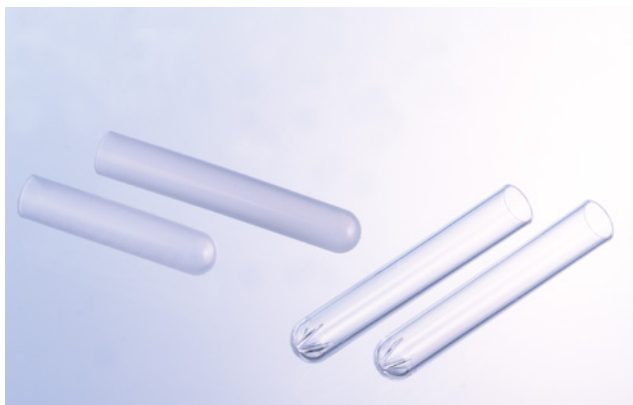

Immuno Tubes

/ More tubes can be found in the chapter Tubes / Multipurpose containers

Height: 75 mm, Ø: 12 mm, Raw material: PS, Nominal volume: 5 ml

Item no.	Binding characterisitc	Binding brand name	Bottom shape	Qty. inner / outer
115001	med.-binding	MICROLON 200	round	250 / 2.000
115061	high-binding	MICROLON 600	round	250 / 2.000
115070	med.-binding	MICROLON 200	round with star	250 / 2.000
115071	high-binding	MICROLON 600	round with star	250 / 2.000



/ We provide Terasaki plates with one years' stability on the surface treatment.



TERASAKI PLATES

Greiner Bio-One Terasaki plates are suitable for all applications for serological determination of HLA antigens. The plates are supplied either with 60 or 72 wells, the plate dimensions stay the same.

The human leucocyte antigen (HLA) system is the major histocompatibility complex (MHC) of humans and is composed of the two polymorphic classes HLA-I (A, B, and C) and HLA-II (DR, DQ, and DP). Basically, four different areas of indication can be distinguished for HLA typing: transplantation, transfusion, disease association and

forensic.

The serological determination of HLA proteins of the HLA-A, -B, -C and -DR genetic positions is primarily performed with the complement-dependent microlymphocytotoxicity test (LCT) or Terasaki test, which has been standardised since 1964. The basis for this test method is the cytolysis of the lymphocytes to be tested, which is caused by the antibody-antigen mediated activation of the complement system. Permeabilised lymphocytes are generally stained with chromophores or fluorophores and evaluated microscopically.

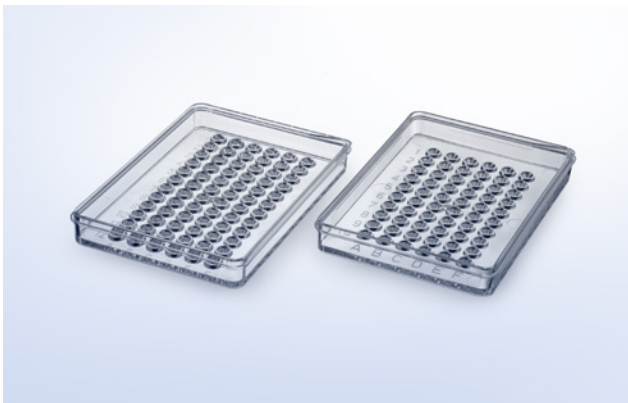

Terasaki Plates

- / 60 well and 72 well Terasaki plates
- / Manufactured from crystal clear polystyrene
- / Item 659180 contains one lid per bag



Surface treatment: TC, Well volume, max: 11.5 µl, Working volume (well): ≤10 µl, Lid: yes

Item no.	Well format	Stackable	Qty. inner / outer
653180	60	no	10 / 270
653190	60	no	120 / 480
659180	60	yes	10 / 200
659190	60	yes	150 / 1.200
654180	72	no	10 / 270
769190	72	yes	150 / 1.200



The study of microorganisms, their metabolism and their effects on other (macro-) organisms generally refers to the field of microbiology. The various detection methods are used in many research areas and in industry. For example, tests for the detection of microorganisms and for quality assurance are also applied in the production of pharmaceuticals, cosmetics, food and beverages.

MICROBIOLOGY

/ Dishes / Plates / Others	156
Petri Dishes	157
Contact Dishes Divided Petri Dish.....	158
Macroplate / Square Petri Dish / OneWell Plate.....	158
Disposable Inoculation Loops / Needles	159
Spreaders	159
Disposal Bags	160

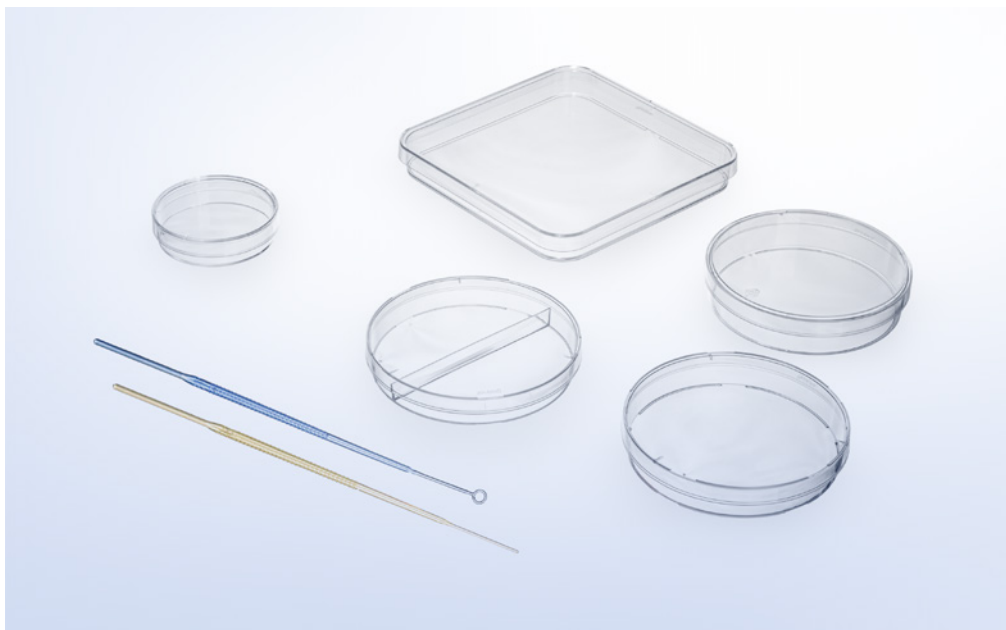

/ For exact dimensions of our petri dishes, please refer to the product data sheets on our website.

DISHES / PLATES / OTHERS

Greiner Bio-One offers petri dishes with diameters of 35, 60, 94, 100 and 145 mm. Manufactured from highly transparent polystyrene (PS), they are heat-resistant up to 60 °C for use with hot agar. Depending on the application vented and non-vented design can be selected. Besides the standard round design, a square-profile dish (120 mm x 120 mm x 17 mm) and the OneWell Plate in SBS format are available.

Furthermore, Greiner Bio-One offers contact dishes which are used with hygiene monitoring including detection of contaminations as well as testing the effectiveness of cleaning and disinfection on plane surfaces by means of contact cultures. The product range is completed by a special model with two compartments which enables parallel experiments with different samples or parameters in one dish.



Petri Dishes

- / Available in different sizes
- / Easy stacking
- / With or without vents
- / Manufactured from crystal clear polystyrene

Item no.	Height	Ø nominal size	Vent nock	Sterile	Qty. inner / outer
627102	10 mm	35 mm	yes		10 / 740
632102	16 mm	94 mm	no		20 / 480
639161	20 mm	145 mm	yes	+	15 / 120
627161	10 mm	35 mm	yes	+	10 / 740
628102	15 mm	60 mm	yes		20 / 600
628161	15 mm	60 mm	yes	+	20 / 600
632180	16 mm	94 mm	no		20 / 480
633180	16 mm	94 mm	yes		20 / 480
633181	16 mm	94 mm	yes	+	20 / 480
632161	16 mm	94 mm	no	+	20 / 480
632181	16 mm	94 mm	no	+	20 / 480
664102	20 mm	100 mm	yes		15 / 360
664161	20 mm	100 mm	yes	+	15 / 360
639102	20 mm	145 mm	yes		15 / 120



Contact Dishes

Divided Petri Dish

- / With or without vents
- / Manufactured from crystal clear polystyrene
- / Contact dish (sterile) with graduation to enable quick and easy analyses

Height: 15 mm

Item no.	Feature	Compartments	Ø nominal size	Total volume (well)	Vent nock	Sterile	Qty. inner / outer
629161	graduated		65 mm		no	+	20 / 600
629180	graduated		65 mm		yes	+	20 / 600
635102	2 compartments	2	94 mm	20 ml	yes		20 / 480
635161	2 compartments	2	94 mm		yes	+	20 / 480



Macroplate / Square Petri Dish /

OneWell Plate

- / With vents
- / Manufactured from crystal clear polystyrene
- / Optimised space requirement compared to round dishes

Item no.	Feature	Well format	Length	Width	Raw material	Product colour	Total volume (well)	Lid	Vent nock	Sterile	Qty. inner / outer
657102	microplate format	6	127.8 mm	85.5 mm	PS	○ clear	16 ml	yes, condensation rings			2 / 100
688102	square		120 mm	120 mm		○ clear		yes	yes		10 / 240
670102	microplate format	1	127.8 mm	85.5 mm		○ clear	113.7 ml	yes	yes		8 / 32
688161	square		120 mm	120 mm		○ clear		yes	yes	+	10 / 240

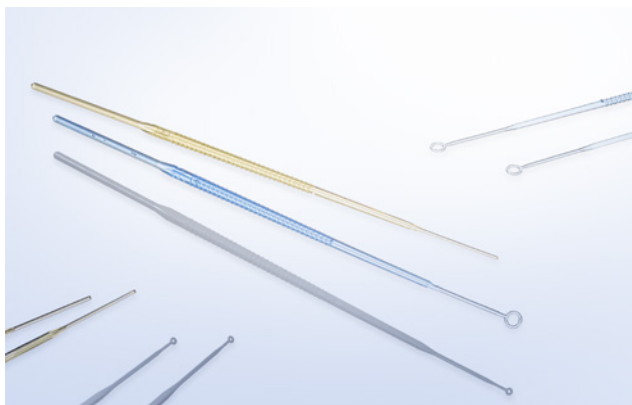

STERILE

Disposable Inoculation Loops / Needles

- / Needles ideal for picking single colonies
- / Flexible loops for easier collection and inoculation
- / Colour coding for volume differentiation

Length: 200 mm, Sterile: +

Item no.	Description	Product colour	Volume	Sterile	Qty. inner / outer
731101	inoculation loop	○ white	1 µl	+	50 / 2,000
731161	inoculation loop	○ white	1 µl	+	1 / 600
731165	inoculation loop	○ white	1 µl	+	10 / 3,000
731170	inoculation loop	● blue	10 µl	+	50 / 2,000
731171	inoculation loop	● blue	10 µl	+	1 / 600
731175	inoculation loop	● blue	10 µl	+	10 / 3,000
731180	inoculation needle	● yellow		+	50 / 2,000
731181	inoculation needle	● yellow		+	1 / 600
731185	inoculation needle	● yellow		+	1 / 3,000

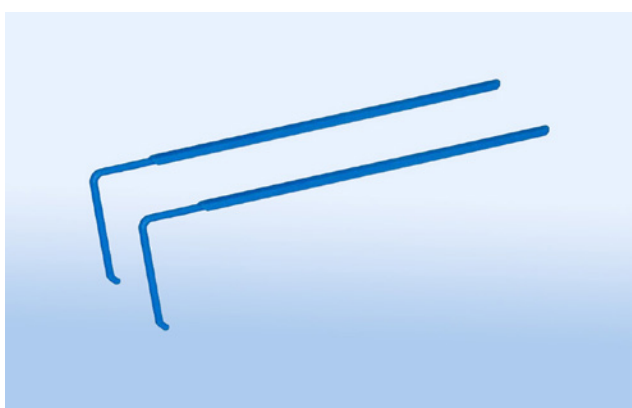

STERILE

Spreaders

- / Sterilised by irradiation

Sterile: +

Item no.	Product colour	Sterile	Qty. inner / outer
730191	● blue	+	5 / 500



Disposal Bags

Disposal bags made of polypropylene for sterilisation in the steam autoclave. For users of hot-air sterilisers, disposal bags made of polyamide are suitable for use up to +160 °C.

Item no.	Feature	Length	Width	Foil thickness	Nominal capacity	Suitable for steam autoclaves	Suitable for hot air sterilizers	Volume	Material	Qty. inner / outer
BAG1										- / 200
BAG2								30 l		- / 200
BAG3								65 l		- / 200
643201		500 mm	300 mm	0.05 mm	10 l	yes			PP	500 / 500
643203	Imprint "Biohazard"	500 mm	300 mm	0.05 mm	10 l	yes			PP	500 / 500
643401		500 mm	300 mm	0.05 mm	10 l		yes		PA	500 / 500
644201		780 mm	400 mm	0.05 mm	30 l	yes			PP	500 / 500
644203	Imprint "Biohazard"	780 mm	400 mm	0.05 mm	30 l	yes			PP	500 / 500
644401		780 mm	400 mm	0.05 mm	30 l		yes		PA	500 / 500
646201	Imprint "Biohazard"	780 mm	600 mm	0.05 mm	65 l	yes			PP	500 / 500
646203		780 mm	600 mm	0.05 mm	65 l	yes			PP	1 / 500
646401		780 mm	600 mm	0.05 mm	65 l		yes		PA	300 / 300
649201		1,100 mm	700 mm	0.05 mm	130 l	yes			PP	350 / 350
649203	Imprint "Biohazard"	1,100 mm	700 mm	0.05 mm	130 l	yes			PP	350 / 350
649401		1,100 mm	700 mm	0.05 mm	130 l		yes		PA	200 / 200



Greiner Bio-One offers a comprehensive range of tubes and multipurpose beakers for various applications. The vessels are available in different materials, with and without caps and with labelling options.

TUBES / MULTIPURPOSE BEAKERS

/ Tubes without closures	164
Tube Polystyrene	165
Tube Polypropylene	165
Grip Stopper	166
Tube Polypropylene for Storage Box	166
/ Tubes with closures	167
Centrifuge Tubes Polypropylene - 15 ml	168
Centrifuge Tubes Polypropylene - 50 ml	169
CELLreactor	170
Polypropylene Microcentrifuge Tubes	170
Reaction Tubes	171
Tubes with closures Polystyrene	171
Tube Two-position Cap	172
/ Separation Tubes	173
Leucosep 12 ml and 50 ml	174
OncoQuick®	174
/ Multipurpose Containers / Beakers	175
Multipurpose Containers Polystyrene	176
Multipurpose Beaker Polypropylene	176
Polystyrene Multipurpose Containers	177
Containers for Plant Cultures Polystyrene	177
Drosophila Containers	178
Ceaprene stopper	178
Quatrorack 4	179
Handyrack 32	179
Handyrack 64	180
Handyrack 80	180
Handyrack 96	181

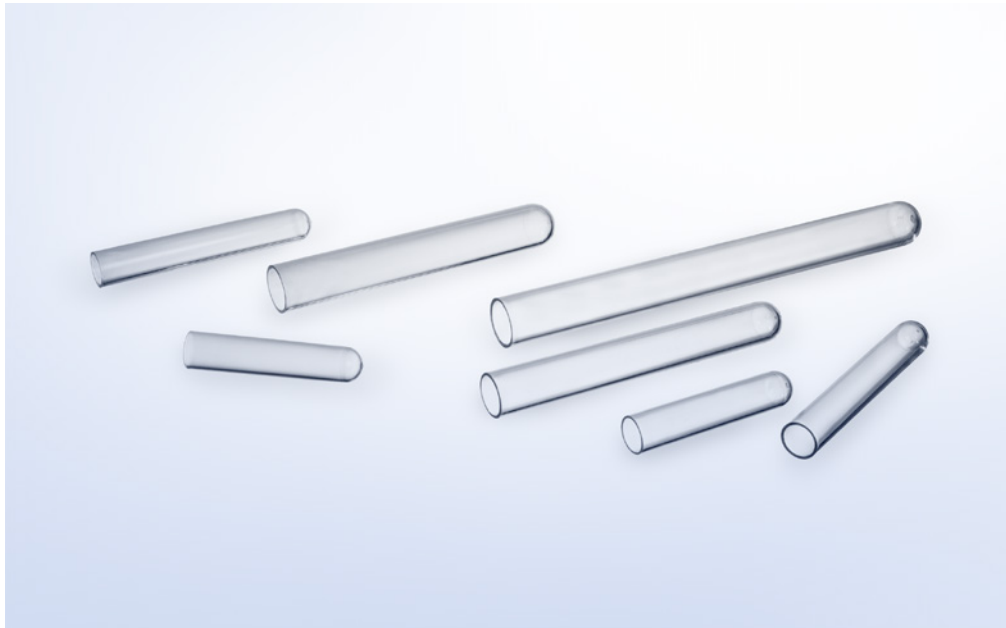

- / For the max. relative centrifugal force (RCF) and the chemical/thermal resistance of our tubes please refer to the technical appendix.

TUBES WITHOUT CLOSURES

The range of Greiner Bio-One tubes is very versatile and meets a wide variety of different demands.

Our tubes are made of different materials: **Polystyrene (PS)** is ideally suited for optical measurements as a result of its high clarity. **Polypropylene (PP)** is

recommended for the storage of chemical and biological samples due to its thermal, mechanical and chemical resistance. Greiner Bio-One tubes without closure are available with round bottom. In addition, it is possible to order appropriate closures in the form of grip stoppers and screw caps.

- / With round or conical bottom
- / With or without skirt
- / Available in polystyrene or polypropylene

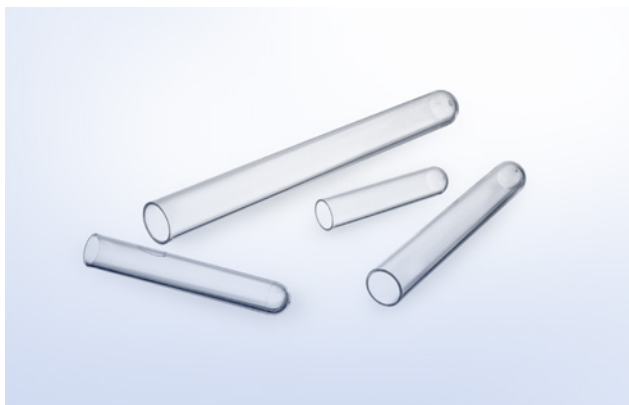
**Tube****Polystyrene**

- / High transparency
- / Available in different sizes and packaging units

Raw material: PS, Bottom shape: round

Item no.	Height	Ø	Working volume	Nominal volume	Qty. inner / outer
112101	55 mm	12 mm	≤3 ml	4 ml	240 / 3,600
115101	75 mm	12 mm	≤4 ml	5 ml	250 / 2,000
136101	100 mm	14 mm	≤8 ml	10 ml	1,400 / 1,400
160101	100 mm	16 mm	≤10.5 ml	12 ml	1,600 / 1,600
187101	100 mm	17 mm	≤12 ml	14 ml	1,500 / 1,500
169101	152 mm	16 mm	≤18 ml	20 ml	1,500 / 1,500

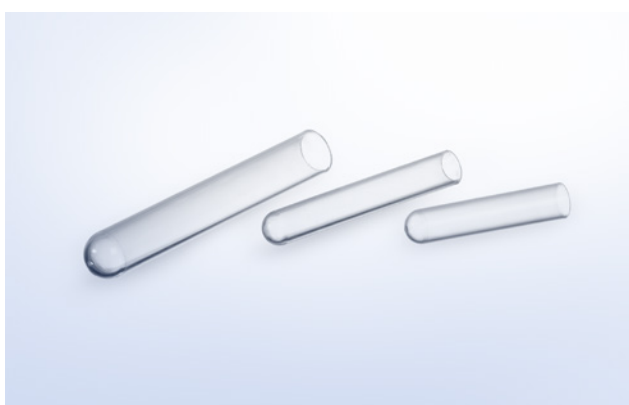
**Tube****Polypropylene**

- / Suited for sample storage
- / Thermal, chemical and mechanical stability
- / Available in different sizes and packaging units

Raw material: PP, Bottom shape: round

Item no.	Height	Ø	Working volume	Nominal volume	Qty. inner / outer
112201	55 mm	12 mm	≤3 ml	4 ml	240 / 3,600
115201	75 mm	12 mm	≤4 ml	5 ml	250 / 2,000
160201	100 mm	16 mm	≤10 ml	12 ml	- / 1,600
187201	100 mm	17 mm	≤12 ml	14 ml	1,500 / 1,500

Tubes / Multipurpose Beakers

Tubes without closures



Grip Stopper

/ Made of high-grade polyethylene

Description: Grip stopper, Raw material: PE

Item no.	Product colour	Suitable for tubes Ø	Qty. inner / outer
303321	○ natural	12 mm	500 / 20,000
310321	○ natural	16 mm	100 / 8,000



Tube

Polypropylene for Storage Box

/ Tubes for storage box item no. 975502

Height: 44 mm, Ø: 8.5 mm, Raw material: PP, Bottom shape: round, Working volume: ≤1 ml, Nominal volume: 1.3 ml

Item no.	Feature	Sterile	Qty. inner / outer
102201	Tube		1,000 / 1,000
102261	tube chain with attached strip cap	+	- / 1,000
102270	tube chain with attached strip cap		- / 1,000



/ For the max. relative centrifugal force (RCF) and the chemical/thermal resistance of our tubes please refer to the technical appendix.



TUBES WITH CLOSURES

Greiner Bio-One tubes with closures are made of different materials: **Polystyrene (PS)** is ideally suited for optical measurements as a result of its high clarity. **Polypropylene (PP)** is recommended for the storage of chemical and biological samples due to its thermal, mechanical and chemical resistance. Greiner Bio-One tubes without

closure are available with round or with conical bottom as well as with or without skirt. They are available in sterile or non-sterile versions. The product range is completed by tubes with a two-position cap. This special cap enables ventilation or an airtight closure of the tube, depending on the position of the stopper.

Tubes / Multipurpose Beakers

Tubes with closures



Centrifuge Tubes

Polypropylene - 15 ml

- / Optimal mechanical, thermal and chemical stability
- / Available with blue or white cap
- / Triple-packed options available
- / Light protection tubes for light-sensitive materials and reactions

STERILE

FREE OF
detectable
DNase

FREE OF
detectable
human DNA

FREE OF
detectable
RNase

 non-
cytotoxic

 non-
pyrogenic

Height: 120 mm, Ø: 17 mm, Support skirt: no, Graduation: yes, Writing field: yes, Raw material: PP, Bottom shape: conical, Working volume: ≤14 ml, Nominal volume: 15 ml, Cap design: screw cap, Sterile: +

Item no.	Feature	Product colour	Cap colour	Colour writing field	Graduation colour	Type of packaging	Sterile	Qty. inner / outer
188261-N		<input type="radio"/> natural	<input checked="" type="radio"/> blue	<input type="radio"/> white	<input checked="" type="radio"/> blue	rack	+	50 / 500
188271-N		<input type="radio"/> natural	<input checked="" type="radio"/> blue	<input type="radio"/> white	<input checked="" type="radio"/> blue	bag	+	50 / 1,000
188271-TRI		<input type="radio"/> natural	<input checked="" type="radio"/> blue	<input type="radio"/> white	<input checked="" type="radio"/> blue	triple packed	+	5 / 500
188281		<input type="radio"/> natural	<input type="radio"/> white	<input type="radio"/> white	<input checked="" type="radio"/> blue	rack	+	50 / 500
188285		<input type="radio"/> natural	<input type="radio"/> white	<input type="radio"/> white	<input checked="" type="radio"/> blue	bag	+	100 / 700
188283	light protection tube	<input checked="" type="radio"/> brown	<input checked="" type="radio"/> blue	<input type="radio"/> white	<input checked="" type="radio"/> blue	rack	+	50 / 500
188280	light protection tube	<input checked="" type="radio"/> brown	<input checked="" type="radio"/> blue	<input type="radio"/> white	<input checked="" type="radio"/> blue	bag	+	100 / 1,000

**Centrifuge Tubes****Polypropylene - 50 ml**

- / Optimal mechanical, thermal and chemical stability
- / Available with blue or white cap
- / Triple-packed options available
- / Light protection tubes for light-sensitive materials and reactions

STERILE

FREE OF
detectable
DNaseFREE OF
detectable
human DNAFREE OF
detectable
RNase
 non-
cytotoxic

 non-
pyrogenic

Height: 115 mm, Ø: 30 mm, Graduation: yes, Writing field: yes, Raw material: PP, Bottom shape: conical, Working volume: ≤50 ml, Nominal volume: 50 ml, Cap design: screw cap, Sterile: +

Item no.	Feature	Support skirt	Product colour	Cap colour	Colour writing field	Graduation colour	Type of packaging	Sterile	Qty. inner / outer
210261		yes	<input type="radio"/> natural	<input checked="" type="radio"/> blue	<input type="radio"/> white	<input checked="" type="radio"/> blue	bag	+	25 / 450
210270		yes	<input type="radio"/> natural	<input checked="" type="radio"/> blue	<input type="radio"/> white	<input checked="" type="radio"/> blue	rack	+	25 / 300
227261		no	<input type="radio"/> natural	<input checked="" type="radio"/> blue	<input type="radio"/> white	<input checked="" type="radio"/> blue	bag	+	20 / 500
227261-N		no	<input type="radio"/> natural	<input checked="" type="radio"/> blue	<input type="radio"/> white	<input checked="" type="radio"/> blue	bag	+	25 / 500
227270		no	<input type="radio"/> natural	<input checked="" type="radio"/> blue	<input type="radio"/> white	<input checked="" type="radio"/> blue	rack	+	25 / 300
227270-N		no	<input type="radio"/> natural	<input checked="" type="radio"/> blue	<input type="radio"/> white	<input checked="" type="radio"/> blue	rack	+	25 / 250
227261-TRI		no	<input type="radio"/> natural	<input checked="" type="radio"/> blue	<input type="radio"/> white	<input checked="" type="radio"/> blue	triple packed	+	5 / 250
227285		no	<input type="radio"/> natural	<input type="radio"/> white	<input type="radio"/> white	<input checked="" type="radio"/> blue	bag	+	20 / 500
227281		no	<input type="radio"/> natural	<input type="radio"/> white	<input type="radio"/> white	<input checked="" type="radio"/> blue	rack	+	25 / 300
227283	light protection tube	no	<input checked="" type="radio"/> brown	<input checked="" type="radio"/> blue	<input type="radio"/> white	<input checked="" type="radio"/> blue	rack	+	25 / 300
227280	light protection tube	no	<input checked="" type="radio"/> brown	<input checked="" type="radio"/> blue	<input type="radio"/> white	<input checked="" type="radio"/> blue	bag	+	20 / 500

/ Please contact your local distribution partner for the availability of 227261-N / 227270-N or 227261 / 227270.

Tubes / Multipurpose Beakers

Tubes with closures



CELLreactor

15 ml and 50 ml polypropylene tube with filter screw cap

- / For cultivation of suspension cells and expansion of aerobic microorganisms
- / Facilitates a high number of parallel experiments
- / Maximal sterility and excellent gas exchange
- / Conical tube design and in-tube harvest

STERILE

FREE OF detectable DNase

FREE OF detectable human DNA

FREE OF detectable RNase

non-cytotoxic

non-pyrogenic

Graduation: yes, Writing field: yes, Raw material: PP, Bottom shape: conical, Cap design: filter screw cap, Sterile: +

Item no.	Height	Ø	Cap colour	Working volume	Nominal volume	Sterile	Qty. inner / outer
188241	120 mm	17 mm	● blue	1 ml - 5 ml	15 ml	+	20 / 500
227245	115 mm	30 mm	● blue	1 ml - 35 ml	50 ml	+	20 / 500

/ Application Note: Cultivation of Suspension and Hybridoma Cells in CELLSTAR® CELLreactor Tubes (F073918)

/ Application Note: Superior protein yields in suspension CHO cells using FectoPRO™-mediated transient transfection in CELLSTAR® CELLreactor (F073926)



Polypropylene Microcentrifuge Tubes

- / Exceptional clarity coupled to a wide thermal range
- / Minimal non-specific binding due to highly polished surfaces
- / Inert polypropylene for safe, long term storage
- / May be centrifuged to 25,000 x g
- / Leak-free performance
- / Extensive range of tube types, cap colours and sterility options

Item no.	Description	Feature	Skirt	Product colour	Qty. inner / outer
693201	Bio Tubes		yes		- / 5,000
692201	Bio Tubes				500 / 5,000
723201	Bio Tubes		yes		- / 5,000
366350	Caps for Bio Tubes	Tethered		○ natural	500 / 5,000
366351	Caps for Bio Tubes	Tethered		○ white	500 / 5,000
366353	Caps for Bio Tubes	Tethered		● red	500 / 5,000
366354	Caps for Bio Tubes	Tethered		● blue	500 / 5,000

Item no.	Description	Feature	Skirt	Product colour	Qty. inner / outer
366355	Caps for Bio Tubes			● green	500 / 5,000
366356	Caps for Bio Tubes	Tethered		● yellow	500 / 5,000
366357	Caps for Bio Tubes	Tethered		● violet	500 / 5,000



STERILE

Reaction Tubes

- / High chemical resistance and temperature tolerance
- / Available in different sizes
- / Available for Eppendorf, Vitatron and Roche systems

Description: Pre-capped, Support skirt: no, Sterile: +

Item no.	Cap colour	Volume	Sterile	Qty. inner / outer
692261	○ white	0.5 ml	+	50 / 2,500
716261	○ white	1.5 ml	+	250 / 2,500
723261	○ white	2 ml	+	250 / 2,500



Tubes with closures

Polystyrene

- / High transparency
- / Available with screw cap or bayonet cap in blue / black / white
- / With or without skirt
- / In bulk or rack packaging

Raw material: PS

Item no.	Height	Ø	Support skirt	Graduation	Writing field	Bottom shape	Cap colour	Working volume	Nominal volume	Cap design	Sterile	Qty. inner / outer
164180	100 mm	16.8 mm	yes	-	no	conical	○ white	≤12 ml	12 ml	bayonet cap		1,300 / 1,300
164161	100 mm	16.8 mm	yes	-	no	conical	● blue	≤12 ml	12 ml	bayonet cap	+	25 / 1,000

Tubes / Multipurpose Beakers

Tubes with closures

Item no.	Height	∅	Support skirt	Graduation	Writing field	Bottom shape	Cap colour	Working volume	Nominal volume	Cap design	Sterile	Qty. inner / outer
163177	100 mm	17 mm	no	-	no	round	● black	≤12 ml	12 ml	screw cap		900 / 900
188161	120 mm	17 mm	no	yes	yes	conical	● blue	≤14 ml	15 ml	screw cap	+	50 / 500
188171	120 mm	17 mm	no	yes	yes	conical	● blue	≤14 ml	15 ml	screw cap	+	100 / 1,000
186171	120 mm	17 mm	no	-	no	round	● blue	≤15 ml	15 ml	screw cap	+	100 / 1,000

/ Item no. 163177 is also available as polypropylene version with white screw cap (item no. 163270).

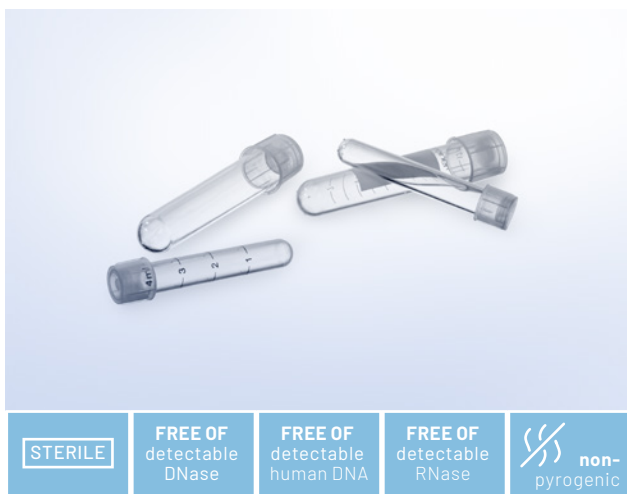

Tube

Two-position Cap

The two-position cap enables ventilation or an airtight closure of the tube, depending on the position of the stopper.

Bottom shape: round, Cap design: Two-position Cap, Sterile: +

Item no.	Height	∅	Graduation	Writing field	Raw material	Graduation colour	Working volume	Nominal volume	Sterile	Qty. inner / outer
115261	75 mm	12 mm	yes	no	PP		≤4 ml	5 ml	+	1 / 1,000
115262	75 mm	12 mm	yes	no	PP		≤4 ml	5 ml	+	25 / 2,000
120161	75 mm	12.4 mm	-	no	PS	● blue	≤4 ml	4.5 ml	+	1 / 1,000
120180	75 mm	12.4 mm	-	no	PS	● blue	≤4 ml	4.5 ml	+	25 / 2,000
187261	95 mm	18 mm	yes	yes	PP		≤12 ml	14 ml	+	1 / 800
187262	95 mm	18 mm	yes	yes	PP		≤12 ml	14 ml	+	25 / 1,000
191161	95 mm	18 mm	-	no	PS		≤12.5 ml	14 ml	+	1 / 750
191180	95 mm	18 mm	-	no	PS		≤12.5 ml	14 ml	+	25 / 1,000



/ For further information, please refer to our website: www.gbo.com



SEPARATION TUBES

Different separation techniques can be used to enrich certain particles (DNA, RNA, proteins, cells etc.) specifically from complex biological mixtures such as cell and tissue homogenates, blood or urine, so that they can then be selectively investigated. The separation of cells by density gradient centrifugation has proven to be the most often used method.

Leucosep has been developed for optimal separation of lymphocytes and peripheral mononuclear cells (so-called PB-MCs) from human whole blood and bone marrow by means of

density gradient centrifugation. The key feature of Leucosep is the porous barrier incorporated into the centrifuge tube made of highly translucent polypropylene.

OncoQuick® is a simple-to-use, rapid and efficient system for the enrichment of circulating tumour cells that are released into the blood by a solid epithelial tumour or malignant melanoma. OncoQuick® combines the advantages of cell separation by density gradient centrifugation with recovery rates that are comparable with immunobead methods.

- / Leucosep for the separation of lymphocytes/ mononuclear cells from blood/bone marrow
- / OncoQuick® for the enrichment of disseminated, circulating tumour cells from peripheral blood



Leucosep

12 ml and 50 ml

Efficient separation of lymphocytes and mononuclear cells from peripheral blood and bone marrow.

- / Easy to fill
- / No re-contamination with unwanted red blood cells
- / PBMC isolation from whole blood in 15 min

Type of sample: blood

Item no.	Separation medium	Bottom shape	Sample volume	Sterile	Qty. inner / outer
163288	pre-filled with Leucosep separation medium	round	3 - 8 ml		50 / 500
163289		round	3 - 8 ml		50 / 500
163290		round	3 - 8 ml	+	50 / 500
227288	pre-filled with Leucosep separation medium	conical	15 - 30 ml		25 / 250
227289		conical	15 - 30 ml		25 / 300
227290		conical	15 - 30 ml	+	25 / 300

/ For IFU please refer to our website: www.gbo.com



OncoQuick®

Enrichment of disseminated, circulating tumour cells from peripheral blood.

- / Time request approx. 45 minutes
- / Reproducible recovery: > 70 %
- / No additional laboratory equipment required
- / Tubes are pre-filled with separation medium

Sample volume: 15 - 30 ml, Type of sample: blood

Item no.	Cap colour	Qty. inner / outer
227255	● blue	1 / 1
227250	● blue	10 / 10

/ For IFU please refer to our website: www.gbo.com



/ For further information, please refer to our website: www.gbo.com



MULTIPURPOSE CONTAINERS / BEAKERS

Multipurpose containers or beakers can be used for a variety of different applications. They can be applied universally for academic and non-human medical purposes. Multipurpose containers are made of polystyrene or polypropylene and are available in different sizes. They feature either plastic or metal caps and can be supplied with or without plain or printed label. **Containers for plant culture** are made of a very clear material which ensures maximum light transmission and thus rapid and successful growth of plant cul-

tures. These culture containers are not only suitable for the proliferation of plant cultures but can also be used as transport containers and are available with or without lids. Our drosophila containers are ideally suited for the cultivation of *Drosophila melanogaster*. The bottom part of the container is made of polystyrene. Drosophila containers can be supplied with a separately orderable ceaprene stopper. This stopper is gas-permeable and made of water-repellent material.

- / Multipurpose containers in polystyrene or polypropylene
- / Polystyrene containers for plant culture
- / Polystyrene drosophila containers



Multipurpose Containers

Polystyrene

- / Manufactured from crystal clear polystyrene
- / Available in different sizes
- / Can be used universally for academic and non-human medical purposes
- / With or without plain or printed label
- / Plastic or metal cap

Raw material: PS, Cap design: screw cap

Item no.	Feature	Height	Ø	Support skirt	Bottom shape	Cap colour	Working volume	Nominal volume	Cap material	Sterile	Qty. inner / outer
201150		91 mm	25 mm	yes	conical	○ white	≤23 ml	30 ml	plastics		400 / 400
201170		91 mm	25 mm	yes	conical	○ white	≤23 ml	30 ml	plastics	+	400 / 400
201152	with plain label	91 mm	25 mm	yes	conical	○ white	≤23 ml	30 ml	plastics		400 / 400
201172	with plain label	91 mm	25 mm	yes	conical	○ white	≤23 ml	30 ml	plastics	+	400 / 400
224170		77 mm	49 mm			● silver	≤80 ml	100 ml	metal		20 / 160
225180	with plain label	115 mm	49 mm			● silver	≤150 ml	150 ml	metal		20 / 120



Multipurpose Beaker

Polypropylene

- / Can be used universally for non human medical purposes
- / Sterile and non-sterile

Height: 70 mm, Ø: 55 mm, Graduation: yes, Working volume: ≤120 ml, Nominal volume: 120 ml, Cap design: screw cap

Item no.	Feature	Product colour	Cap colour	Sterile	Qty. inner / outer
724411		○ natural	○ white		300 / 300
724412		○ natural	○ white	+	300 / 300
724413	Tamper proof label	○ natural	○ white	+	300 / 300
724414		○ natural	● red	+	300 / 300

/ Item No., lot number and expiry date are printed on the screw cap of the beaker to provide additional information and improve traceability



Polystyrene Multipurpose Containers

- / High clarity
- / Can be used universally for in vitro uses
- / Available in different sizes
- / With or without plain or printed label

Item no.	Writing field	Cap material	Sterile	Qty. inner / outer
189176	yes	plastics	+	- /700
189175	yes	plastics		- /700
219102	no	metal		- /300
219190	yes	metal		- /300
224180	yes	metal		- /160
225185	yes	metal		- /120



Containers for Plant Cultures

Polystyrene

The use of a very clear material ensures maximum light transmission and thus rapid growth. These culture containers are not only suitable for the proliferation of plant cultures but can also be used as transport containers.

Height: 100 mm, Raw material: PS

Item no.	Description	Ø	Working volume	Nominal volume	Cap design	Sterile	Qty. inner / outer
960161	container	53 mm	≤150 ml	175 ml	pull cap	+	4 / 300
968177	container, bottom part	68 mm	≤300 ml	330 ml			192 / 192

/ Also available with lid as sterile version.

Tubes / Multipurpose Beakers

Multipurpose Containers / Beakers



Drosophila Containers

- / Ideally suited for the cultivation of *Drosophila melanogaster*
- / Choice of different sizes
- / Bottom part of container made of polystyrene

Description: Drosophila Containers, Raw material: PS

Item no.	Height	Ø	Working volume	Nominal volume	Qty. inner / outer
205101	64 mm	27 mm		28 ml	1,500 / 1,500
217101	82 mm	36 mm		68 ml	605 / 605
960177	100 mm	53 mm	≤150 ml	175 ml	315 / 315

- / Can be supplied with a separately orderable ceaprene stopper. This stopper is gas-permeable and made of water-repellent material.



Ceaprene stopper

- / Gas-permeable
- / Made of water-repellent material

Item no.	Suitable for tubes Ø	Qty. inner / outer
354070	27 mm	- / 1,500
330070	36 mm	- / 605
332070	53 mm	- / 315

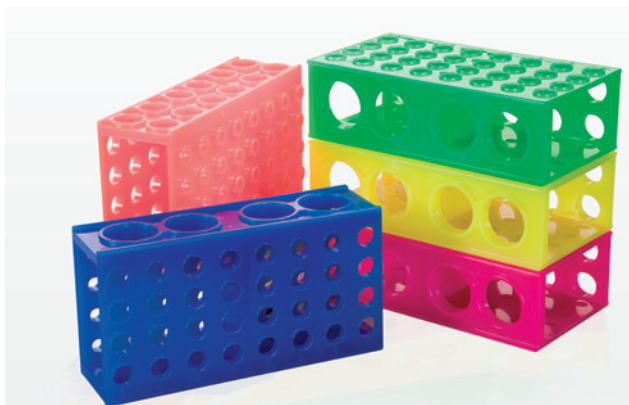
**Quatorack 4**

- / Multi format rack
- / Ideal for a variety of sizes of containers and tubes
- / Capable of supporting vessels up to 30 mm in diameter ie: 50 ml centrifuge tubes

Item no.	Product colour	Qty. inner / outer
999250	● pink	1 / 20
999251	○ natural	- / 20
999254	● blue	1 / 20
999252	● orange	1 / 20
999255	● green	1 / 20
999257	● yellow	1 / 20

**Handyrack 32**

- / 32 (+8) position reversible rack for use with 0.5 and 1.5 ml microtubes
- / One side has 32 wells for 0.5 ml type tubes with 8 larger positions for 1.5 or 2.0 ml tubes
- / Flip side has the opposite configuration: 32 positions for 1.5 ml or 2.0 ml tubes with 8 smaller positions
- / Both sides have moulded indexing
- / Lid available separately

Description: Rack without lid

Item no.	Product colour	Qty. inner / outer
999241	○ natural	- / 20
999242	● orange	1 / 20
999244	● blue	1 / 20
999245	● green	1 / 20
999246	● yellow	1 / 20
999248	● black	1 / 20



Handyrack 64

- / 64 position reversible rack for use with 0.5 and 1.5 ml microtubes
- / 8 rows 8 columns
- / An ideal replacement for card or metal freezer racks
- / Moulded indexing for easy reference
- / Lid available separately

Item no.	Description	Product colour	Qty. inner / outer
999231	Rack without lid	○ natural	- / 20
999232	Rack without lid	● orange	1 / 20
999234	Rack without lid	● blue	1 / 20
999235	Rack without lid	● green	1 / 20
999236	Rack without lid	● yellow	1 / 20
999237	Rack without lid	● violet	1 / 20
999238	Rack without lid	● black	1 / 20
999239	Lid natural for HandyRack 64	○ natural	1 / 20

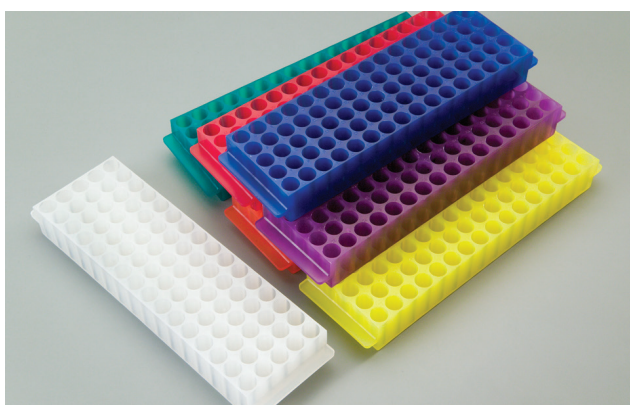

Handyrack 80

- / General purpose 80 position laboratory rack
- / Designed for 1.5 ml and 2ml microtubes and skirted 0.5ml microtubes

Description: Rack without lid

Item no.	Product colour	Qty. inner / outer
999291	○ natural	1 / 20
999292	● orange	1 / 20
999298	● black	1 / 20
999295	● green	1 / 20
999294	● blue	1 / 20
999293	● red	1 / 20
999297	● violet	1 / 20

Item no.	Product colour	Qty. inner / outer
999296	● yellow	1 / 20

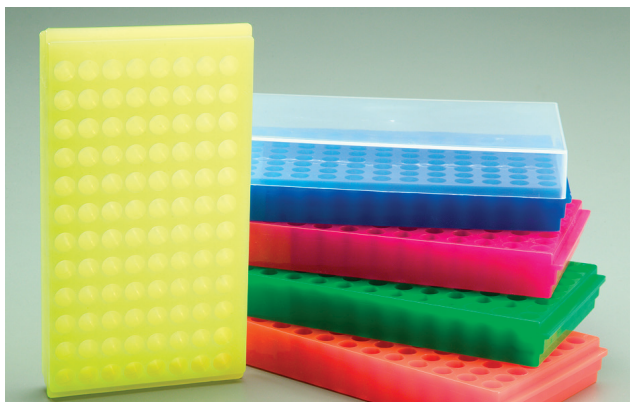

Handyrack 96

- / 96 position reversible rack for use with 0.5 ml and 1.5 ml microtubes
- / 8 rows 12 columns with moulded indexing for easy reference
- / Ideal for pipetting to and from 96-well microplates
- / Lid available separately

Item no.	Description	Product colour	Qty. inner / outer
999201	Rack without lid	○ natural	- /10
999202	Rack without lid	● orange	- /10
999203	Rack without lid	● red	- /10
999204	Rack without lid	● blue	- /10
999205	Rack without lid	● green	- /10
999206	Rack without lid	● yellow	- /10
999207	Rack without lid	● violet	- /10
999208	Rack without lid	● black	- /10
999209	Lid natural for HandyRack 96	○ natural	- /10



For sample freezing and storage, Greiner Bio-One offers a comprehensive product portfolio including Cryo.s tubes, racks as well as electronic equipment for tube closure and sample tracking. With the brand Cryo.s Greiner Bio-One combines more than 30 years of experience in the manufacturing of cryogenic tubes with latest technology and innovation.

CRYOTECHNICS

/	Cryo.s Cryo Tubes	184
	Cryo.s - 1 ml	185
	Cryo.s - 2 ml	186
	Cryo.s - 4 ml	187
	Cryo.s - 5 ml	188
	Cryo.s - Cap inserts	188
	Support Rack	189
	CryoBox 50	189
	Cryo storage box	190
	CryoBox 100	190
/	Cryo.s with Barcode	191
	Cryo.s with Barcode – Preproduced unique codes.....	192
	Cryo.s with Barcode – Customised Codes	192
	48-way Datamatrix Cryo Rack	193
	81-way Datamatrix Cryo Rack	193
/	Cryo.s Biobanking Tubes sterile	194
	Cryo.s Biobanking Tubes sterile 300 µl	195
	Cryo.s Biobanking Tubes non-sterile 300 µl ...	196
	Cryo.s Biobanking Tubes sterile 600 µl	197
	Cryo.s Biobanking Tubes non-sterile 600 µl ...	198
	Cryo.s Biobanking Tubes sterile 1000 µl	199
	Cryo.s Biobanking Tubes non-sterile 1000 µl	200
	Screw Caps Biobanking Tubes	201
	96-way Datamatrix Cryo Rack	201
	Cryo.s Decapper	202
	Single Tube Scanner	202
	Flex-Camera Rack Scanner	203
	ANSI-Camera Rack Scanner	204



- / For a freezing and thawing protocol as well as safety advisory for Cryo.s please refer to the technical appendix.

CRYO.S CRYO TUBES

Cryo.s with datamatrix and linear barcode and Cryo.s biobanking tubes are for storage of tissue, cells, fungi, bacteria, spores, cellular extracts or body fluids at ultra-low temperature for research and development purposes as well as in-vitro diagnostics. They must not be stored in the liquid phase of liquid nitrogen, but only in the gas phase above. Cryo.s tubes are not intended for any application in the context of reproductive medicine.

An outstanding feature of all Cryo.s is the utilisation of a USP class VI certified, medical grade polypropylene for tube manu-

facturing. This material does not release significant amounts of leachables, hence stored samples stay clean and free of contamination. Sterile product versions are sterilised applying an ISO 11137 validated irradiation procedure yielding an SAL level of 10^{-6} .

The portfolio of Cryo.s tubes includes cryogenic tubes with different volumes, different base forms as well as several cap colours. Cryo.s offer several features for the identification and labelling of individual samples, to include coloured screw caps, a white, scratch-resistant writing area and barcoding options.

- / CE-marked
- / USP class VI certified medical grade polypropylene
- / Sterilised applying an ISO 11137 validated irradiation procedure yielding an SAL level of 10^{-6}
- / Suited for storage in liquid nitrogen vapour phase (-196°C)



Cryo.s - 1 ml

- / High thermal resistance
- / Cryo.s with internal thread have a screw cap with silicone gasket
- / Cap inserts item no. 304134 (50 pieces per bag)
- / USP class VI certified medical grade polypropylene

IVD	STERILE	FREE OF detectable DNase	FREE OF detectable human DNA	FREE OF detectable RNase	non-cytotoxic	non-pyrogenic
-----	---------	--------------------------	------------------------------	--------------------------	---------------	---------------

Height: 42 mm, Ø: 12.5 mm, Starfoot: yes, Raw material: PP, Bottom shape: conical, Working volume: ≤1.2 ml, Cap design: screw cap, Sterile: +

Item no.	Barcode	Graduation	Writing field	Cap colour	Thread type	Triple-packed	Sterile	Qty. inner / outer
123261	no	no	no	○ natural	internal		+	100 / 500
123263	no	yes	yes	○ natural	internal		+	100 / 500
123263-TRI	no	yes	yes	○ natural	internal	yes	+	10 / 200
123277	no	yes	yes	● green	internal		+	100 / 500
123278	no	yes	yes	● yellow	internal		+	100 / 500
123279	no	yes	yes	● blue	internal		+	100 / 500
123280	no	yes	yes	● red	internal		+	100 / 500

/ with 150 inserts per case



Cryo.s - 2 ml

- / High thermal resistance
- / Cryo.s with internal thread have a screw cap with silicone gasket
- / Cap inserts item no. 304134 (50 pieces per bag)
- / USP class VI certified medical grade polypropylene

IVD	STERILE	FREE OF detectable DNase	FREE OF detectable human DNA	FREE OF detectable RNase	non-cytotoxic	non-pyrogenic
-----	---------	--------------------------	------------------------------	--------------------------	---------------	---------------

Raw material: PP, Bottom shape: round, Cap design: screw cap, Sterile: +

Item no.	Height	Ø	Starfoot	Barcode	Graduation	Writing field	Cap colour	Working volume	Thread type	Triple-packed	Sterile	Qty. inner / outer
121261	48 mm	12.5 mm	no	no	-	no	○ natural	≤2 ml	internal		+	100 / 500
121263	48 mm	12.5 mm	no	no	yes	yes	○ natural	≤2 ml	internal		+	100 / 500
121277	48 mm	12.5 mm	no	no	yes	yes	● green	≤2 ml	internal		+	100 / 500
121278	48 mm	12.5 mm	no	no	yes	yes	● yellow	≤2 ml	internal		+	100 / 500
121279	48 mm	12.5 mm	no	no	yes	yes	● blue	≤2 ml	internal		+	100 / 500
121280	48 mm	12.5 mm	no	no	yes	yes	● red	≤2 ml	internal		+	100 / 500
122261	48 mm	12.5 mm	yes	no	-	no	○ natural	≤2 ml	internal		+	100 / 500
122263	48 mm	12.5 mm	yes	no	yes	yes	○ natural	≤2 ml	internal		+	100 / 500
122263-TRI	48 mm	12.5 mm	yes	no	yes	yes	○ natural	≤2 ml	internal	yes	+	10 / 200
122277	48 mm	12.5 mm	yes	no	yes	yes	● green	≤2 ml	internal		+	100 / 500
122278	48 mm	12.5 mm	yes	no	yes	yes	● yellow	≤2 ml	internal		+	100 / 500
122279	48 mm	12.5 mm	yes	no	yes	yes	● blue	≤2 ml	internal		+	100 / 500
122280	48 mm	12.5 mm	yes	no	yes	yes	● red	≤2 ml	internal		+	100 / 500
126261	47 mm	12.4 mm	yes	no	-	no	○ natural	≤2.2 ml	external		+	100 / 500
126263	47 mm	12.4 mm	yes	no	yes	yes	○ natural	≤2.2 ml	external		+	100 / 500
126263-TRI	47 mm	12.4 mm	yes	no	yes	yes	○ natural	≤2.2 ml	external	yes	+	10 / 200

Item no.	Height	Ø	Starfoot	Barcode	Graduation	Writing field	Cap colour	Working volume	Thread type	Triple-packed	Sterile	Qty. inner / outer
126277	47 mm	12.4 mm	yes	no	yes	yes	● green	≤2.2 ml	external		+	100 / 500
126278	47 mm	12.4 mm	yes	no	yes	yes	● yellow	≤2.2 ml	external		+	100 / 500
126279	47 mm	12.4 mm	yes	no	yes	yes	● blue	≤2.2 ml	external		+	100 / 500
126280	47 mm	12.4 mm	yes	no	yes	yes	● red	≤2.2 ml	external		+	100 / 500

/ with 150 inserts per case



Cryo.s - 4 ml

- / High thermal resistance
- / Cap inserts item no. 304134 (50 pieces per bag)
- / USP class VI certified medical grade polypropylene

IVD	STERILE	FREE OF detectable DNase	FREE OF detectable human DNA	FREE OF detectable RNase	non-cytotoxic	non-pyrogenic
-----	---------	--------------------------	------------------------------	--------------------------	---------------	---------------

Description: Cryo.s 4 ml, Height: 83 mm, Ø: 12.4 mm, Starfoot: yes, Raw material: PP, Bottom shape: round, Working volume: ≤4 ml, Cap design: screw cap, Sterile: +

Item no.	Barcode	Graduation	Writing field	Cap colour	Thread type	Sterile	Qty. inner / outer
127261	no	no	no	○ natural	external	+	50 / 300
127263	no	yes	yes	○ natural	external	+	50 / 300
127277	no	yes	yes	● green	external	+	50 / 300
127278	no	yes	yes	● yellow	external	+	50 / 300
127279	no	yes	yes	● blue	external	+	50 / 300
127280	no	yes	yes	● red	external	+	50 / 300

/ with 100 inserts per case



Cryo.s - 5 ml

- / High thermal resistance
- / Cryo.s with internal thread have a screw cap with silicone gasket
- / Cap inserts item no. 304134 (50 pieces per bag)
- / USP class VI certified medical grade polypropylene

IVD	STERILE	FREE OF detectable DNase	FREE OF detectable human DNA	FREE OF detectable RNase	non-cytotoxic	non-pyrogenic
-----	---------	--------------------------	------------------------------	--------------------------	---------------	---------------

Description: Cryo.s 5 ml, Height: 86 mm, Ø: 12.5 mm, Starfoot: no, Raw material: PP, Bottom shape: round, Working volume: ≤4.5 ml, Cap design: screw cap, Sterile: +

Item no.	Barcode	Graduation	Writing field	Cap colour	Thread type	Sterile	Qty. inner / outer
124261	no	-	no	○ natural	internal	+	50 / 300
124263	no	yes	yes	○ natural	internal	+	50 / 300
124273	no	yes	yes	● red	internal	+	50 / 300
124275	no	yes	yes	● green	internal	+	50 / 300
124276	no	yes	yes	● yellow	internal	+	50 / 300
124274	no	yes	yes	● blue	internal	+	50 / 300

/ with 100 inserts per case



Cryo.s - Cap inserts

Description: cap inserts for Cryo.s, Raw material: PS, Suitable for Cryo.s: 1 / 2 / 4 / 5 ml

Item no.	Product colour	Qty. inner / outer
304134	○ white	50 / 17,500



Support Rack

- / Suitable for Cryo.s with starfoot base (Item No. 122XXX, 123XXX, 126XXX, 127XXX)
- / Improved handling since the tubes can be opened with one hand
- / Rubber base to prevent slipping
- / Offers space for up to 40 Cryo.s

Description: support rack for one-hand operation, Height: 22 mm, Length: 200 mm, Width: 100 mm, Raw material: PC

Item no.	Rack colour	Qty. inner / outer
802501	● blue	1 / 50



CryoBox 50

- / 50 position cryogenic storage box
- / Versatile storage from freezer to bench
- / Dimensions:139 x 86 x 54 mm
- / Hinged lid
- / Stores up to 2.0 ml tubes
- / Suitable for temperatures as low as -90oC

Item no.	Product colour	Qty. inner / outer
802212	● orange	1 / 20
802216	● yellow	1 / 20

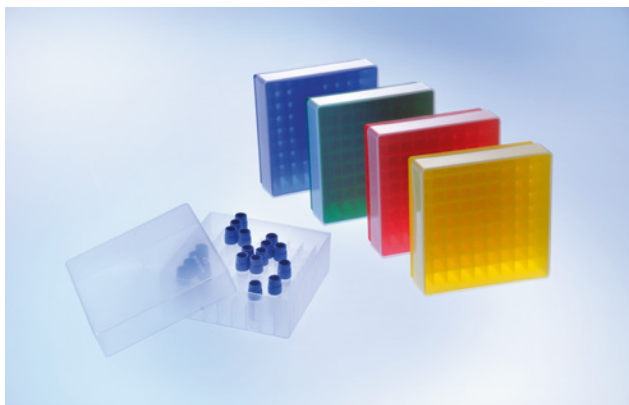

Cryo storage box

The box material polypropylene is very temperature and shock resistant, thus allowing storage temperatures as low as -90°C .

- / Holds 81 Cryo.s sample tubes
- / Transparent lid for optimum visibility of box content

Description: Cryo storage box, Height: 51 mm, Length: 126.5 mm, Width: 126.5 mm, Raw material: PP

Item no.	Rack colour	Qty. inner / outer
802202	○ natural	5 / 20
802203	● red	5 / 20
802204	● blue	5 / 20
802206	● yellow	5 / 20
802225	● green	5 / 20

/ The indicated height refers to the Cryo Storage Box filled with 2 ml Cryo.s and covered with a lid.



CryoBox 100

- / 100 position cryogenic storage box
- / Versatile storage from freezer to bench
- / Dimensions: 151 x 139 x 54 mm
- / Hinged lid
- / Stores up to 2.0 ml tubes
- / Suitable for temperatures as low as -90°C

Item no.	Product colour	Qty. inner / outer
828210	○ natural	5 / 20



/ For further information, please refer to our website: www.gbo.com



- / Datamatrix code ECC200 on the tube bottom with reliable Reed-Solomon error correction
- / Linear barcode type 128 with plain text on the tube side
- / Application of barcodes and datamatrix codes by means of innovative laser technology
- / 100 % controlled code readability
- / Suited for storage in liquid nitrogen vapour phase (-196 °C)
- / Coded tubes are suitable for airfreight (IATA conformity)

CRYO.S WITH BARCODE

Cryo.s with datamatrix and linear barcode and Cryo.s bio-banking tubes are for storage of tissue, cells, fungi, bacteria, spores, cellular extracts or body fluids at ultra-low temperature for research and development purposes as well as in-vitro diagnostics. They must not be stored in the liquid phase of liquid nitrogen, but only in the

gas phase above. Cryo.s tubes are not intended for any application in the context of reproductive medicine.

With Cryo.s with Datamatrix and the accessory racks in 48-way and 81-way formats, Greiner Bio-One expands its portfolio by optimum solutions for semi-automated and automated sample handling and storage.



Cryo.s with Barcode

– Preproduced unique codes

- / Pre-produced unique datamatrix code ECC 200 with 14 x 14 dots on tube bottom, additional linear barcode type 128 with human readable text on tube side
- / Highest code resistance against chemicals, mechanical stress and extremely low storage temperatures (down to -196 °C)

IVD	STERILE	FREE OF detectable DNase	FREE OF detectable human DNA	FREE OF detectable RNase	non-cytotoxic	non-pyrogenic
-----	---------	--------------------------	------------------------------	--------------------------	---------------	---------------

Starfoot: yes, Barcode type: linear barcode and datamatrix code, Raw material: PP, Cap design: screw cap, Sterile: +

Item no.	Height	Ø	Bar-code	Bottom shape	Cap colour	Working volume	Thread type	Sterile	Qty. inner / outer
123263-2DG	42 mm	12.5 mm	yes	conical	○ natural	≤1.2 ml	internal	+	100 / 500
122263-2DG	48 mm	12.5 mm	yes	round	○ natural	≤2 ml	internal	+	100 / 500
126263-2DG	47 mm	12.4 mm	yes	round	○ natural	≤2.2 ml	external	+	100 / 500
127263-2DG	83 mm	12.4 mm	yes	round	○ natural	≤4 ml	external	+	50 / 300

/ Other screw cap colours on request.



Cryo.s with Barcode

– Customised Codes

- / Customised datamatrix code ECC 200 with 14 x 14 dots on tube bottom, additional customised linear barcode type 128 with human readable text on tube side
- / Highest code resistance against chemicals, mechanical stress and extremely low storage temperatures (down to -196 °C)

IVD	STERILE	FREE OF detectable DNase	FREE OF detectable human DNA	FREE OF detectable RNase	non-cytotoxic	non-pyrogenic
-----	---------	--------------------------	------------------------------	--------------------------	---------------	---------------

Starfoot: yes, Barcode type: linear barcode and datamatrix code, Raw material: PP, Cap design: screw cap, Sterile: +

Item no.	Height	Ø	Barcode	Bottom shape	Cap colour	Working volume	Nominal volume	Thread type	Sterile	Qty. inner / outer
123263-2D3	42 mm	12.5 mm	yes	conical	○ natural	≤1.2 ml	1 ml	internal	+	100 / 500
122263-2D3	48 mm	12.5 mm	yes	round	○ natural	≤2 ml	2 ml	internal	+	100 / 500
126263-2D1	47 mm	12.4 mm	yes	round	○ natural	≤2.2 ml	2 ml	external	+	100 / 500

Item no.	Height	Ø	Barcode	Bottom shape	Cap colour	Working volume	Nominal volume	Thread type	Sterile	Qty. inner / outer
127263-2D1	83 mm	12.4 mm	yes	round	○ natural	≤4 ml	4 ml	external	+	50 / 300

/ Custom barcode orders have a minimum order quantity of 10,000 tubes per order and request.

/ Other screw cap colours on request.

/ Barcodes to be specified in order form F071004.



48-way Datamatrix Cryo Rack

- / SLAS-standard format
- / Automation compatible
- / Suitable for storage in vapour phase above liquid nitrogen
- / Barcoded versions on request

Length: 85.5 mm, Width: 127.8 mm, Raw material: PP, Lid type: with lid

Item no.	Description	Height	Barcode	Rack colour	Suitable for Cryo.s	Qty. inner / outer
803202	low rack	52.5 mm	no	● black	1 / 2 ml	- / 20
803270	high rack	88.5 mm	no	● black	4 ml	- / 15



81-way Datamatrix Cryo Rack

- / Shock-proof and temperature-resistant polycarbonate
- / Stacking feature and rotation stoppers
- / 133 x 133 mm footprint for storage in classic freezer setups
- / Suitable for storage in vapour phase above liquid nitrogen
- / Barcoded versions on request

Length: 132.4 mm, Width: 132.4 mm, Raw material: PC, Lid type: with lid

Item no.	Description	Height	Rack colour	Suitable for Cryo.s	Qty. inner / outer
802576	low rack	52 mm	● black	1 / 2 ml	1 / 10
802506	high rack	88.1 mm	● black	4 ml	1 / 10



- / Forum No. 21: Sample Storage Tubes as Quality-Critical Components in Biobanking (F073072)
- / You can find more information about this product in our web-shop.



CRYO.S BIOBANKING TUBES STERILE

With Cryo.s biobanking tubes, Greiner Bio-One offers an ideal solution for the efficient storage of biological samples in large-scale biorepositories.

Cryo.s biobanking tubes are available with working volumes of 235 µl, 580 µl and 975 µl and offered in highly automation-friendly 96-way racks. The innovative design of tubes and racks allows for a very space-efficient storage with up to 30 % better utilisation of storage space in freezers or liquid ni-

trogen tanks.

Cryo.s with datamatrix and linear barcode and Cryo.s biobanking tubes are for storage of tissue, cells, fungi, bacteria, spores, cellular extracts or body fluids at ultra-low temperature for research and development purposes as well as in-vitro diagnostics. They must not be stored in the liquid phase of liquid nitrogen, but only in the gas phase above. Cryo.s tubes are not intended for any application in the context of reproductive medicine.

- / Application of barcodes and datamatrix codes by means of innovative laser technology
- / 100 % controlled code readability
- / Coded tubes are suitable for airfreight (IATA conformity)
- / Suited for storage at -20 °C, -80 °C and in vapour phase above liquid nitrogen



Cryo.s Biobanking Tubes sterile

300 µl

- / Pre-produced unique datamatrix code on tube, datamatrix code and linear barcode on rack
- / Height-reduced screw cap conserving up to 30 % freezer space
- / Customised code sequences on request (order form F071003)
- / Sterile

IVD	STERILE	FREE OF detectable DNase	FREE OF detectable human DNA	FREE OF detectable RNase	non-cytotoxic	non-pyrogenic
-----	---------	--------------------------	------------------------------	--------------------------	---------------	---------------

Height: 18.7 mm, Total rack height: 21.6 mm, Ø: 8.8 mm, Barcode type: datamatrix code, Raw material: PP, Working volume: ≤235 µl, Cap design: screw cap, Sterile: +

Item no.	Barcode	Cap colour	Thread type	Type of packaging	Sterile	Qty. inner / outer
976561	yes	○ natural	internal	rack	+	480 / 960
976566	yes	● green	internal	rack	+	480 / 960
976565	yes	● yellow	internal	rack	+	480 / 960
976564	yes	● blue	internal	rack	+	480 / 960
976563	yes	● red	internal	rack	+	480 / 960
976568	yes	● pink	internal	rack	+	480 / 960
976569	yes	● brown	internal	rack	+	480 / 960
976567	yes	● black	internal	rack	+	480 / 960
131263	yes	○ natural	internal	bulk	+	480 / 960

- / Follow the instructions of use provided within each box.
- / USP class VI certified medical grade polypropylene



Cryo.s Biobanking Tubes non-sterile

300 µl

- / Pre-produced unique datamatrix code on tube, datamatrix code and linear barcode on rack
- / Height-reduced screw cap conserving up to 30 % freezer space
- / Customised code sequences on request (order form F071003)

		FREE OF detectable DNase	FREE OF detectable human DNA	FREE OF detectable RNase	non-cytotoxic	non-pyrogenic
--	--	--------------------------	------------------------------	--------------------------	---------------	---------------

Height: 18.7 mm, Total rack height: 21.6 mm, Ø: 8.8 mm, Barcode type: datamatrix code, Raw material: PP, Working volume: ≤235 µl

Item no.	Barcode	Cap colour	Cap design	Thread type	Type of packaging	Qty. inner / outer
976570	yes		without screw cap	internal	rack	480 / 960
976580	yes	○ natural	screw cap	internal	rack	480 / 960
976586	yes	● green	screw cap	internal	rack	480 / 960
976585	yes	● yellow	screw cap	internal	rack	480 / 960
976584	yes	● blue	screw cap	internal	rack	480 / 960
976583	yes	● red	screw cap	internal	rack	480 / 960
976588	yes	● pink	screw cap	internal	rack	480 / 960
976589	yes	● brown	screw cap	internal	rack	480 / 960
976587	yes	● black	screw cap	internal	rack	480 / 960
131202	yes	○ natural	screw cap	internal	bulk	480 / 960

- / Follow the instructions of use provided within each box.
- / USP class VI certified medical grade polypropylene



Cryo.s Biobanking Tubes sterile

600 µl

- / Pre-produced unique datamatrix code on tube, datamatrix code and linear barcode on rack
- / Height-reduced screw cap conserving up to 30 % freezer space
- / Customised code sequences on request (order form F071003)
- / Sterile

IVD

STERILE

FREE OF
detectable
DNaseFREE OF
detectable
human DNAFREE OF
detectable
RNase
 non-
cytotoxic

 non-
pyrogenic

Height: 33.3 mm, Total rack height: 36.2 mm, Ø: 8.8 mm, Barcode type: datamatrix code, Raw material: PP, Working volume: ≤580 µl, Cap design: screw cap, Sterile: +

Item no.	Barcode	Cap colour	Thread type	Type of packaging	Sterile	Qty. inner / outer
977561	yes	○ natural	internal	rack	+	192 / 960
977566	yes	● green	internal	rack	+	192 / 960
977565	yes	● yellow	internal	rack	+	192 / 960
977564	yes	● blue	internal	rack	+	192 / 960
977563	yes	● red	internal	rack	+	192 / 960
977568	yes	● pink	internal	rack	+	192 / 960
977569	yes	● brown	internal	rack	+	192 / 960
977567	yes	● black	internal	rack	+	192 / 960
132263	yes	○ natural	internal	bulk	+	192 / 960

/ Follow the instructions of use provided within each box.

/ USP class VI certified medical grade polypropylene



Cryo.s Biobanking Tubes non-sterile

600 µl

- / Pre-produced unique datamatrix code on tube, datamatrix code and linear barcode on rack
- / Height-reduced screw cap conserving up to 30 % freezer space
- / Customised code sequences on request (order form F071003)

		FREE OF detectable DNase	FREE OF detectable human DNA	FREE OF detectable RNase	non-cytotoxic	non-pyrogenic
--	--	--------------------------	------------------------------	--------------------------	---------------	---------------

Height: 33.3 mm, Total rack height: 36.2 mm, Ø: 8.8 mm, Barcode type: datamatrix code, Raw material: PP, Working volume: ≤580 µl

Item no.	Barcode	Cap colour	Cap design	Thread type	Type of packaging	Qty. inner / outer
977570	yes		without screw cap	internal	rack	192 / 960
977580	yes	○ natural	screw cap	internal	rack	192 / 960
977586	yes	● green	screw cap	internal	rack	192 / 960
977585	yes	● yellow	screw cap	internal	rack	192 / 960
977584	yes	● blue	screw cap	internal	rack	192 / 960
977583	yes	● red	screw cap	internal	rack	192 / 960
977588	yes	● pink	screw cap	internal	rack	192 / 960
977589	yes	● brown	screw cap	internal	rack	192 / 960
977587	yes	● black	screw cap	internal	rack	192 / 960
132202	yes	○ natural	screw cap	internal	bulk	192 / 960

- / Follow the instructions of use provided within each box.
- / USP class VI certified medical grade polypropylene



Cryo.s Biobanking Tubes sterile
1000 µl

- / Pre-produced unique datamatrix code on tube, datamatrix code and linear barcode on rack
- / Height-reduced screw cap conserving up to 30 % freezer space
- / Customised code sequences on request (order form F071003)
- / USP class VI certified medical grade polypropylene
- / Sterile

IVD	STERILE	FREE OF detectable DNase	FREE OF detectable human DNA	FREE OF detectable RNase
non-cytotoxic	non-pyrogenic			

Height: 50.8 mm, Total rack height: 53.9 mm, Ø: 8.8 mm, Barcode type: datamatrix code, Raw material: PP, Working volume: ≤975 µl, Cap design: screw cap, Sterile: +

Item no.	Barcode	Cap colour	Thread type	Type of packaging	Sterile	Qty. inner / outer
978561	yes	○ natural	internal	rack	+	192 / 960
978566	yes	● green	internal	rack	+	192 / 960
978565	yes	● yellow	internal	rack	+	192 / 960
978564	yes	● blue	internal	rack	+	192 / 960
978563	yes	● red	internal	rack	+	192 / 960
978568	yes	● pink	internal	rack	+	192 / 960
978569	yes	● brown	internal	rack	+	192 / 960
978567	yes	● black	internal	rack	+	192 / 960
133263	yes	○ natural	internal	bulk	+	192 / 960

- / Follow the instructions of use provided within each box.
- / USP class VI certified medical grade polypropylene



Cryo.s Biobanking Tubes non-sterile

1000 µl

- / Pre-produced unique datamatrix code on tube, datamatrix code and linear barcode on rack
- / Height-reduced screw cap conserving up to 30 % freezer space
- / Customised code sequences on request (order form F071003)
- / USP class VI certified medical grade polypropylene

		FREE OF detectable DNase	FREE OF detectable human DNA	FREE OF detectable RNase	non-cytotoxic	non-pyrogenic
--	--	--------------------------	------------------------------	--------------------------	---------------	---------------

Height: 50.8 mm, Total rack height: 53.9 mm, Ø: 8.8 mm, Barcode type: datamatrix code, Raw material: PP, Working volume: ≤975 µl

Item no.	Barcode	Cap colour	Cap design	Thread type	Type of packaging	Qty. inner / outer
978570	yes		without screw cap	internal	rack	192 / 960
978580	yes	○ natural	screw cap	internal	rack	192 / 960
978586	yes	● green	screw cap	internal	rack	192 / 960
978585	yes	● yellow	screw cap	internal	rack	192 / 960
978584	yes	● blue	screw cap	internal	rack	192 / 960
978583	yes	● red	screw cap	internal	rack	192 / 960
978588	yes	● pink	screw cap	internal	rack	192 / 960
978589	yes	● brown	screw cap	internal	rack	192 / 960
978587	yes	● black	screw cap	internal	rack	192 / 960
133202	yes	○ natural	screw cap	internal	bulk	192 / 960

- / Follow the instructions of use provided within each box.
- / USP class VI certified medical grade polypropylene



Screw Caps
Biobanking Tubes

- / 96 screw caps in cap carrier
- / Non-sterile

CE	IVD	FREE OF detectable DNase	FREE OF detectable human DNA	FREE OF detectable RNase	non-cytotoxic	non-pyrogenic
----	-----	--------------------------	------------------------------	--------------------------	---------------	---------------

Description: 96 screw caps in cap carrier, Raw material: PP, Cap design: screw cap

Item no.	Barcode	Cap colour	Qty. inner / outer
385270	no	○ natural	960 / 960
385276	no	● green	960 / 960
385275	no	● yellow	960 / 960
385274	no	● blue	960 / 960
385273	no	● red	960 / 960
385278	no	● pink	960 / 960
385279	no	● brown	960 / 960
385277	no	● black	960 / 960

96-way Datamatrix Cryo Rack



- / Pre-produced unique datamatrix code ECC 200 and linear barcode type 128
- / Made from polycarbonate

CE	IVD	FREE OF detectable DNase	FREE OF detectable human DNA	FREE OF detectable RNase	non-cytotoxic	non-pyrogenic
----	-----	--------------------------	------------------------------	--------------------------	---------------	---------------

Barcode type: linear barcode and datamatrix code, Raw material: PC

Item no.	Height	Barcode	Rack colour	Suitable for Cryo.s	Qty. inner / outer
976501	19.1 mm	yes	● black	300 µl	5 / 10
977501	33.7 mm	yes	● black	600 µl	2 / 10

Item no.	Height	Barcode	Rack colour	Suitable for Cryo.s	Qty. inner / outer
978501	51.4 mm	yes	● black	1000 µl	2 / 10



Cryo.s Decapper

The new Cryo.s Decapper enables the precise simultaneous de- and recapping of cryotubes.

- / Individual motors for precise application of defined torque values
- / 6 channel version for 1, 2 and 4 ml Cryo.s in 48 way cryo racks
- / 8 channel version for Cryo.s Biobanking Tubes
- / Docking station

Content kit: 1 Decapper, Power supply unit, Docking station with charging function, Quick start guide

Item no.	Description	Plug	Qty. inner / outer
852076-UK	6-channel decapper	UK	- /1
852078-UK	8-channel decapper	UK	- /1



Single Tube Scanner

Ideal for single tube data input or secondary storage checks for audit purposes from existing large collections. Merely place the tube, with its coded surface, above the scanning window for the code to be added to your application.

- / Universal tube code recognitions
- / Single USB cable combines power source and data transfer
- / Easy installation
- / Exports immediately to open software portal – e.g: Excel cell, database field or word processor document
- / 5 year warranty

Height: 60 mm, Length: 90 mm, Width: 60 mm

Item no.	Qty. inner / outer
849082	- /1



Flex-Camera Rack Scanner

The Flex-Camera Rack scanner represents the most comprehensive offering from within the Greiner Bio-One scanner range. This is due to its ability to scan a vast range of rack types from SBS/ANSI (24, 48, 96, 240, 384 tube position) to legacy box formats (81 and 100 position). The innovative software supplied with this model allows for automatic rack type identification or user directed rack format scanning SBS/ANSI and legacy rack formats.

- / Single rack scanning time; 2 seconds
- / Export formats: XML, text, Excel, JSON, XML and image files
- / Scanner area condensation reduction glass coating as standard
- / Optional One-dimensional barcode attachment scanner on request
- / 5 year warranty

Height: 146 mm, Length: 174 mm, Width: 152 mm

Item no.	Qty. inner / outer
849081	- / 1



ANSI-Camera Rack Scanner

The ANSI-Camera Scanner provides a compact solution to users looking to scan racks within the SBS/ANSI standard dimensions. This includes, 24, 48, 96, 240 and 384 well racks. The reduced profile and recent product improvements make the ANSI-Camera Scanner an excellent replacement for flat-bed scanner based legacy scanners, whilst remaining cost effective. The innovative software supplied with this model allows for automatic rack-type identification or user directed rack format scanning within available SBS/ANSI racks formats.

- / Single rack scanning time; 2 seconds
- / Suitable for standard SBS/ANSI format racks in 24, 48, 96 and 384 positions
- / Export formats: XML, text, Excel, JSON, XML and image files
- / Scanner area condensation reduction glass coating as standard
- / Optional One-dimensional barcode attachment scanner on request
- / 5 year warranty

Height: 80 mm, Length: 208 mm, Width: 135 mm

Item no.	Qty. inner / outer
849080	- / 1



For the handling and analysis of chemical and biological samples with small or medium volumes, Greiner Bio-One offers a wide range of different analyser cups and reaction vessels with corresponding closures and cuvettes.

REACTION TUBES / ANALYSER CUPS

/	Reaction Tubes Analyser Cups	208
	Reaction Tubes	209
	Reaction Tubes 5 ml	209
	Closures for Reaction Tubes	210
	Analyser Cups	210
/	Semi-micro / Macro Cuvette	211
	Semi-micro / Macro Cuvette	212

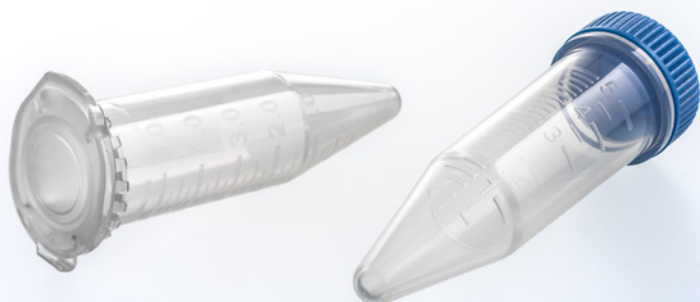

/ For the max. relative centrifugal force (RCF), please refer to the technical appendix.

REACTION TUBES ANALYSER CUPS

Reaction tubes from Greiner Bio-One are available in many different versions. They have a high chemical and temperature resistance and are available from 0.5 ml to 5 ml for small and medium volumes. The reaction tubes are made of high-quality polypropylene and are available with or without lid. The lids of the corresponding vessels are flat and frosted to ensure easy labelling.

Brown reaction tubes have been specially developed for working with light-sensitive sample material. For working with liquid volumes from 1 to 5 ml, Greiner Bio-One offers 5 ml reaction tubes with screw cap or snap

cap. The tubes are also made of highly transparent polypropylene and allow contamination-free access when pipetting medium sample volumes. They also have a frosted, writable surface. This ensures reliable sample identification in everyday laboratory work.

Analyser cups are available with conical or flat bottom design and with or without cap. All analyser cups are manufactured of highly transparent polystyrene. The volumes range from 1.7 ml up to 25 ml. We offer analyser cups that are suitable for the analytical systems of Hitachi or Coulter/Hycel.

- / For volumes from 0.5 ml up to 5 ml
- / With or without cap
- / With or without graduation



FREE OF detectable DNase

FREE OF detectable human DNA

FREE OF detectable RNase

non-pyrogenic

Reaction Tubes

- / High chemical resistance and temperature tolerance
- / Flat, frosted lids and caps for easy labelling
- / Brown tube for light-sensitive materials

Description: reaction tube

Item no.	Feature	Support skirt	Graduation	Product colour	Volume range	Caps attached	Cap design	Sterile	Qty. inner / outer
667201	Vitatron		-	○ natural	≤0.5 ml	yes	snap cap		1.000 / 10.000
616201	universal		yes	○ natural	≤1.5 ml	yes	snap cap		500 / 4.000
616283	universal		yes	● brown	≤1.5 ml	yes	snap cap		500 / 4.000
623201	universal		yes	○ natural	≤2 ml	yes	snap cap		500 / 4.000
716201		no	yes	○ natural	≤1.5 ml		screw cap		500 / 5.000
717201		yes	yes	○ natural	≤1.5 ml		screw cap		500 / 5.000
722201		yes	yes	○ natural	≤2 ml		screw cap		500 / 5.000
616261	universal		yes	○ natural	≤1,5 ml	yes	snap cap	+	500 / 4.000

/ Coloured versions of item no. 616201 and 623201 as well as sterile versions of all tubes are available on request.



FREE OF detectable DNase

FREE OF detectable human DNA

FREE OF detectable RNase

non-pyrogenic

Reaction Tubes

5 ml

5 ml reaction tubes with either a snap cap for fast opening and closing or a screw cap for secure sample storage.

- / Outer diameter and shape similar to 15 ml tube
- / Resealable packaging

Description: reaction tube, Support skirt: no, Graduation: yes, Raw material: PP

Item no.	Product colour	Cap colour	Caps attached	Cap design	Sterile	Qty. inner / outer
725201	○ natural	● blue		screw cap		100 / 500

Item no.	Product colour	Cap colour	Caps attached	Cap design	Sterile	Qty. inner / outer
725261	○ natural	● blue		screw cap	+	50 / 500
622201	○ natural		yes	snap cap		100 / 1.000
622261	○ natural		yes	snap cap	+	100 / 1.000

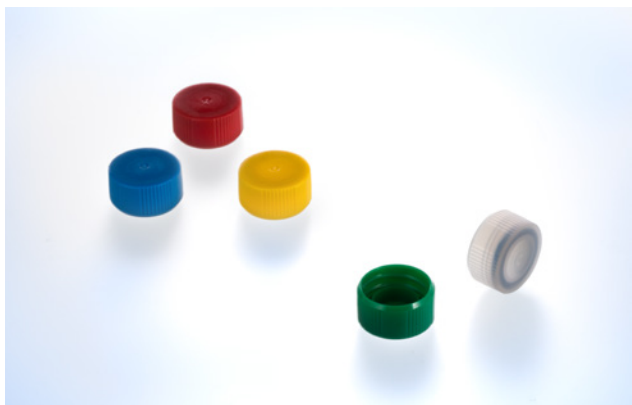

Closures for Reaction Tubes

- / Suitable for item no. 716XXX, 717XXX and 722XXX
- / Available in natural, red, blue, green and yellow
- / With gasket

FREE OF
detectable
DNase

FREE OF
detectable
human DNA

FREE OF
detectable
RNase

non-
pyrogenic

Description: screw cap, Feature: with sealing ring, Suitable for tubes Ø: 12 mm, Cap design: screw cap

Item no.	Product colour	Qty. inner / outer
366380	○ natural	500 / 5.000
366383	● red	500 / 5.000
366384	● blue	500 / 5.000
366385	● green	500 / 5.000
366386	● yellow	500 / 5.000



Analyser Cups

- / For handling and analysis of chemical and biological samples
- / Available for different analytical systems

Description: analyser cup, Raw material: PS, Caps attached: no

Item no.	Feature	Support skirt	Bottom shape	Volume range	Lid type	Qty. inner / outer
668102	Coulter / Hycel	no	flat	≤25 ml	with lid	250 / 1.250
729101	Hitachi	yes	conical	≤1.7 ml	without lid	250 / 5.000



/ For further information, please refer to our website: www.gbo.com



SEMI-MICRO / MACRO CUVETTE

Cuvettes are used for UV/VIS spectroscopy. Greiner Bio-One offers semi-micro cuvettes with a total volume of 1.6 ml and macro cuvettes with a total volume of 4 ml. Both versions are made of crystal-clear polystyrene and are particularly suitable for enzymatic determinations, as the

very thin wall thickness enables fast and even temperature control. Our cuvettes are characterised by their low light scattering combined with a high transmission rate. Semi-micro and macro cuvettes can be used in a wavelength range from 340 nm to 900 nm.

- / Available as semi-micro or macro cuvettes
- / Very thin walls for fast and even temperature control
- / Low light scattering and high transmission rate
- / Suitable for a wavelength range from 340-900 nm

Reaction Tubes / Analyser Cups

Semi-micro / Macro Cuvette



Semi-micro / Macro Cuvette

- / Ideal for enzymatic determinations
- / Manufactured from crystal clear polystyrene
- / Minimal light scatter but high transmission rate
- / Applicable wavelength from 340 to 900 nm

Height: 45 mm, Length: 12.5 mm, Width: 12.5 mm, Pathlength: 10 mm, Raw material: PS

Item no.	Description	Working volume	Total volume	Qty. inner / outer
613101	semi-micro cuvette	≥0.95 ml	1.6 ml	100 / 1.000
614101	macro cuvette	≥2.5 ml	4 ml	100 / 1.000

/ Cuvettes



PCR (Polymerase Chain Reaction) is an important molecular biological method to determine processes in living organisms at the molecular level or genetic changes in the genetic material. It is used for the detection of diseases and parentage relationships as well as in forensics.

MOLECULAR BIOLOGY

/	Sapphire PCR Tubes.....	216
	PCR Tubes	217
	PCR 8-Tube Strips	218
	Sapphire PCR 8-Cap Strips	219
	Sapphire PCR 8-Cap Strips	219
	PCR 12-Tube Strips	220
	PCR 12-Tube Cap Strips	221
	White qPCR 8- and 12- Tube Strips and Caps .	221
/	Sapphire PCR Microplates.....	222
	96 Well PCR Microplates	223
	384 Well PCR Microplates	223
	White qPCR 96 Well Microplates	224

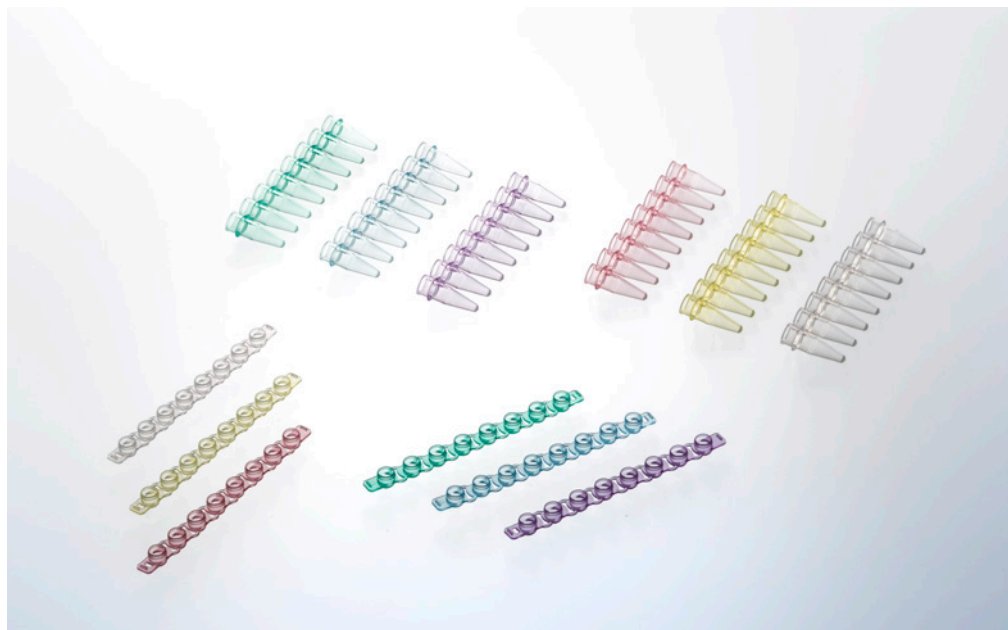

- / For standard reaction tubes please refer to chapter reaction tubes / analyser cups.

SAPPHIRE PCR TUBES

The Sapphire PCR tube portfolio comprises a full range of PCR reaction tubes (0.2 ml and 0.5 ml) as well as PCR 8-tube strips and the matching 8-cap strips.

The thin wall construction optimises the heat transfer from the block to the reaction solution. PCR tubes with flat caps are suitable for real-time / quantitative PCR and have frosted caps for easy labelling.

The classical Sapphire PCR 8-tube strips are also available

with individually attached caps. The angular attached domed or flat caps can be closed and opened individually minimising the risk of cross contamination. Moreover, individual closing and opening helps to avoid pipetting errors and facilitates sample processing.

PCR 8-tube strips are also available as **low profile tubes** with a well volume of 0.1 ml ideal for FAST, standard and real-time PCR supporting the reduction of cycle time without compromises in accuracy and efficiency.

- / Manufactured out of medical-grade polypropylene without interfering additives
- / Thin-walled for efficient heat transfer during amplification
- / Comprehensive thermal cycler compatibility



PCR Tubes

Tubes with flat caps are suitable for realtime/quantitative PCR and have frosted caps for easy labelling.

/ Packaging labelled with product symbols



Description: PCR tube, Raw material: PP

Item no.	Product colour	Volume	Volume range	Caps attached	Cap design	Lid type	Qty. inner / outer
671201	○ natural	0.2 ml	≤0.2 ml	yes	individually attached	domed	1,000 / 10,000
671273	● red	0.2 ml	≤0.2 ml	yes	individually attached	domed	1,000 / 10,000
671274	● blue	0.2 ml	≤0.2 ml	yes	individually attached	domed	1,000 / 10,000
671275	● green	0.2 ml	≤0.2 ml	yes	individually attached	domed	1,000 / 10,000
671276	● yellow	0.2 ml	≤0.2 ml	yes	individually attached	domed	1,000 / 10,000
671277	● violet	0.2 ml	≤0.2 ml	yes	individually attached	domed	1,000 / 10,000
671281	assorted	0.2 ml	≤0.2 ml	yes	individually attached	domed	1,000 / 10,000
683201	○ natural	0.2 ml	≤0.2 ml	yes	individually attached	flat	1,000 / 10,000
683273	● red	0.2 ml	≤0.2 ml	yes	individually attached	flat	1,000 / 10,000
683274	● blue	0.2 ml	≤0.2 ml	yes	individually attached	flat	1,000 / 10,000
683275	● green	0.2 ml	≤0.2 ml	yes	individually attached	flat	1,000 / 10,000
683276	● yellow	0.2 ml	≤0.2 ml	yes	individually attached	flat	1,000 / 10,000
683277	● violet	0.2 ml	≤0.2 ml	yes	individually attached	flat	1,000 / 10,000
683271	assorted	0.2 ml	≤0.2 ml	yes	individually attached	flat	1,000 / 10,000
682201	○ natural	0.5 ml	≤0.5 ml	yes	individually attached	flat	1,000 / 10,000
682273	● red	0.5 ml	≤0.5 ml	yes	individually attached	flat	1,000 / 10,000
682274	● blue	0.5 ml	≤0.5 ml	yes	individually attached	flat	1,000 / 10,000

Item no.	Product colour	Volume	Volume range	Caps attached	Cap design	Lid type	Qty. inner / outer
682275	● green	0.5 ml	≤0.5 ml	yes	individually attached	flat	1,000 / 10,000
682276	● yellow	0.5 ml	≤0.5 ml	yes	individually attached	flat	1,000 / 10,000
682277	● violet	0.5 ml	≤0.5 ml	yes	individually attached	flat	1,000 / 10,000
682281	assorted	0.5 ml	≤0.5 ml	yes	individually attached	flat	1,000 / 10,000
684201	○ natural	0.2 ml	≤0.2 ml	no		without lid	1,000 / 10,000

/ Assorted colour contains the following colours: red, blue, green, yellow, violet

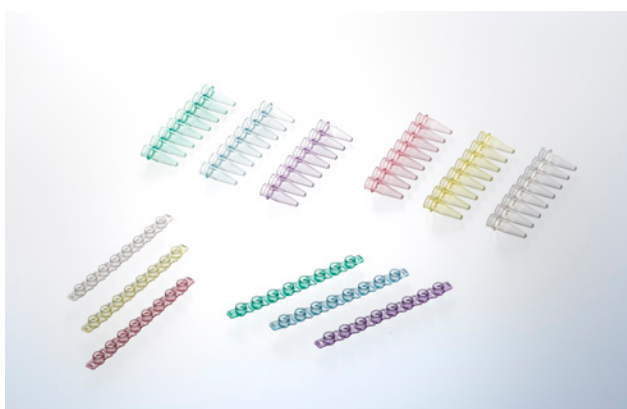

PCR 8-Tube Strips

- / Thin wall for optimal heat transfer
- / Low evaporation rate in PCR
- / Also available with individually attached caps or as low-profile version
- / Packaging labelled with product symbols

FREE OF detectable DNase	FREE OF detectable human DNA	FREE OF detectable RNase	non-pyrogenic	PCR
--------------------------	------------------------------	--------------------------	---------------	-----

Description: PCR 8-Tube Strips, Raw material: PP

Item no.	Feature	Product colour	Volume range	Caps attached	Cap design	Lid type	Qty. inner / outer
673210		○ natural	≤0.2 ml	no	separate cap strip		125 / 1,250
673273		● red	≤0.2 ml	no	separate cap strip		125 / 1,250
673274		● blue	≤0.2 ml	no	separate cap strip		125 / 1,250
673275		● green	≤0.2 ml	no	separate cap strip		125 / 1,250
673276		● yellow	≤0.2 ml	no	separate cap strip		125 / 1,250
673277		● violet	≤0.2 ml	no	separate cap strip		125 / 1,250
673271		assorted	≤0.2 ml	no	separate cap strip		125 / 1,250
671221	low profile	○ natural	≤0.1 ml	yes	individually attached	flat	120 / 1,200
608281		○ natural	≤0.2 ml	yes	individually attached	flat	120 / 1,200

/ Assorted colour contains the following colours: red, blue, green, yellow, violet



Sapphire PCR 8-Cap Strips

- / Thin wall for optimal heat transfer
- / Low evaporation rate in PCR

FREE OF detectable DNase	FREE OF detectable human DNA	FREE OF detectable RNase	non-pyrogenic	PCR
--------------------------	------------------------------	--------------------------	---------------	-----

Volume: 0.2 ml, Caps attached: yes, Cap design: individually attached

Item no.	Product colour	Qty. inner / outer
608283	● red	- / 1.200
608284	● blue	- / 1.200
608285	● green	- / 1.200
608286	● yellow	- / 1.200
608287	● violet	- / 1.200



Sapphire PCR 8-Cap Strips

- / Real-time PCR cap strips (Item No. 373250) have a flat lid and are made of highly transparent polypropylene
- / These are ideal for real-time PCR applications and are compatible with most real-time PCR devices

FREE OF detectable DNase	FREE OF detectable human DNA	FREE OF detectable RNase	non-pyrogenic	PCR
--------------------------	------------------------------	--------------------------	---------------	-----

Description: 8-cap strips, Raw material: PP

Item no.	Feature	Product colour	Qty. inner / outer
373270		○ natural	125 / 1,250
373273		● red	125 / 1,250
373274		● blue	125 / 1,250
373275		● green	125 / 1,250
373276		● yellow	125 / 1,250

Item no.	Feature	Product colour	Qty. inner / outer
373277		● violet	125 / 1,250
373281		assorted	125 / 1,250
373250	for RT PCR	○ natural	125 / 1,250

/ Assorted colour contains the following colours: red, blue, green, yellow, violet



PCR 12-Tube Strips

- / Thin wall for optimal heat transfer
- / Low evaporation rate in PCR

FREE OF detectable DNase	FREE OF detectable human DNA	FREE OF detectable RNase	non-pyrogenic	PCR
--------------------------	------------------------------	--------------------------	---------------	-----

Volume: 0.2 ml, Caps attached: no

Item no.	Product colour	Qty. inner / outer
674201	○ natural	- /800
674275	● green	- /800
674274	● blue	- /800
674276	● yellow	- /800
674277	● violet	- /800



FREE OF detectable DNase	FREE OF detectable human DNA	FREE OF detectable RNase	non-pyrogenic	PCR
--------------------------	------------------------------	--------------------------	---------------	-----

PCR 12-Tube Cap Strips

- / Compatible with 674201, 674274, 674275, 674276 & 674277

Item no.	Cap colour	Qty. inner / outer
374270	○ natural	- /800
374273	● red	- /800
374274	● blue	- /800
374275	● green	- /800
374276	● yellow	- /800



FREE OF detectable DNase	FREE OF detectable human DNA	FREE OF detectable RNase	non-pyrogenic	PCR
--------------------------	------------------------------	--------------------------	---------------	-----

White qPCR 8- and 12- Tube Strips and Caps

- / Strips of flat caps
- / Optically clear caps ideal for qPCR
- / Caps supplied as separate strips, attached strips or individually hinged caps

Volume: 0.2 ml, Cap design: separate cap strip

Item no.	Description	Product colour	Cap colour	Qty. inner / outer
671251	12-tube strips	○ white	○ clear	80 / 800
671271	8-tube strips	○ white	○ clear	125 / 1,250

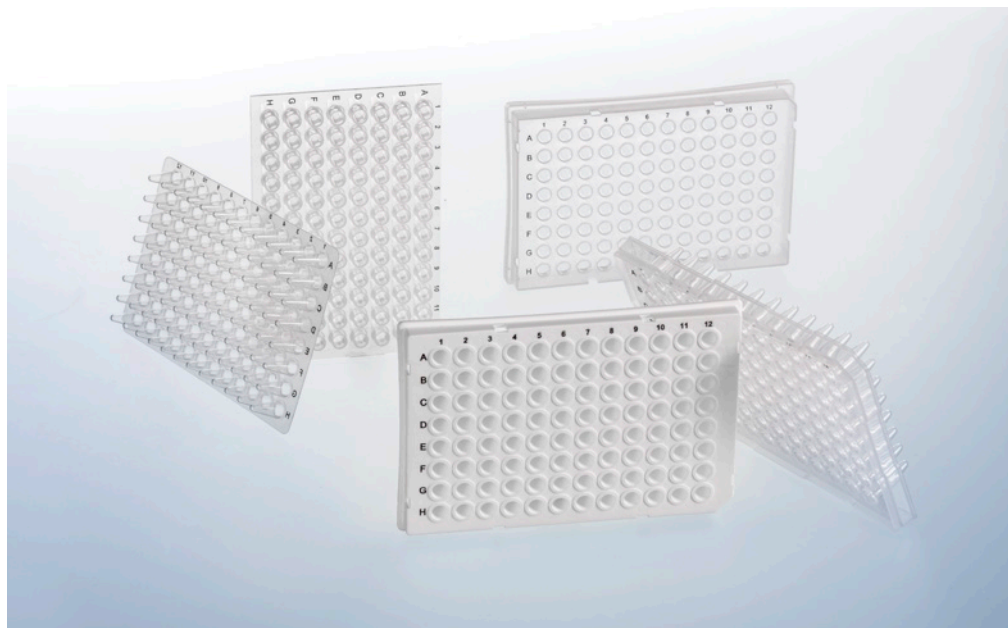

/ For details regarding plate geometry as well as compability with thermal cyclers, please refer to the technical appendix.

SAPPHIRE PCR MICROPLATES

The use of the 96 well format allows the scale up of basic PCR work, while the 384 well format is ideal for high-throughput screening projects.

All microplates are made of thin-walled polypropylene. This op-

timises the heat transfer from the thermoblock to the reaction solution. Our heat-resistant sealers AMPLIseal, VIEWseal and SILVERseal are ideal for sealing the microplates during PCR, and the 96 well microplate may also be sealed with 8-cap strips.

- / Available in 96 well and 384 well format
- / Ultra-thin polypropylene for optimal heat transfer
- / Sealable with sealers SILVERseal, VIEWseal and AMPLIseal

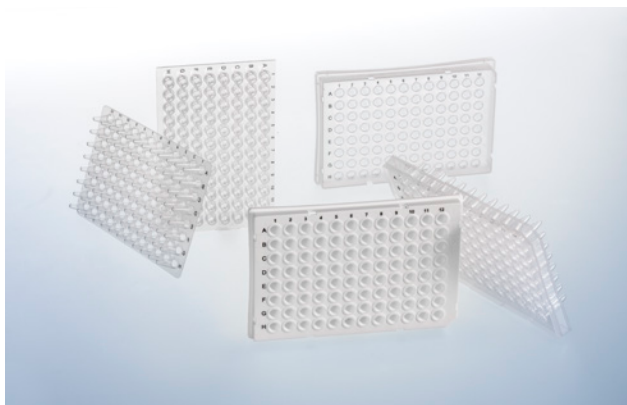

96 Well PCR Microplates

- / Without skirt, half-skirt and full-skirt
- / Alphanumeric printing for rapid sample identification
- / Sealable with sealers SILVERseal , VIEWseal and AMPLIseal or with compatible 8-cap strips
- / Low profile microplate for reduced sample volume and cycle time

Well format: 96, Raw material: PP, Well volume, max: 0.2 ml

Item no.	Feature	Skirt	Product colour	Colour alphanumeric code	Qty. inner / outer
652201		without skirt	○ natural	● black	10 / 100
652250	flat, universal	without skirt	○ natural	● black	10 / 100
669285	suitable for LightCycler®	half-skirt	○ white	● black	10 / 100
652290	suitable for ABI	half-skirt	○ natural	● black	10 / 100
652260	ABI design	half-skirt	○ natural	● black	10 / 100
652270		yes	○ natural	● black	10 / 100

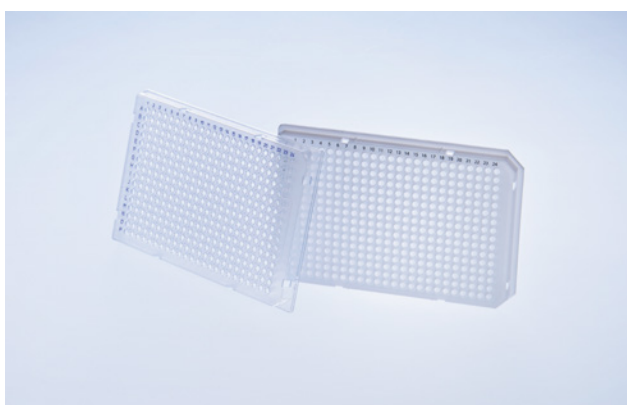

384 Well PCR Microplates

- / Thin wall for optimal heat transfer
- / Alphanumeric well coding
- / Sealable with sealers SILVERseal , VIEWseal and AMPLIseal
- / White and black microplate versions are available on request

Well format: 384, Skirt: yes, Raw material: PP, Total volume (well): 25 µl

Item no.	Feature	Product colour	Colour alphanumeric code	Qty. inner / outer
785290	suitable for ABI	○ natural	● blue	15 / 60
785285	suitable for LightCycler®	○ white	● black	50 / 100

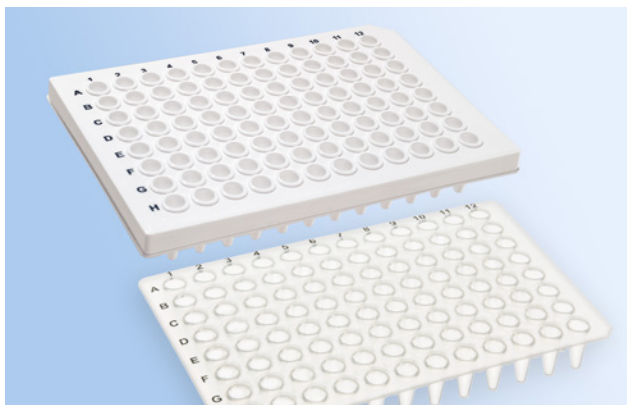

White qPCR 96 Well Microplates

- / Standard and low profile wells
- / Non-skirted, half-skirted and fully skirted versions
- / Sealable with Greiner Bio-One sealers
- / White polypropylene
- / Suitable 8-cap strip Cat.-No. 373 260

FREE OF
detectable
DNase

FREE OF
detectable
human DNA

FREE OF
detectable
RNase

 non-
pyrogenic

 PCR

Item no.	Description	Feature	Skirt	Volume	Qty. inner / outer
669225	A12 corner notch	Well profile: standard	half-skirt	0.1 ml	10 / 100
669215	A12 corner notch	Well profile: low profile	without skirt	0.1 ml	20 / 100
669205	A12 corner notch	Well profile: standard	without skirt	0.2 ml	10 / 100
669255	A1 corner notch, raised rim	Well profile: low profile	half-skirt	0.1 ml	10 / 100



To achieve consistent, reproducible results when handling liquids in the laboratory, reliable dispensers and pipette tips are essential. With high quality materials and pipetting solutions, maximum precision can be achieved while reducing the consumption of reagents and time. Comfortable and fatigue-free working is also crucial for everyday laboratory life.

LIQUID HANDLING

/	Sapphire Pipettes	228
	Single-Channel Pipettes	229
	Multi-Channel Pipettes	229
	ID Clip for Sapphire Pipettes	230
	Pipette Carrousel	230
	Pipette Holder	231
	ID Clip for Sapphire Pipettes	231
/	Sapphire Pipette Tips	232
	Pipette Tips 10 µl	233
	Pipette Tips 10 µl extended	234
	Filter Tips 20 µl	235
	Filter Tips 100 µl	235
	Pipette Tips 200 µl	236
	Pipette Tips 300 µl	237
	Pipette Tips 1000 µl	238
	Pipette Tips 1250 µl	238
	Racks (unfilled)	239
	Macro Pipette Tip 1-5 ml	240
/	CELLSTAR® Serological Pipettes	241
	Serological Pipettes	242
	Serological Pipettes Triple-packed	243
	Serological Pipettes Special Models	243
	MaxiPette	244
	Pasteur / Serum Pipettes	244
	Pasteur / Serum Pipettes	245



/ Watch our video:



SAPPHIRE PIPETTES

Sapphire pipettes are a variable volume range of air-displacement pipettes designed and built to deliver optimal performance, ergonomics, and robustness in day-to-day use.

The lightweight design coupled with a state-of-the-art mechanism reduces pipetting forces and makes our pipettes both comfortable and easy-to-use. The contoured body shape allows for a relaxed grip whatever size your hand, and the 3-position tip ejector button makes

pipetting comfortable for both left-handed and right-handed users. The colour-coded push button allows for easier identification of the relevant tips.

Sapphire pipettes provide an excellent performance within ISO 8655 which is considered the basis for determining the accuracy and precision of air-displacement pipettes. In combination with Sapphire pipette tips they show one of the lowest error tolerances on the market. All Sapphire pipettes are fully autoclavable.

- / Outstanding accuracy and precision
- / Ergonomic design and minimal pipetting forces for a new level of comfort
- / Lightweight, robust and fully autoclavable
- / Digital volume setting
- / Colour-coded for tip identification



Single-Channel Pipettes

- / Light and comfortable design
- / Low pipetting forces for ease of use
- / Digital volume setting
- / Colour-coded for tip identification
- / 5 ml & 10 ml pipettes without ejector lever
- / Fully autoclavable

Description: single-channel pipette

Item no.	Colour code	Volume range	Qty. inner / outer
89000002	orange	0.2 - 2 µl	1 / 1
89000010	red	1 - 10 µl	1 / 1
89000020	light yellow	2 - 20 µl	1 / 1
89000100	light orange color_circle	10 - 100 µl	1 / 1
89000200	yellow	20 - 200 µl	1 / 1
89001000	blue	100 - 1,000 µl	1 / 1
89000500	violet	500 - 5,000 µl	1 / 1
89010000	light blue	1000 - 10,000 µl	1 / 1

/ Spare parts and other accessories available on request



Multi-Channel Pipettes

- / Light and comfortable design
- / Low pipetting forces for ease of use
- / Digital volume setting
- / Colour-coded for tip identification
- / Optimised for use with Greiner Bio-One tips
- / Fully autoclavable

Item no.	Description	Colour code	Volume range	Qty. inner / outer
89000810	8-channel pipette	red	0.5 - 10 µl	1 / 1
89000820	8-channel pipette	light yellow	2 - 20 µl	1 / 1

Item no.	Description	Colour code	Volume range	Qty. inner / outer
89008200	8-channel pipette	● yellow	20 - 200 µl	1 / 1
89008300	8-channel pipette	● green	20 - 300 µl	1 / 1
89001210	12-channel pipette	● red	0.5 - 10 µl	1 / 1
89001220	12-channel pipette	● light yellow	2 - 20 µl	1 / 1
89012200	12-channel pipette	● yellow	20 - 200 µl	1 / 1
89012300	12-channel pipette	● green	20 - 300 µl	1 / 1

/ Spare parts and other accessories available on request



Pipette Carousel

- / Holds up to 7 pipettes
- / Robust and space-saving
- / Holds single and multi-channel pipettes



Item no.	Qty. inner / outer
89000099	1 / 1



Pipette Holder

- / Wall mounted single pipette holder
- / Keeps pipette within reach
- / Robust and space-saving
- / Self adhesive or screw fix



Item no.	Qty. inner / outer
89000098	- / 1

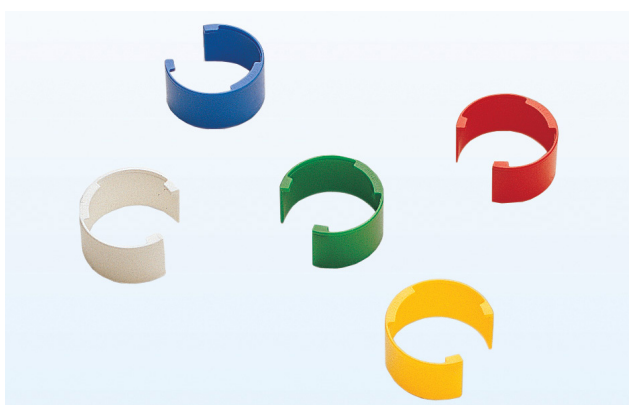

ID Clip for Sapphire Pipettes

- / For identification/personalisation of your pipette
- / Clips into place to help avoid mix-ups
- / Writeable with permanent ink
- / 5 colours available



Item no.	Product colour	Qty. inner / outer
89019801	○ white	- / 10
89019803	● red	- / 10
89019806	● yellow	- / 10
89019804	● blue	- / 10
89019809	assorted	- / 10
89019805	● green	- / 10



/ Watch our video:



SAPPHIRE PIPETTE TIPS

We understand that flexibility is critical in terms of modern liquid handling solutions. This is why the Sapphire tips are manufactured in eight different sizes in a volume range from 10 μ l to 1250 μ l, including an extended length 10 μ l tip for the recovery of small sample volumes.

All our tips are made of medi-

cal grade polypropylene and are available as standard, low-retention, filter or low-retention filter tips.

Depending on the format, Sapphire pipette tips are packed in racks, bulk or refill units. Sapphire tips and pipettes when used together provide a fully optimised and harmonised liquid handling solution.

- / Fully automated production and packaging
- / Universal fit for all common pipettes
- / Tips (without filter) and racks are autoclavable
- / Coloured box inserts for easy volume identification
- / Low retention surface properties for high recovery rate and maximum precision



Pipette Tips

10 µl

- / Universal fit for all common pipettes
- / Tips (without filter) and racks are autoclavable
- / Easy-to-read graduation
- / Colour-coded for tip identification

FREE OF detectable DNase	FREE OF detectable human DNA	FREE OF detectable RNase	non-cytotoxic	non-pyrogenic	PCR
--------------------------	------------------------------	--------------------------	---------------	---------------	-----

Raw material: PP, Volume range: 0.2 - 10 µl, Nominal volume: 10 µl, Matching rack: 770310

Item no.	Feature	Product colour	Box insert colour	Type of packaging	Sterile	Qty. inner / outer
771350	standard	<input type="radio"/> natural	<input checked="" type="radio"/> red	bag		1,000 / 10,000
771351	standard	<input type="radio"/> natural	<input checked="" type="radio"/> red	rack		960 / 5,760
771352	standard	<input type="radio"/> natural	<input checked="" type="radio"/> red	rack	+	960 / 5,760
771354	standard	<input type="radio"/> natural	<input checked="" type="radio"/> red	refill		960 / 4,800
771355	standard	<input type="radio"/> natural	<input checked="" type="radio"/> red	refill	+	960 / 4,800
771361	low retention	<input type="radio"/> natural	<input checked="" type="radio"/> red	rack		960 / 5,760
771362	low retention	<input type="radio"/> natural	<input checked="" type="radio"/> red	rack	+	960 / 5,760
771364	low retention	<input type="radio"/> natural	<input checked="" type="radio"/> red	refill		960 / 4,800
771365	low retention	<input type="radio"/> natural	<input checked="" type="radio"/> red	refill	+	960 / 4,800
771353	filter	<input type="radio"/> natural	<input checked="" type="radio"/> red	rack	+	960 / 5,760
771363	low retention filter	<input type="radio"/> natural	<input checked="" type="radio"/> red	rack	+	960 / 5,760



Pipette Tips 10 µl extended

- / Extended 10 µl tip for better recovery of small sample volumes
- / Universal fit for all common pipettes
- / Tips (without filter) and racks are autoclavable
- / Easy-to-read graduation

FREE OF
detectable
DNase

FREE OF
detectable
human DNA

FREE OF
detectable
RNase



Raw material: PP, Volume range: 0.5 - 10 µl, Nominal volume: 10 µl, Matching rack: 770310

Item no.	Feature	Product colour	Box insert colour	Type of packaging	Sterile	Qty. inner / outer
772350	standard	○ natural	● red	bag		1,000 / 5,000
772351	standard	○ natural	● red	rack		960 / 5,760
772352	standard	○ natural	● red	rack	+	960 / 5,760
772354	standard	○ natural	● red	refill		960 / 4,800
772355	standard	○ natural	● red	refill	+	960 / 4,800
772361	low retention	○ natural	● red	rack		960 / 5,760
772362	low retention	○ natural	● red	rack	+	960 / 5,760
772364	low retention	○ natural	● red	refill		960 / 4,800
772365	low retention	○ natural	● red	refill	+	960 / 4,800
772353	filter	○ natural	● red	rack	+	960 / 5,760
772363	low retention filter	○ natural	● red	rack	+	960 / 5,760



Filter Tips

20 µl

- / Prevent contamination with liquids and aerosols during pipetting
- / filters manufactured without additives
- / Easy-to-read graduation
- / Colour-coded for tip identification

STERILE	FREE OF detectable DNase	FREE OF detectable human DNA	FREE OF detectable RNase	non-cytotoxic	non-pyrogenic	PCR
---------	--------------------------	------------------------------	--------------------------	---------------	---------------	-----

Raw material: PP, Volume range: 2 - 20 µl, Nominal volume: 20 µl, Type of packaging: rack, Sterile: +

Item no.	Feature	Product colour	Box insert colour	Sterile	Qty. inner / outer
773353	filter	<input type="radio"/> natural	<input checked="" type="radio"/> orange	+	960 / 5,760
773363	low retention filter	<input type="radio"/> natural	<input checked="" type="radio"/> orange	+	960 / 5,760



Filter Tips

100 µl

- / Prevent contamination with liquids and aerosols during pipetting
- / filters manufactured without additives
- / Easy-to-read graduation
- / Colour-coded for tip identification

STERILE	FREE OF detectable DNase	FREE OF detectable human DNA	FREE OF detectable RNase	non-cytotoxic	non-pyrogenic	PCR
---------	--------------------------	------------------------------	--------------------------	---------------	---------------	-----

Raw material: PP, Volume range: 5 - 100 µl, Nominal volume: 100 µl, Type of packaging: rack, Sterile: +

Item no.	Feature	Product colour	Box insert colour	Sterile	Qty. inner / outer
774353	filter	<input type="radio"/> natural	<input checked="" type="radio"/> dark yellow	+	960 / 5,760
774363	low retention filter	<input type="radio"/> natural	<input checked="" type="radio"/> dark yellow	+	960 / 5,760



Pipette Tips

200 µl

- / Universal fit for all common pipettes
- / Tips (without filter) and racks are autoclavable
- / Easy-to-read graduation
- / Colour-coded for tip identification

FREE OF detectable DNase	FREE OF detectable human DNA	FREE OF detectable RNase	non-cytotoxic	non-pyrogenic	PCR
--------------------------	------------------------------	--------------------------	---------------	---------------	-----

Raw material: PP, Volume range: 5 - 200 µl, Nominal volume: 200 µl, Matching rack: 770320

Item no.	Feature	Product colour	Box insert colour	Type of packaging	Sterile	Qty. inner / outer
775350	standard	<input type="radio"/> natural	<input checked="" type="radio"/> yellow	bag		1,000 / 15,000
775351	standard	<input type="radio"/> natural	<input checked="" type="radio"/> yellow	rack		960 / 5,760
775352	standard	<input type="radio"/> natural	<input checked="" type="radio"/> yellow	rack	+	960 / 5,760
775354	standard	<input type="radio"/> natural	<input checked="" type="radio"/> yellow	refill		960 / 4,800
775355	standard	<input type="radio"/> natural	<input checked="" type="radio"/> yellow	refill	+	960 / 4,800
775361	low retention	<input type="radio"/> natural	<input checked="" type="radio"/> yellow	rack		960 / 5,760
775362	low retention	<input type="radio"/> natural	<input checked="" type="radio"/> yellow	rack	+	960 / 5,760
775364	low retention	<input type="radio"/> natural	<input checked="" type="radio"/> yellow	refill		960 / 4,800
775365	low retention	<input type="radio"/> natural	<input checked="" type="radio"/> yellow	refill	+	960 / 4,800
775353	filter	<input type="radio"/> natural	<input checked="" type="radio"/> yellow	rack	+	960 / 5,760
775363	low retention filter	<input type="radio"/> natural	<input checked="" type="radio"/> yellow	rack	+	960 / 5,760



Pipette Tips

300 µl

- / Universal fit for all common pipettes
- / Tips (without filter) and racks are autoclavable
- / Easy-to-read graduation
- / Colour-coded for tip identification

FREE OF detectable DNase	FREE OF detectable human DNA	FREE OF detectable RNase	non-cytotoxic	non-pyrogenic	PCR
--------------------------	------------------------------	--------------------------	---------------	---------------	-----

Raw material: PP, Volume range: 10 - 300 µl, Nominal volume: 300 µl, Matching rack: 770330

Item no.	Feature	Product colour	Box insert colour	Type of packaging	Sterile	Qty. inner / outer
776350	standard	<input type="radio"/> natural	<input checked="" type="radio"/> green	bag		1,000 / 10,000
776351	standard	<input type="radio"/> natural	<input checked="" type="radio"/> green	rack		960 / 5,760
776352	standard	<input type="radio"/> natural	<input checked="" type="radio"/> green	rack	+	960 / 5,760
776354	standard	<input type="radio"/> natural	<input checked="" type="radio"/> green	refill		960 / 4,800
776355	standard	<input type="radio"/> natural	<input checked="" type="radio"/> green	refill	+	960 / 4,800
776361	low retention	<input type="radio"/> natural	<input checked="" type="radio"/> green	rack		960 / 5,760
776362	low retention	<input type="radio"/> natural	<input checked="" type="radio"/> green	rack	+	960 / 5,760
776364	low retention	<input type="radio"/> natural	<input checked="" type="radio"/> green	refill		960 / 4,800
776365	low retention	<input type="radio"/> natural	<input checked="" type="radio"/> green	refill	+	960 / 4,800
776353	filter	<input type="radio"/> natural	<input checked="" type="radio"/> green	rack	+	960 / 5,760
776363	low retention filter	<input type="radio"/> natural	<input checked="" type="radio"/> green	rack	+	960 / 5,760



Pipette Tips

1000 µl

- / Universal fit for all common pipettes
- / Tips (without filter) and racks are autoclavable
- / Easy-to-read graduation
- / Colour-coded for tip identification



Raw material: PP, Volume range: 50 - 1.000 µl, Nominal volume: 1,000 µl, Matching rack: 770340

Item no.	Feature	Product colour	Box insert colour	Type of packaging	Sterile	Qty. inner / outer
777350	standard	○ natural	● blue	bag		1,000 / 5,000
777351	standard	○ natural	● blue	rack		960 / 3,840
777352	standard	○ natural	● blue	rack	+	960 / 3,840
777354	standard	○ natural	● blue	refill		960 / 4,800
777355	standard	○ natural	● blue	refill	+	960 / 4,800
777361	low retention	○ natural	● blue	rack		960 / 3,840
777362	low retention	○ natural	● blue	rack	+	960 / 3,840
777364	low retention	○ natural	● blue	refill		960 / 4,800
777365	low retention	○ natural	● blue	refill	+	960 / 4,800



Pipette Tips

1250 µl

- / Universal fit for all common pipettes
- / Tips (without filter) and racks are autoclavable
- / Easy-to-read graduation
- / Colour-coded for tip identification



Raw material: PP, Volume range: 50 - 1.250 µl, Nominal volume: 1,250 µl, Matching rack: 770340

Item no.	Feature	Product colour	Box insert colour	Type of packaging	Sterile	Qty. inner / outer
778350	standard	○ natural	● blue	bag		1,000 / 5,000

Item no.	Feature	Product colour	Box insert colour	Type of packaging	Sterile	Qty. inner / outer
778351	standard	○ natural	● blue	rack		960 / 3,840
778352	standard	○ natural	● blue	rack	+	960 / 3,840
778354	standard	○ natural	● blue	refill		960 / 4,800
778355	standard	○ natural	● blue	refill	+	960 / 4,800
778361	low retention	○ natural	● blue	rack		960 / 3,840
778362	low retention	○ natural	● blue	rack	+	960 / 3,840
778364	low retention	○ natural	● blue	refill		960 / 4,800
778365	low retention	○ natural	● blue	refill	+	960 / 4,800
778353	filter	○ natural	● blue	rack	+	960 / 3,840
778363	low retention filter	○ natural	● blue	rack	+	960 / 3,840



Racks (unfilled)

- / Highly transparent and stable
- / Can be autoclaved and reused up to 50 times
- / Stackable and automation-friendly
- / Colour-coded rack inserts for quick volume identification



FREE OF
detectable
DNase

FREE OF
detectable
human DNA

FREE OF
detectable
RNase

Item no.	Description	Feature	Box insert colour	Rack colour	Qty. inner / outer
770310	suitable for 10 µl / 10 µl ext.		● red	○ natural	10 / 60
770320	suitable for 200 µl		● yellow	○ natural	10 / 60
770330	suitable for 300 µl		● green	○ natural	10 / 60
770340	suitable for 1000 µl / 1250 µl		● blue	○ natural	10 / 40
770370	suitable for 10 - 300 µl	without rack insert		○ natural	10 / 60
770380	suitable for 1000 - 1250 µl	without rack insert		○ natural	10 / 40

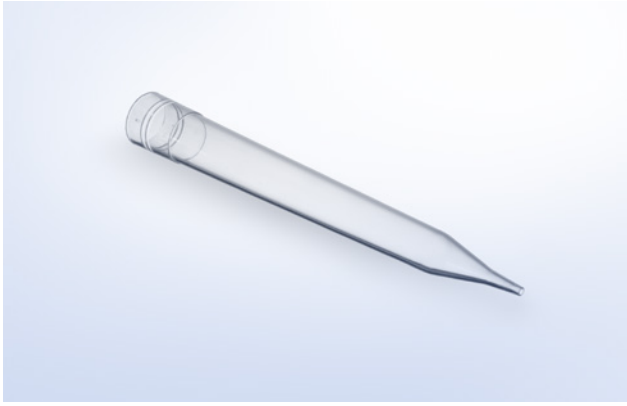

Macro Pipette Tip

1-5 ml

- / Volume range from 1 - 5 ml
- / Suitable for Gilson® P5000

Feature: Macro, Graduation: -, Volume range: 1 - 5 ml

Item no.	Product colour	Qty. inner / outer
745290	○ natural	250 / 2,500



- / Serological pipettes are also available triple-packed.



CELLSTAR® SEROLOGICAL PIPETTES

- / Tip design guarantees drop-free pipetting
- / Maximum accuracy
- / High optical clarity
- / Clear, easy to read graduation
- / A coloured vertical Schellbach stripe on 1, 2, 5, 10 and 25 ml pipettes makes it considerably easier to read off the volume
- / Colour code according to international standards

Greiner Bio-One offers a wide range of different serological pipettes and transfer pipettes.

The volume capacity of the serological pipettes is increased by a negative graduation. The pipettes are provided with colour codes according to international standards. The use of high-grade polystyrene guarantees maximum clarity. Expiry date and LOT number are printed on

each single packaging unit. All pipettes are supplied with a filter for protection against the suction of liquid into the pipetting device.

CELLSTAR® serological pipettes are available in three different packaging options: in plastic bulk packs as well as individually wrapped in plastic or paper/plastic, both with peel-off function and additional break-through function.



Serological Pipettes

- / Sterile
- / Increased volume range with negative graduations
- / Lot number and expiry date on each bag
- / Filter for protection against suction of liquids into the pipetting device
- / Various packaging options

STERILE

FREE OF
detectable
DNase

FREE OF
detectable
human DNA

FREE OF
detectable
RNase

 non-
cytotoxic

 non-
pyrogenic

Raw material: PS, Sterile: +

Item no.	Description	Graduation	Nominal volume	Packaging	Type of packaging	Sterile	Qty. inner / outer
604107	1 ml pipette	1/100	1 ml		bulk	+	25 / 1,000
604160	1 ml pipette	1/100	1 ml	plastic / plastic	single-packed	+	100 / 1,000
604181	1 ml pipette	1/100	1 ml	paper / plastic	single-packed	+	100 / 1,000
710107	2 ml pipette	1/100	2 ml		bulk	+	25 / 1,000
710160	2 ml pipette	1/100	2 ml	plastic / plastic	single-packed	+	100 / 1,000
710180	2 ml pipette	1/100	2 ml	paper / plastic	single-packed	+	100 / 1,000
606107	5 ml pipette	1/10	5 ml		bulk	+	25 / 500
606160	5 ml pipette	1/10	5 ml	plastic / plastic	single-packed	+	50 / 200
606180	5 ml pipette	1/10	5 ml	paper / plastic	single-packed	+	50 / 200
607107	10 ml pipette	1/10	10 ml		bulk	+	25 / 500
607160	10 ml pipette	1/10	10 ml	plastic / plastic	single-packed	+	50 / 200
607180	10 ml pipette	1/10	10 ml	paper / plastic	single-packed	+	50 / 200
760107	25 ml pipette	2/10	25 ml		bulk	+	25 / 200
760160	25 ml pipette	2/10	25 ml	plastic / plastic	single-packed	+	50 / 200
760180	25 ml pipette	2/10	25 ml	paper / plastic	single-packed	+	50 / 200
768160	50 ml pipette	1/2	50 ml	plastic / plastic	single-packed	+	20 / 100
768180	50 ml pipette	1/2	50 ml	paper / plastic	single-packed	+	20 / 100



Serological Pipettes

Triple-packed

- / Sterile
- / Increased volume range with negative graduations
- / Lot number and expiry date on each bag
- / Filter for protection against suction of liquids into the pipetting device
- / Triple-packed

STERILE	FREE OF detectable DNase	FREE OF detectable human DNA	FREE OF detectable RNase	non-cytotoxic	non-pyrogenic
---------	--------------------------	------------------------------	--------------------------	---------------	---------------

Raw material: PS, Packaging: plastic / plastic, Triple-packed: yes, Sterile: +

Item no.	Description	Graduation	Nominal volume	Sterile	Qty. inner / outer
604160-TRI	1 ml pipette	1/100	1 ml	+	10 / 100
710160-TRI	2 ml pipette	1/100	2 ml	+	10 / 100
606160-TRI	5 ml pipette	1/10	5 ml	+	10 / 100
607160-TRI	10 ml pipette	1/10	10 ml	+	10 / 100
760160-TRI	25 ml pipette	2/10	25 ml	+	10 / 100
768160-TRI	50 ml pipette	1/2	50 ml	+	10 / 100

Serological Pipettes

Special Models



- / Short-format pipettes (shorties) permit back-saving work
- / 2 ml aspiration pipette without plug and graduation
- / Single-packed

STERILE	FREE OF detectable DNase	FREE OF detectable human DNA	FREE OF detectable RNase	non-cytotoxic	non-pyrogenic
---------	--------------------------	------------------------------	--------------------------	---------------	---------------

Raw material: PS, Sterile: +

Item no.	Description	Feature	Graduation	Nominal volume	Packaging	Sterile	Qty. inner / outer
710183	2 ml aspiration pipette	no plug	-	2 ml	paper / plastic	+	100 / 1,000
606190	5 ml pipette	shorty	1/10	5 ml	plastic / plastic	+	50 / 200
607190	10 ml pipette	shorty	2/10	10 ml	plastic / plastic	+	50 / 200



MaxiPette

- / Ergonomic design for easy pipetting
- / Variable speed control
- / Cordless and rechargeable
- / Up to eight hours of continuous operation
- / Compatible with Greiner Bio-One serological pipettes

Description: MaxiPette, Content kit: pipette controller charger benchtop stand extra filter replaceable lithium battery

Item no.	Qty. inner / outer
847060	1 / 1

/ Device with US or UK plug available on request



Pasteur / Serum Pipettes

- / Ideally suited for the rapid transfer of liquids
- / Sterile / non-sterile

Length: 153 mm

Item no.	Description	Graduation	Working volume	Sterile	Qty. inner / outer
700370	pasteur pipette	-	≤0,1 ml		500 / 1,500
700361	pasteur pipette	-	≤0,1 ml	+	25 / 1,000
612301	serum pipette	yes	≤2,5 ml		500 / 1,500
612361	serum pipette	yes	≤2,5 ml	+	1 / 800
612362	serum pipette	yes	≤2,5 ml	+	25 / 1,000

Pasteur / Serum Pipettes

- / Ideally suited for the rapid transfer of liquids
- / Available Sterile or Non-Sterile

Graduation: yes

Item no.	Qty. inner / outer
612381	20 / 500
612302	3,000 / 3,000
612398	- / 500
612382	20 / 500
612399	- / 500



The Greiner Bio-One portfolio includes small laboratory equipment to match the consumables such as PCR tubes, plates and tubes, in order to provide our customers with comprehensive service, compatibility and highest quality: Mini-centrifuges, Vortex Mixers, Block Heaters, Microplate Centrifuges and ergonomic pipettes are used for modern handling in everyday laboratory work. All from one source - for highest quality requirements.

LAB EQUIPMENT

/ Lab Equipment	248
Mini Centrifuge	249
Microplate Centrifuge	249
Mini Vortex Mixer	250
Vortex Mixer	250
Mini Block Heater	251
Inserts for Mini Block Heater	251



- / For Sapphire MaxiPette pipette controller please refer to chapter Liquid Handling
- / For further information, please refer to our website: www.gbo.com

LAB EQUIPMENT

Greiner Bio-One, a leading provider of labware, completes its product portfolio by compatible lab equipment.

Mini centrifuges are ideal for quick spin-downs of microtubes and PCR tubes. Braking system is activated when the lid is opened, smoothly decelerating to a complete stop in just one second.

The microplate centrifuge allows centrifugation of two plates, even without a lid or seal.

Our mini vortex mixer can vortex even the largest samples instantly with its 4 mm orbit and speed of 2800 rpm. Despite its powerful motor, it has a size smaller than 10 x 10 cm, allowing it to fit on even the most crowded bench.

The Mini Block Heater is the perfect tool for laboratory incubations, with its compact construction, broad temperature range and multiple block options.

- / Centrifuges
- / Vortex Mixer
- / Mini Block Heater



Mini Centrifuge

- / Ideal for quick spin-downs of microtubes and PCR tubes
- / Rotor instantly reaches 6,000 rpm
- / Storage compartment for PCR tube rotor
- / Decelerates in just one second
- / Compatible with all Greiner Bio-One PCR and reaction tubes

Feature: capacity 8 x 1.5 / 2.0 ml tubes, 4 x PCR strips (8 x 0.2 ml), 32 x 0.2 ml PCR tubes, Height: 11.4 cm, Length: 11.4 cm, Width: 15 cm, Speed: 6,000 RPM, Operating temperature: 4 - 45 °C, Max. radius: 4.9 cm

Item no.	Plug	Qty. inner / outer
843060	UK	1 / 1



Microplate Centrifuge

- / Rapid spin-down of microplates with 2,550 rpm
- / Unique rotor design holds two plates without spillage
- / 50 % smaller than traditional centrifuges
- / Compatible with most Greiner Bio-One microplates

Description: Microplate Centrifuge, Feature: capacity x 96 well microplates, 2 x 96 well PCR microplates, Height: 19.7 cm, Length: 23 cm, Width: 26 cm, Speed: 2,550 RPM, Operating temperature: 4 - 45 °C, Max. radius: 8 cm

Item no.	Plug	Qty. inner / outer
846060	UK	1 / 1

/ Device with US or UK plug available on request



Mini Vortex Mixer

- / Powerful, quiet vortexing for tubes up to 50 ml
- / Instant pressure-activated operation
- / Compact, fits in the palm of your hand
- / Compatible with all Greiner Bio-One tubes

Description: Mini Vortex Mixer, Feature: head: Standard rubber lid for mixing single tubes, Height: 6.6 cm, Length: 9.4 cm, Width: 9.9 cm, Mode: TOUCH Mix, Orbit: 4 mm, Operating temperature: 4 - 45 °C

Item no.	Plug	Qty. inner / outer
845060	UK	1 / 1

/ Device with US or UK plug available on request



Vortex Mixer

- / Powerful motor for instant vortexing of up to 50 ml tubes
- / Dynamic balance system to minimise noise and vibration
- / Touch or continuous operation
- / Variable speed control from 200 to 3,200 rpm
- / Compatible with all Greiner Bio-One tubes

Description: Vortex Mixer, Feature: head: standard rubber cap single tube, base with four suction cups, Height: 17 cm, Length: 13 cm, Width: 16 cm, Mode: ON (continuous), OFF and TOUCH mix, Orbit: 3 mm, Operating temperature: 4 - 45 °C

Item no.	Plug	Qty. inner / outer
844060	UK	1 / 1

/ Device with US or UK plug available on request

Mini Block Heater



- / Simple touchpad operation
- / Easy-to-read digital display
- / Compact, fits in the palm of your hand
- / Exchangeable blocks for tubes from 0.2 to 50 ml

Description: Mini block heater (without insert), block options, high-grade aluminium, Feature: ambient temperature from 5 - 100 °C, Height: 10 cm, Length: 11.2 cm, Width: 15 cm, Temperature increments: +/- 0.5 °C, Temperature uniformity: 0.2 °C, Temperature incements: 0.1 °C, Operating temperature: 4 - 45 °C

Item no.	Plug	Qty. inner / outer
848060	UK	- /1

/ Device with US or UK plug available on request

Inserts for Mini Block Heater

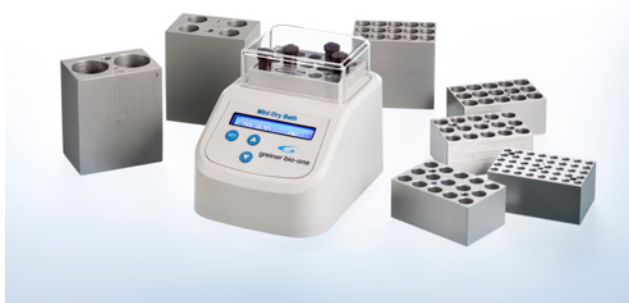

- / Exchangeable blocks for tubes from 0.2 to 50 ml

Item no.	Feature	Qty. inner / outer
848916	suitable for 15 pcs. 1.5 ml reaction tube, 0.5 ml PCR tube	- /1
848923	suitable for 15 pcs. 1.5 / 2 ml reaction tube, 0.5 ml PCR tube	- /1
848902	suitable for 40 pcs. 0.2 ml PCR tube, PCR 8-tube strip	- /1
848913	suitable for 15 pcs. 4 / 5 ml Cryo.s, 4.5 / 5 / 7 ml tube	- /1
848921	suitable for 15 pcs. 1 / 2 ml Cryo.s, 4 ml tube	1 / 1
848915	suitable for 4 pcs. 15 ml conical tube, 12 / 14 / 20 ml tube	1 / 1
848950	suitable for 2 pcs. 50 ml conical tube	1 / 1



DIN EN ISO 9001 Certification

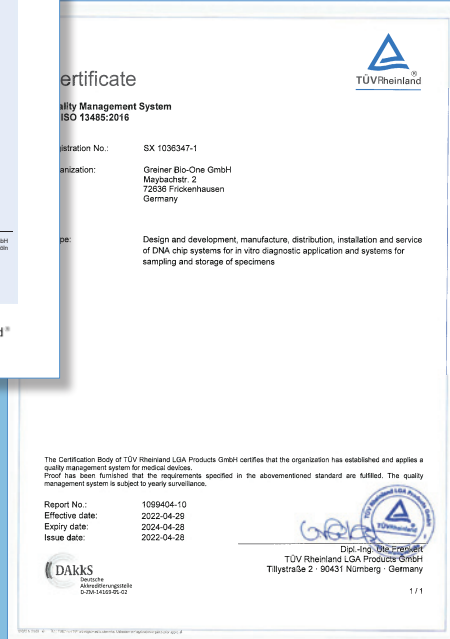

EN ISO 13485 Certification



DIN EN ISO 50001 Certification

QUALITY STANDARDS AT GREINER BIO ONE

Greiner Bio-One is certified according to the international standards DIN EN ISO 9001 and EN ISO 13485 for Medical Devices. Since 2013,

Greiner Bio-One Frickenhausen (Germany) is also certified according to DIN EN ISO 50001 (systematic energy management).

TECHNICAL APPENDIX

/ General Information for the Lab254	/ Laboratory Information for Centrifugation 274
Chemical Resistance of Various Materials254	Centrifugation - Principle and Calculation of the RCF 274
Chemical Resistance of Various Materials255	(Relative Centrifugal Force) 274
Chemical Resistance of Cycloolefins (COC / COP)256	Alignment Chart276
Chemical Resistance of Polyethylene Terephthalate (PET) 257	Maximal Centrifuge Capacity of Tubes,276
Capillary Pore Membranes (ThinCert® Cell Culture Inserts)..... 257	Reaction Tubes and Microplates276
Chemical Resistance of Sealers258	Reaction Tubes.....276
Temperature Stability of Sealers258	Polystyrene Tubes277
Physical Properties of Various Materials.....259	Polyethylene Tubes.....278
Manual Calculation260	Multiwell Plates.....278
Overview Metric Prefixes 261	Microplates.....278
/ Laboratory Information for Microplates.... 262	Microplates.....279
Well Profiles of 96 Well Microplates262	PCR Plates.....279
Well Profiles of 96 Well ELISA Strip Plates264	/ Laboratory Information for Cryo.s Sample Storage280
/ Laboratory Information for Liquid Handling 266	Freezing Protocol280
Compatibility for SAPPHIRE Pipette Tips and Pipettes.....266	Thawing Protocol..... 281
/ Laboratory Information for PCR270	/ Laboratory Information for Immunology... 282
Overview PCR Microplates270	Volume-Dependent Wetting of Immunological Products.....282
Compatibility for PCR Microplates272	/ Glossary284
Compatibility for Mini Block Heater Inserts....274	

GENERAL INFORMATION FOR THE LAB

CHEMICAL RESISTANCE OF VARIOUS MATERIALS

	PS 20°C	PS 50°C	PP 20°C	PP 50°C	HDPE 20°C	HDPE 50°C	LDPE 20°C	LDPE 50°C	PC 20°C	PC 50°C
Acetic acid 10 %	1	1	1	1	1	1	1	1	1	2
Acetic acid 50 %	2	2	1	1	1	1	1	1	1	2
Acetic acid 90 %	4	4	1	2	1	1	1	2	4	4
Acetone	4	4	1	3	1	1	3	3	4	4
Acetonitrile	4	4	3	4	1	1	1	1	4	4
Ammonia 25 %	2	2	1	1	1	1	1	1	4	4
Ammonium acetate	1	1	1	1	1	1	1	1	1	1
Amyl alcohol	1	1	1	1	1	1	1	2	1	
Ascorbic acid			1	1	1		1		2	2
Benzene	4	4	4	4	4	4	4	4	4	4
Benzyl alcohol	4	4	4	4	3	4	4	4	4	4
Boric acid 10 %	1	1	1	1	1	1	1	1	1	1
Carbon tetrachloride	4	4	4	4	3	4	4	4	4	4
Carbonic acid	1	1	1	1	1	3	1	1	1	
Chloroform 100 %	4	4	3	4	3		3		4	4
Citric acid 10 %	1	1	1	1	1	1	1	1	1	2
Cyclohexanol	3	3	1	3	1	1	1	1	3	
Detergents			1	1						
Dichloroacetic acid			1	1	1	1			4	4
Diethyl ether	4	4	4	4	3	4	4	4	4	4
Dimethyl acetamide	4	4	1	1	1	1	3	4		
Dimethylsulfox. (DMSO)	1	2	1	1	1	1	1	1	4	4
Emulsifier			1	1						
Ethanol 50 %	1	1	1		1	1	1	2	1	1
Ethanol 96 %	1	1	1	1	1		1		1	3
Ether	4	4	4	4	3	4	4	4	4	4
Formaldehyde 10 %	3	4	1	1	1	1	1	1	1	2
Formaldehyde 40 %	4	4	1	2	1	2	2	3	1	2
Formamide	1	1	1	1	1	1	1	1	3	3
Formic acid 50 %	3	3	1	2	1	1	1	2	3	3
Glucose	1	1	1	1	1	1	1	1	1	1
Glycerine	1	1	1	1	1	1	1	1	3	3
Heptane	4	4	3	3	2	3	3	4	1	2
Hexanol			1		1		1		2	2
Hydrochloric acid 20 %	1	1	1	1	1	1	1	1	2	3
Hydrochloric acid conc.	3	3	1	1	1	1	1	1	4	4
Hydrogen peroxide 3 %	1	1	1	1	1	1	1	1	3	3
Hydroquinone	4	4	1				1	3	3	3
Isoamyl alcohol	1	1							3	0
Isobutanol	2	2	1	1	1	1	1	1	1	2
Isopropanol	2	2	1	1	1	1	1	1	1	2
Isopropyl acetate	4	4	2	3	1	2	2	3	4	4
Isopropyl benzene	4	4	3	4	2	3	3	4	4	4
Isopropyl ether	4	4	4	4	4	4	4	4	4	4
Lactic acid 3 %	2	2	1	2	1	1	1	2	1	2
Lactic acid 85 %	2	2	1	2	1	1	1	1	1	2
Liquid paraffin	1	1	1	3	1	1	1	3	1	

CHEMICAL RESISTANCE OF VARIOUS MATERIALS

	PS 20°C	PS 50°C	PP 20°C	PP 50°C	HDPE 20°C	HDPE 50°C	LDPE 20°C	LDPE 50°C	PC 20°C	PC 50°C
Methanol	3	4	1	1	1	1	1	1	4	4
Methyl acetate	4	4	2	3	3	3	3	4	4	4
Methyl phenyl ether 100 %	4	4	3				3		4	4
Methyl propyl ketone	4	4	2	3	1	2	2	3	4	4
Methylamine 32 %			1		1		1		4	4
Methylene chloride	4	4	3	4	4	4	4	4	4	4
Naphthalene			1		1	3			3	3
Nitrobenzene	4	4	4	4	3	4	4	4	4	4
Oxalic acid	1	1	1	1	1	1	1	1	3	4
Ozone	3	3	1	2	1	1	1	2	1	2
Palmitic acid	1	1	3	4	3		2		2	2
Phenol 10 %	4	4	1	1	1	1	1	1	4	4
Phenol 100 %	4	4	1	1	2	3	3	3	4	4
Phosphoric acid 1 – 5 %	2	2	1	1	1	1	1	1	1	1
Phosphoric acid 85 %	1	1	1	2	1	1	1	1	1	2
Phthalic acid	1	1	1	1	1	1	1	1	3	3
Potassium carbonate	1	1	1	1	1	1	1	1	3	3
Potassium chromate	1	1	1	1	1	1	1		2	2
Potass. permanganate	2	3	1	1	1	1	1	1	1	
Propanol	3	3	1	1	1	1	1	1	1	
Sodium acetate	2	2	1	1	1	1	1	1	1	2
Sodium chloride	1	1	1	1	1	1	1	1	1	1
Sodium hydroxide 30 %	1	1	1	1	1	1	1	1	4	4
Sodium hydroxide 45 %	1	1	1	1	1	1	1	1	4	4
Sodium hydroxide 60 %	1	1	1	1					4	4
Sodium hypochloride	1	1	2	3	2	3	2	3	2	3
Sodium permanganate	2	3	1	1	1	1	1	1		
Sodium thiosulfate	1	1	1	1	1	1	1	1	2	2
Stearic acid	1	2	1	1	1	1	1	1	1	2
Sulphuric acid 1 – 6 %	1	2	1	1	1	1	1	1	1	1
Sulphuric acid 60 %	2	4	1	3	1	3	1	3	3	3
Sulphuric acid conc.	4	4	4	4	4	4	4	4	4	4
Tannin acid	1	1	1	1					3	3
Terpentine oil					3	4	3	4	4	4
Tetrahydrofuran	4	4	3	4	3	4	4	4	4	4
Toluene	4	4	3	4	3	4	3	4	4	4
Trichloroacetic acid	4	4	3	4	3	3	3	4	4	4
Urea	1	2	1	1	1	1	1	1	1	1
Uric acid			1		1		1		1	
Urine	3	3	1	1	1	1	1	1	1	
Xylene	4	4	4	4	2	3	2	4	4	4

1 = resistant 2 = limited resistant 3 = moderate resistant 4 = no resistance

These tables are a general guide only. As many factors can affect the chemical resistance of a given product, its suitability for a specific application should be tested.

CHEMICAL RESISTANCE OF CYCLOOLEFINS (COC / COP)

Cycloolefin		Cycloolefin		Cycloolefin	
Acetic acid 99 %	1	Dibutyl ether	4	Isopropanol	1
Acetone	1	Dichloroethane	4	Methanol	1
Acrylonitrile	1	Dichloromethane	4	Methylene chloride	4
Ammonia 33 %	1	Diethyl ether	4	Nitric acid (HNO ₃)	1
Benzaldehyde	3	Dimethyl sulfoxide	1	Octane	4
Benzene	4	DMSO	1	Pentane	4
Benzine	4	Ethanol 50 %	1	Sodium hydrox. (NaOH) 50 %	1
Butanon	1	Ethanol 96 %	1	Sulphuric acid (H ₂ SO ₄) 40 %	1
Carbon tetrachloride	4	Fatty acid	4	Sulphuric acid (H ₂ SO ₄) 95 %	1
Chloroform	4	Heptane (n-Heptane)	4	Toluene	4
Cyclohexane	4	Hexane	4	Xylene	4
Cyclohexanone	4	Hydrochloric acid (HCl) 36 %	1		
Detergents	1	Hydrogen peroxide water 30 %	1		

1 = resistant 2 = limited resistant 3 = moderate resistant 4 = no resistance

This table is a general guide only. As many factors can affect the chemical resistance of a given product, its suitability for a specific application should be tested.

CHEMICAL RESISTANCE OF POLYETHYLENE TEREPHTHALATE (PET) CAPILLARY PORE MEMBRANES (THINCERT® CELL CULTURE INSERTS)

PET		PET		PET	
Acetaldehyde	1	Ethanol	1	Monochlorbenzene	1
Acetic acid (10 %)	1	Ethyl acetate	1	Nitric acid (30 %)	1
Acetic acid (100 %)	3	Ethyl ether	1	Nitrobenzene	1
Acetone	1	Ethylendichloride	1	Nitropropane	1
Ammonium hydroxide (5 %)	1	Ethylene glycol	1	n-Propanol	1
Amyl acetate	1	Fluoric acid (35 %)	1	Pentane	1
Amyl alcohol	1	Formaldehyde	1	Perchlorethylene	1
Aniline	1	Formic acid (50 %)	1	Petroleum ether	1
Benzene	3	Freon	1	Phosphoric acid (85 %)	3
Benzyl alcohol	1	Glutaraldehyde	1	Potassium hydroxide	4
Benzyl benzoate	1	Glycerol	1	Propyl acetate	1
Boric acid (5 %)	1	H ₂ O ₂ (30 %)	1	Pyridine	1
Butanol	1	Halogenated phenoles	4	Silicon oil	1
Butyl acetate	1	Hexane	1	Sodium hydroxide	4
Butyl cellulose	1	Hydrochloric acid (20 %)	1	Sulphuric acid (25 %)	1
Carbon tetrachloride	1	i-Propanol	1	Terpentine oil	1
Chloroform	1	Isopropyl myristate	1	Tetrahydrofurane	1
Concentrated strong acids	4	Methanol	1	Tetraline	1
Cyclohexane	1	Methyl acetate	1	Toluene	3
Cyclohexanone	3	Methyl cellulose	1	Trichlorbenzene	1
Dekaline	1	Methylenchloride	3	Trichlorethylene	1
Dimethylacetamide	1	Methylethylketone	1	Triethanolamin	1
Dimethylformamide	1	Methylglycol acetate	1	Trikresyl phosphate	1
Dimethylsulfoxide	1	Methylisobutylketone	1	Xylene	3
Dioxane	1	Mineral oils	1		

For the solvents effecting slight changes the user should test the compatibility under the specific application conditions. All tests have been performed at RT. Please be aware that ThinCert® cell culture inserts are made of PET membranes sealed on polystyrene housings. Therefore, solvents shown compatible with PET membranes in the above table might be incompatible with the polystyrene housing. Please check solvent compatibility with polystyrene.

Resistance scale from 1 to 4

1 = resistant	i.e. the plastics may be treated with the chemical compound at mentioned temperature over several years without any significant alterations in its physical, optical and chemical properties
2 = limited resistant	i.e. the plastics may be treated with the chemical compound at mentioned temperature over several weeks without any significant alterations in its physical, optical and chemical properties
3 = moderate resistant	i.e. the plastics may be treated with the chemical compound at mentioned temperature for short time only (several minutes to one hour) without any alterations in physical, optical and chemical properties (mixing and measuring is possible)
4 = no resistance	i.e. treating the plastics with the substance named may cause alterations in physical, optical and chemical properties within seconds

CHEMICAL RESISTANCE OF SEALERS

	EASYseal (Art. No. 676001)	VIEWseal (Art. No. 676070)	AMPLiseal (Art. No. 676040)	SILVERseal (Art. No. 676090)
Acetone	4	4	4	3
Acetonitrile	3	3	4	1
Acetic acid 1 %	3	1	4	3
Glacial acetic acid	1	3	4	3
Chloroform	4	4	4	4
DMSO	3	3	3	1
Ethanol	3	1	1	1
Hydrochloric acid 32 %	3	1	3	4
Isopropanol	3	1	1	1
Methanol	3	1	4	1
Phenol	3	3	4	3
Sulphuric acid 0.5 M	1	1	1	1

1 = Stable
 3 = Moderately stable
 4 = Unstable

no visible change in the sealer after one week's incubation
 after one week, optical and physical changes in the sealer (clouding tears on removal)
 adhesive and foil are dissolved, wells not leak-tight

This table can only be used as an orientation aid for the suitability of the respective sealers, since their behaviour against chemicals depends on the respective application. Tests under practical conditions are absolutely essential in many cases.

TEMPERATURE STABILITY OF SEALERS

	Temperature Stability
EASYseal	-40 °C to + 120 °C
VIEWseal	-70 °C to + 100 °C
AMPLiseal	-80 °C to + 110 °C
SILVERseal	-70 °C to + 100 °C
BREATHseal	n.a. / Evaporation rate 4200 g H ₂ O/m ² in 24 h

This table can basically be used as an orientation aid for the temperature stability of the respective sealers, since the behaviour of the product depends on the respective application. Tests under practical conditions are absolutely essential in many cases.

PHYSICAL PROPERTIES OF VARIOUS MATERIALS

Material	Sterilisation by				Auto-clavability	Thermal Stability [°C]	Transparency	Gas Permeability ²			WVTR ³
	gamma irradiation	chemicals (formalin, ethanol)	dry heat	gas ¹				O ₂	N ₂	CO ₂	
Polystyrene	•	•		•		-20 to +60	clear	4.7	853	17.8	108 - 155
Polypropylene	•	•		•	•	-196 to +121	translucent	3.7	744	12.4	3.9
HDPE	•	•		•		-50 to +100	translucent	2.9	651	9	4.6 - 6.2
LDPE	•	•		•		-50 to +80	translucent	7.8	2.8	41.9	15.5 - 23.3
UV-Star®	•			•		-20 to +40	clear				
PETG	•	•		•		-40 to +60	clear	388	155	1.2	62
PET	•	some		•		-40 to +60	clear	46.5	10.9	236	15 - 20
Cycloolefin	•			•		-80 to +100	clear				

Exemptions are mentioned in the respective product data sheets.

¹ Ethylene oxide, formaldehyde

² [cc x mm/m² x 24 h x Bar]

³ at 37°C, 90 % humidity [g x mm/m² x 24 h x Bar]

Material	Refractive Index
Polystyrene	1.59
UV-Star®	1.53
Cycloolefin	1.53
Glass	1.53

These tables are a general guide only. As many factors can affect the resistance of a given product, its suitability for a specific application should be tested.

MANUAL CALCULATION

COEFFICIENT OF VARIATION (CV)

The coefficient of variation compares the variability of several random samples with different means, taking into account the different dimensions of means:

$$CV \% = \frac{S}{|\bar{X}|} \cdot 100 \%$$

/ where S is the standard deviation and $|\bar{X}|$ is the absolute value of the arithmetic mean.

VOLUME OF DIVERSE BODIES

VOLUME OF A CYLINDER:

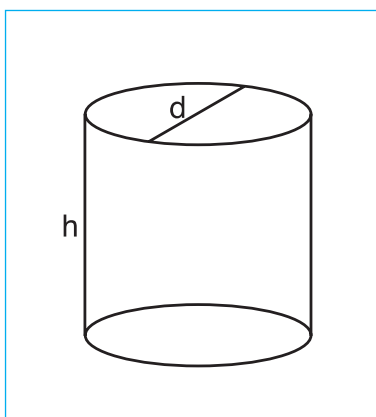

$$V = \frac{\pi \cdot d^2 \cdot h}{4}$$

$$h = \frac{4 \cdot V}{\pi}$$

/ This formula can be used for calculating the filling level in relation to the filling volume in a 96 well microplate with cylindrical wells.

VOLUME OF A CUBOID:

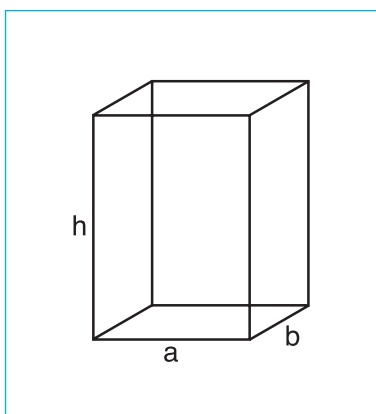

$$V = a \cdot b \cdot h$$

$$h = \frac{V}{a \cdot b}$$

/ This formula can be used for calculating the filling level in relation to the filling volume in 384 and 1536 well microplates with rectangular wells.

OVERVIEW METRIC PREFIXES

G	= giga	= 10^9
M	= mega	= 10^6
k	= kilo	= 10^3
c	= centi	= 10^{-2}
m	= milli	= 10^{-3}
μ	= micro	= 10^{-6}
n	= nano	= 10^{-9}
p	= pico	= 10^{-12}
f	= femto	= 10^{-15}
a	= atto	= 10^{-18}
z	= zepto	= 10^{-21}

LABORATORY INFORMATION FOR MICROPLATES

WELL PROFILES OF 96 WELL MICROPLATES

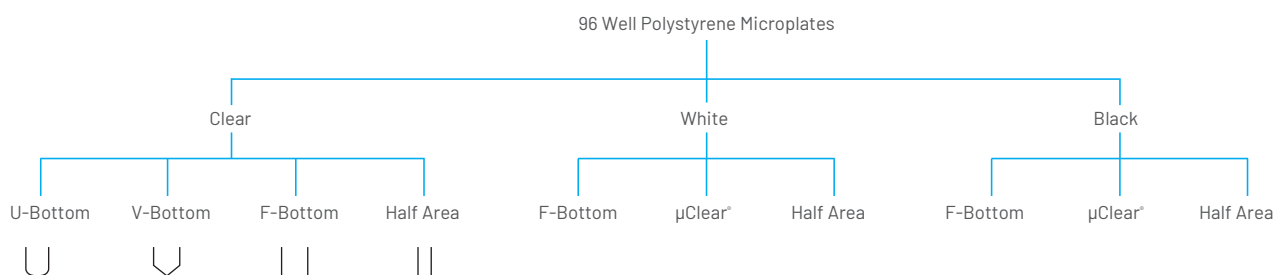

WELL PROFILE

The well profile is a critical aspect in a 96 well microplate. Different well shapes are available for each application (Fig. 1 – Fig. 4):

U-BOTTOM

The “U” describes the round bottom shape (Fig. 1). U-bottom microplates are ideally suited for agglutination tests.

- / No sharp corners to facilitate easy and residue-free pipetting
- / Suitable for +/- analyses

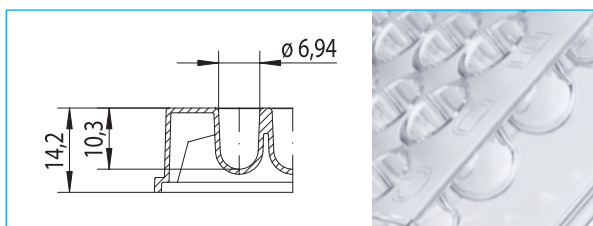

Figure 1:
Well profile: 96 well U-bottom, polystyrene
Total volume: 323 µl
Working volume: 40 – 280 µl

V-BOTTOM

The “V” stands for the conically tapered well bottom (Fig. 2). These microplates are ideally suited for applications in which the entire sample volume must be pipetted off.

- / For precise pipetting
- / Ideally suited for the storage of samples
- / Suitable for +/- analyses

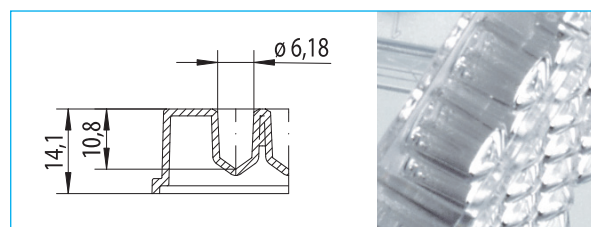

Figure 2:
Well profile: 96 well V-bottom, polystyrene
Total volume: 234 µl
Working volume: 40 – 200 µl

F-BOTTOM/STANDARD (ST)

The "F" refers to the flat well bottom (Fig. 3). This well type is ideal for precise optical measurements. The measuring light source is not deflected by the well profile.

- / Excellent optical properties
- / For precise optical measurements
- / For microscopic applications (bottom reading)

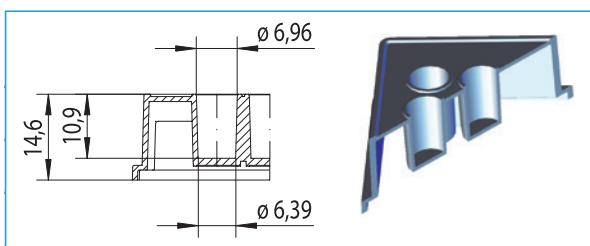

Figure 3:
Well profile: 96 well F-bottom / ST, polystyrene
Total volume: 382 μ l
Working volume: 25–340 μ l
Growth area: 32 mm²

HALF AREA

Half Area microplates (Fig. 5) offer an interesting alternative to conventional 96 well microplates. They can be pipetted manually without any problem but at the same time allow a reduction of the sample volume by up to 50 %.

- / Reduction of sample volume of up to 50 %
- / Standardised pathlength (1 cm=170 μ l, 0.5 cm=80 μ l)

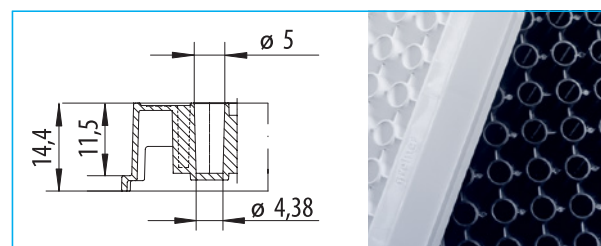

Figure 5:
Well profile: 96 well Half Area
Total volume: 199 μ l
Working volume: 15–175 μ l
Growth area: 15 mm²

F-BOTTOM/CHIMNEY WELL

The standard flat bottom microplate (Fig. 3) has the same well profile as the chimney well microplate (Fig. 4). The difference from the standard plate is the chimney-like arrangement of the wells. Each well stands on its own. Therefore the risk of sample carryover and cross contamination is minimised.

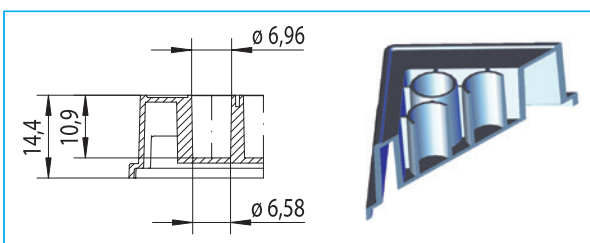
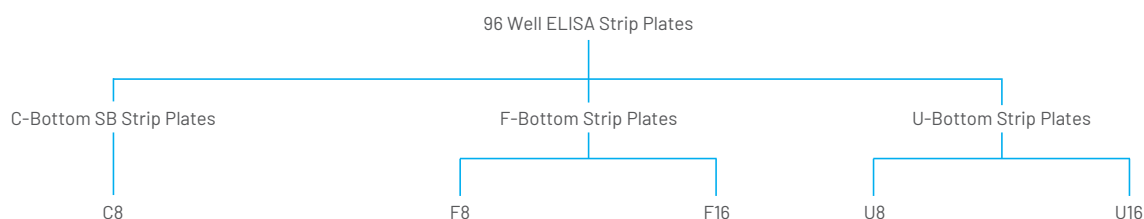

Figure 4:
Well profile: 96 well F-bottom / chimney well, polystyrene
Total volume: 392 μ l
Working volume: 25–340 μ l
Growth area: 34 mm²

WELL PROFILES OF 96 WELL ELISA STRIP PLATES



WELL PROFILE

Microplates in strip format offer the advantage of greater flexibility in diagnostics. Individual strips can be removed from the support frame so that the number of tests to be performed can be adjusted to the number of samples, and is not predetermined by the microplate format used. In addition, the individual strips of a microplate can be subjected to a wide variety of different test conditions.

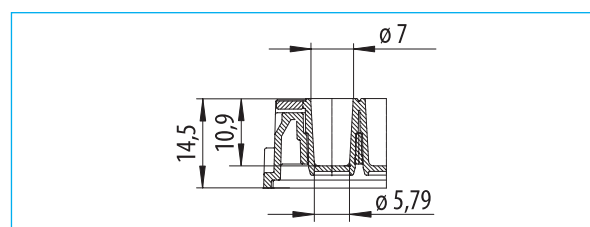

Figure 1:
 Well profile: C-bottom
 Total volume: 346 μ l
 Working volume: 20–300 μ l

C-BOTTOM SB (SINGLE-BREAK) STRIP PLATES

The “C” describes a flat-bottom profile with rounded corners (Fig. 1). The rounded corners mean that the individual wells can be pipetted without leaving a residue, and the flat bottom still enables precise optical measurements. C-bottom SB strips are supplied as twelve 8 well strips, in a support frame with 96 spaces (12 x 8 matrix). The individual wells can be broken off separately (“single-break” option) and the number of tests performed can thus be precisely adjusted to the number of samples. C-bottom SB strip plates are available in clear polystyrene and additionally with a red, green, blue or yellow colour coding on the well rim.

U-BOTTOM STRIP PLATES

96 well strip plates with a round bottom (U-bottom, Fig. 2) are available as both 8 well and 16 well strips. The "U" describes the round bottom form. U-bottom strip plates are ideally suited for agglutination tests.

- / No corners, therefore simple and clean pipetting
- / Suitable for +/- analyses

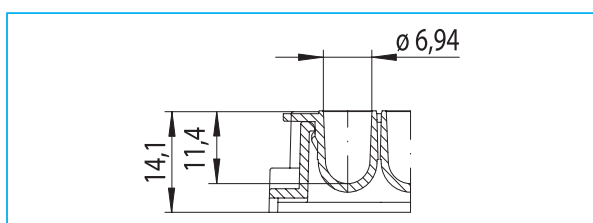

Figure 2:
Well profile: U-bottom
Total volume: 312 μ l
Working volume: 50-280 μ l

F-BOTTOM STRIP PLATES

96 well strip plates with a flat bottom (F-bottom, Fig. 3) are available as 8 well strips and as 16 well strips. The "F" stands for the flat bottom of the wells. This well type is ideal for the most precise optical measurements as the measuring light beam is not deflected by the well profile. F-bottom strip plates are available in clear polystyrene (MICROLON) and additionally in black (FLUOTRAC) and white (LUMITRAC).

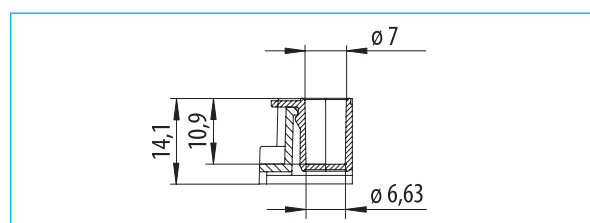

Figure 3:
Well profile: F-bottom
Total volume: 388 μ l
Working volume: 20-350 μ l

LABORATORY INFORMATION FOR LIQUID HANDLING

COMPATIBILITY FOR SAPPHIRE PIPETTE TIPS AND PIPETTES

	PIPETTE TIPS (STANDARD / LOW RETENTION)							
Volume [µl]	10	10 extended	20	100	200	300	1000	1250
Volume range [µl]	0.2-10	0.5-10	2-20	2-100	5-200	10-300	50-1000	50-1250
Tip version	Tip/ Filter tip	Tip/ Filter tip	Filter tip	Filter tip	Tip/ Filter tip	Tip/ Filter tip	Tip	Tip/ Filter tip
Article no.	7713XX	7723XX	7733XX	7743XX	7753XX	7763XX	7773XX	7783XX

PIPETTE MODELS

GREINER BIO-ONE

		Single-channel pipettes							
Sapphire	0.2-2 µl	●	●						
	1-10 µl	●	●						
	2-20 µl			●		T ● F -			
	10-100 µl			■	●	T ● F -			
	20-200 µl			■	■	●	●		
	100-1000 µl							●	●
	500-5000 µl								
	1000-10000 µl								
		Multi-channel pipettes							
Sapphire	8/12 CH 0.5-10 µl	●	●						
	8/12 CH 2-20 µl			●		T ● F -			
	8/12 CH 20-200 µl			■	■	●	●		
	8/12 CH 20-300 µl			■	■	■	●		

BRAND

		Single-channel pipettes							
Transferpette® S	0.5-10 µl	●	●						
	2-20 µl	■	■	●		T ● F -			
	10-100 µl			■		T ● F -			
	20-200 µl			■	■	●	●		
	100-1000 µl							●	T ● F -

EPPENDORF

		Single-channel pipettes							
Reference®	0.5-10 µl	●	●						
	2-20 µl			●	●	T ● F -			
	10-100 µl			■	●	T ● F -			
	50-200 µl				■	●	●		
	100-1000 µl							●	●
Research®	0.5-10 µl	●	●						
	2-20 µl			●	●	T ● F -			
	10-100 µl			■	●	T ● F -			
	20-200 µl			■	■	●	●		
	100-1000 µl							●	●
Research® plus	0.5-10 µl	●	●						
	10-100 µl			■	●	T ● F -			
	20-200 µl				■	●	●		
	100-1000 µl							●	●

PIPETTE TIPS (STANDARD / LOW RETENTION)

Volume [μ l]	10	10 extended	20	100	200	300	1000	1250
Volume range [μ l]	0.2-10	0.5-10	2-20	2-100	5-200	10-300	50-1000	50-1250
Tip version	Tip/ Filter tip	Tip/ Filter tip	Filter tip	Filter tip	Tip/ Filter tip	Tip/ Filter tip	Tip	Tip/ Filter tip
Article no.	7713XX	7723XX	7733XX	7743XX	7753XX	7763XX	7773XX	7783XX

PIPETTE MODELS

Research [®] pro	0.5-10 μ l	●	●					
	5-100 μ l				●	T ● F -		
	20-300 μ l						●	
Fixed-volume pipettes								
Reference [®]	50 μ l				●	T ● F -		
	100 μ l				●	T ● F -		
	500 μ l						●	●
	1000 μ l						●	●
Research [®]	500 μ l						●	●
Multi-channel pipettes								
Eppendorf	8CH 10-200 μ l			■	■	●	●	
Research [®]	12CH 0.5-10 μ l	●	●					
Research [®] plus	8CH 0.5-10 μ l	●	●					
	8CH 10-100 μ l			■	●	●	●	
	8CH 20-300 μ l			■	■	■	●	
Electronic pipettes								
Xplorer [®]	50-1000 μ l						●	●
	8CH 15-300 μ l			■	■	■	●	

GILSON

Single-channel pipettes								
Pipetman [®]	P2 (0.5-2 μ l)	●	●					
	P10 (1-10 μ l)	●	●					
	P20 (2-20 μ l)			●		T ● F -		
	P100 (20-100 μ l)			■	●	●		
	P200 (50-200 μ l)			■	■	●	●	
	P1000 (200-1000 μ l)						●	●
Pipetman [®] L	P2L (0.2-2 μ l)	●	●					
	P10L (1-10 μ l)	●	●					
	P20L (2-20 μ l)			●		T ● F -		
	P200L (20-200 μ l)				■	●	●	
	P1000L (100-1000 μ l)						●	●
Fixed-volume pipettes								
Pipetman [®]	F5 (5 μ l)			●		T ● F -		
	F10 (10 μ l)			●		T ● F -		
	F20 (20 μ l)			●		T ● F -		
	F25 (25 μ l)				●	T ● F -		

T = Pipette tip
F = Filter tip

● compatible - not compatible
■ Pipetting volume limited to the maximum volume of the pipette tips

PIPETTE TIPS (STANDARD / LOW RETENTION)

Volume [μ l]	10	10 extended	20	100	200	300	1000	1250
Volume range [μ l]	0.2-10	0.5-10	2-20	2-100	5-200	10-300	50-1000	50-1250
Tip version	Tip/ Filter tip	Tip/ Filter tip	Filter tip	Filter tip	Tip/ Filter tip	Tip/ Filter tip	Tip	Tip/ Filter tip
Article no.	7713XX	7723XX	7733XX	7743XX	7753XX	7763XX	7773XX	7783XX

PIPETTE MODELS

GILSON (continued)

Fixed-volume pipettes

Pipetman®	F100 (100 μ l)						T ● F -	
	F200 (200 μ l)				●	●		
	F250 (250 μ l)						●	
	F300 (300 μ l)						●	●
	F500 (500 μ l)						●	
	F1000 (1000 μ l)						●	●

Multi-channel pipettes

Pipetman® L	P8X 10L (0.5-10 μ l)	●	●					
	P8X 200L (20-200 μ l)			■	■	●	●	
	P8X 300L (20-300 μ l)			■	■	■	●	

IKA

Single-channel pipettes

IKA Pette vario	100-1000 μ l						●	
-----------------	------------------	--	--	--	--	--	---	--

METTLER TOLEDO

Single-channel pipettes

Rainin Pipette-Lite™	SL200 (20-200 μ l)			■	■	●	●	
Rainin Pipette-Lite™	SL1000 (100-1000 μ l)						●	●

NICHIRYO

Single-channel pipettes

Nichipet	0.5-10 μ l	●	●					
	2-20 μ l						T ● F -	
	10-100 μ l			■	●	●	●	
	20-200 μ l			■	■	●	●	
	100-1000 μ l						●	●

Multi-channel pipettes

Nichipet	8K 30-300 μ l				■	■	●	
----------	-------------------	--	--	--	---	---	---	--

SARTORIUS

Single-channel pipettes

Biohit Proline®	0.5-10 μ l	●	●					
Biohit Proline® plus	0.5-10 μ l	●	●					
	2-20 μ l			●			T ● F -	
	10-100 μ l			■	●	●	●	
	20-200 μ l			■	■	●	●	
	100-1000 μ l						●	●

Multi-channel pipettes

Biohit Proline®	8CH 0.5-10 μ l	●	●					
	8CH 25-250 μ l					■	●	
	8CH 50-300 μ l				■	■	●	

SOCOREX

Single-channel pipettes

Acura® 825	0.5-10 μ l	●	●					
------------	----------------	---	---	--	--	--	--	--

PIPETTE TIPS (STANDARD / LOW RETENTION)

Volume [μ l]	10	10 extended	20	100	200	300	1000	1250
Volume range [μ l]	0.2-10	0.5-10	2-20	2-100	5-200	10-300	50-1000	50-1250
Tip version	Tip/ Filter tip	Tip/ Filter tip	Filter tip	Filter tip	Tip/ Filter tip	Tip/ Filter tip	Tip	Tip/ Filter tip
Article no.	7713XX	7723XX	7733XX	7743XX	7753XX	7763XX	7773XX	7783XX

PIPETTE MODELS

	2-20 μ l			●		T ● F -		
	5-50 μ l				●	T ● F -		
	10-100 μ l			■	●	T ● F -		
	20-200 μ l			■	■	●	●	
	100-1000 μ l						●	●
Calibra® 822	1-10 μ l	●						
	2-20 μ l			●		T ● F -		
	10-100 μ l			■		T ● F -		
	20-200 μ l			■	■	●	●	
	100-1000 μ l						●	●
Multi-channel pipettes								
Acura® 855	8CH 5-50 μ l			■	●	T ● F -		
Calibra® 852	8CH 1-10 μ l	●	●					
	8CH 20-200 μ l			■	■	T ● F -		
	12CH 10-100 μ l			■		T ● F -		

STARLAB

Single-channel pipettes								
ErgoOne®	0.1-2.5 μ l		●					
	0.5-10 μ l	●	●					
	10-100 μ l			■	●	T ● F -		
	100-1000 μ l						●	●
Multi-channel pipettes								
ErgoOne®	8 CH 30-300 μ l				■	■	●	

THERMO FISHER SCIENTIFIC

Single-channel pipettes								
Finnpipette™ F1	1-10 μ l	●	●					
	2-20 μ l			●		T ● F -	●	
	20-200 μ l			■	■	●	●	
	30-300 μ l						●	
	100-1000 μ l						●	●
Finnpipette™ 4500	200-1000 μ l						●	●
Multi-channel pipettes								
Finnpipette™ F1 MCP8	8 CH 1-10 μ l	●	●					
	8 CH 10-100 μ l			■	●	●	●	
	8CH 30-300 μ l				■	■	●	
Finnpipette™ 4510	8CH 50-300 μ l				■	■	●	
Finnpipette™ 4500	8CH 200-1000 μ l						●	●

VWR

Single-channel pipettes								
Erg. High Perform.	0.5-10 μ l	●	●					
Erg. High Perform.	2-20 μ l			●		T ● F -		
Erg. High Perform.	10-100 μ l			■	●	●		
Erg. High Perform.	20-200 μ l			■	■	●	●	
Erg. High Perform.	100-1000 μ l						●	●

LABORATORY INFORMATION FOR PCR

OVERVIEW PCR MICROPLATES

The use of the 96 well format allows the scale up of basic PCR work, while the 384 well format is ideal for high-throughput screening projects. All microplates are made of thin-walled polypropylene. This optimises the heat transfer from the thermoblock to

the reaction solution. Our heat-resistant sealers AMPLIseal, VIEWseal and SILVERseal are ideal for sealing the microplates during PCR, and the 96 well microplate may also be sealed with 8-cap strips.

96 WELL POLYPROPYLENE MICROPLATES FOR PCR

1/ NON-SKIRTED MICROPLATES

Non-skirted microplates may be used in all commonly available thermocyclers with a 96 well block.

1a) Non-skirted microplate with raised well rims (Art. No. 652201)

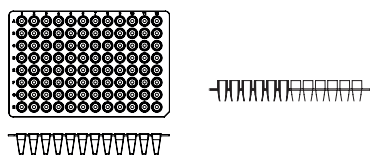

Figure 1a: View of a non-skirted microplate with raised well rims

1b) Non-skirted microplate with flat surface (Art. No. 652250)

Black alphanumeric coding enables a quick identification of samples

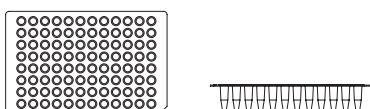

Figure 1b: View of a non-skirted microplate with flat surface

1c) Non-skirted microplate, low profile (Art. No. 652210)

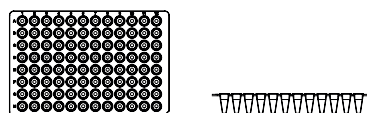

Figure 1c: View of a non-skirted low profile microplate

2/ HALF-SKIRTED MICROPLATES

2a) Half-skirted microplate with one notch suitable for real-time PCR systems such as LightCycler® 480 (Art. No. 669285)

- / Maximal pigmented white polypropylene and therefore most suitable for sensitive real-time PCR reactions
- / Black alphanumeric coding enables a quick identification of samples
- / Notches in the rim facilitate automation due to better gripping in robotic systems

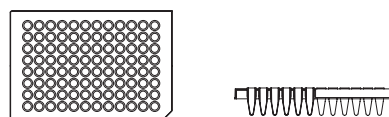

Figure 2a: View of a half-skirted microplate with one notch suitable for real-time PCR systems such as LightCycler® 480 from Roche

The registered trademarks of the mentioned manufacturers belong to the above mentioned companies.

2b) Half-skirted microplate with one notch suitable for ABI (Art. No. 652290)

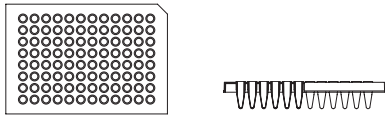

Figure 2b: View of a half-skirted microplate with one notch suitable for ABI

2c) Half-skirted microplate, recessed rim, ABI design with one notch (Art. No. 652260)

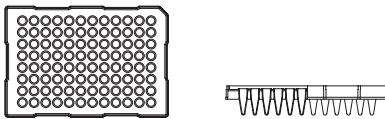

Figure 2c: View of a half-skirted microplate, recessed rim, ABI design with one notch

3/ FULL-SKIRTED MICROPLATE WITH ONE NOTCH (ART. NO. 652270)

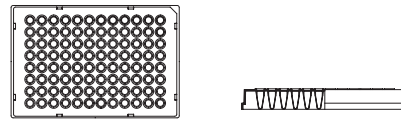

Figure 3: View of full-skirted microplate with one notch

384 WELL POLYPROPYLENE MICROPLATES FOR PCR

The 384 well PCR microplates from Greiner Bio-One are manufactured in an advanced injection moulding process following stringent quality criteria. Minimal distortion and sagging curvature, homogeneous heat transfer and sealing of the individual wells are essential quality criteria here. The footprint of all 384 well PCR microplates is compatible with automated systems.

1/ FULL-SKIRTED 384 WELL MICROPLATE WITH ONE NOTCH SUITABLE FOR ABI (ART. NO. 785290)

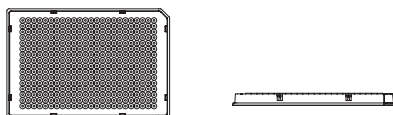

Figure 4: Full-skirted 384 well microplate with one notch and alphanumeric coding suitable for ABI

2/ FULL-SKIRTED 384 WELL MICROPLATE WITH TWO NOTCHES (ART. NO. 785201)

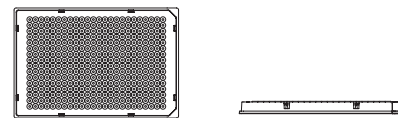

Figure 5: Full-skirted 384 well microplate with two notches and alphanumeric coding

3/ FULL-SKIRTED 384 WELL MICROPLATE WITH TWO NOTCHES FOR REAL-TIME PCR SYSTEMS (ART. NO. 785285)

- / White pigmentation boosts real-time PCR signal
- / Black alphanumeric coding enables a quick identification of samples

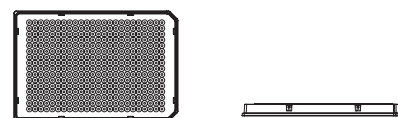

Figure 6: Full-skirted 384 well microplate with two notches for real-time PCR systems such as LightCycler® 480 from Roche

The registered trademarks of the mentioned manufacturers belong to the above mentioned companies.

COMPATIBILITY FOR PCR MICROPLATES

▲ Optimal Fit	Model	65201 unskirted, chimney top	65250 unskirted, universal	65210 unskirted, low-profile	65260 semi-skirted, ABI-Design	65270 skirted	65290 semi-skirted, suitable for ABI	669265 semi-skirted, RT-PCR	785201 skirted	785285 skirted, RT-PCR	785290 skirted, suitable for ABI		
Applied Biosystems	96 well											384 well	
	Thermal Cyclers	2700	•	•		•		•				•	
		2720				▲						•	
		6100				▲							
		9600	•	•		•		•					
		9700	•	•		▲		•				▲	
		Veriti 0.2 ml				▲		▲				•	
	Real Time Thermal Cyclers	5700		•		•		•					
		PRISM 7000		•		▲		▲					
		7300		•		▲		▲					
		7500		•		▲		▲					
		7700		•		•		▲					
		7900HT		•		▲						•	
		ViiA 7				▲						•	
		Quant Studio 12K Flex				•						•	
	Sequencers	PRISM 310	•	•		•		▲					
		PRISM 3100	•	•		▲		•				▲	
		3130 (XL)	•	•		▲		▲				▲	
		3700	•	•		▲		▲				▲	
		PRISM 3730 (XL)	•	•		▲		▲				▲	
3500 (XL)					•						•		
Bio-Rad / MJ Research	Thermal Cyclers	Gene Cycler	•	•		•							
		PTC-100	•	•	•		▲	•			•		
		PTC-200	•	•	•		▲	•			•		
		PTC-225 Tetrad	•	•	•		▲	•			•		
		Dyad/Dyad Disciple	•	•	•		▲	•			•		
		iCycler	•	•			•	▲					
		MyCycler	•	•									
		Mini Gradient		•	•								
		Personal		•				•					
		T100		▲			▲						
	Real Time Thermal Cyclers	DNA Engine family		•	•		•	•		•		•	
		C1000/S1000		•	▲		•	•		•		•	
		Opticon/Opticon2		•	•		▲						
		Chromo-4			•		•						
		iCycler	•	•			•	▲					
		MyiQ	•	•			•	▲					
		iQ5	•	•			•	▲					
		CFX Connect			•		•	•					
Sequencers	CFX96					▲							
	CFX384								•		•		
Eppendorf	Thermal Cyclers	BaseStation					•						
		Mastercycler	•	•	•		•	•					
		Mastercycler ep Gradient	•	•		•	▲	•					
		Mastercycler M384								•		•	
		Mastercycler Nexus		•	•		•	•					
		Mastercycler Nexus Gradient		•	•		▲	•					
		Mastercycler Nexus Eco		•	•		•	•					
	Mastercycler Pro		•			•	•		•		•		
Real Time T.C.	Mastercycler ep Realplex	•	•			▲	•						

The registered trademarks of the mentioned manufacturers belong to the above mentioned companies. This compatibility chart is a general guide only and subject to error and modifications. We cannot accept any liability or responsibility for the above information.

▲ Optimal Fit		Model	652201 unskirted, chimneytop	652260 unskirted, universal	652210 unskirted, low-profile	652260 semi-skirted, ABI-Design	652270 skirted	652290 semi-skirted, suitable for ABI	669285 semi-skirted, RT-PCR	786201 skirted	786285 skirted, RT-PCR	786290 skirted, suitable for ABI
			96 well						384 well			
Amers- ham	Sequencers	MegaBACE 500										
		MegaBACE 1000										
		MegaBACE 4000										
Beck- mann	Sequencers	CEQ	•									
Biometra	Thermal Cyclers	Uno	•	•	•		•	•				
		Uno II	•	•	•			•				•
		T1 Thermal Cycler	•	•	•		•	•				•
		Tgradient	•	•	•		•	•				•
		Trobot	•	•	•		•	•				•
		T3000		•	•		•					•
	T Professional		•	•		•					•	
Real Time T.C.	Toptical		•	•		•					•	
Cor- bett	Thermal Cyclers	PalmCycler 96					•	•				
		PalmCycler 384										•
Ericom	Thermal Cyclers	Power Block I	•	•	•	•						
		Deltacycler I	•	•	•			•				
		Deltacycler II	•	•	•	•						
		Single Block	•	•	•				•			
		Twin Block	•	•	•					•		
Esco	Thermal Cyclers	Swift	•	•				•				•
		Gene	•	•			•	•				•
		Genius	•	•			•	•				
G-Storm	Thermal Cyclers	GS1	•	•	•	•		•				
		GS2	•	•	•	•		•				
		GS4	•	•	•	•		•				
		GSX	•	•	•	•		•				
		GSXs	•	•	•	•		•				
MWG	Thermal Cyclers	Primus 96	•	•	•	•	•	•				
		Primus 384										
Strate- gene	Thermal Cyclers	Robocycler 96		•				•				
		Robocycler Gradient	•	•	•	•	•	•				
Real Time T.C.	Mx4000 and Mx3005P	•	•	•	•	•						
Taka- Ra	Thermal Cyclers	TP240					•					
		TP3000	•	•	•	•	•	•				
Techne	Thermal Cyclers	Touchgene	•	•	•	•		•				
		Cyclogene	•	•	•	•		•				
		Genius	•	•	•	•		•				
		Genius Quad	•	•	•	•		•				
		Genius (TC412)	•	•	•	•	•	•				
		Flexigene	•	•	•	•	•	•				•
	Touchgene X		•	•	•	•	•	•			•	
Real Time T.C.	Touchgene Gradient (TC512)	•	•	•	•	•	•				•	
Thermo Hybaid	Thermal Cyclers	PCR Sprint	•	•	•	•	•	•				
		MBS Satellite (Multiblock)	•	•	•	•	•	•				•
		Px2 and PxE	•	•	•	•	•	•				•
		PCR Express and Omni-E	•	•	•	•	•	•				•
		Touchdown	•	•	•	•	•	•				•
		Omnigene	•	•	•	•	•	•				•
Trans- gen- omic	Sequencers	WAVE System					•					
Ro- che	Real Time T.C.	LightCycler 96							•	•		
		LightCycler 480							•	•	•	•

The registered trademarks of the mentioned manufacturers belong to the above mentioned companies. This compatibility chart is a general guide only and subject to error and modifications. We cannot accept any liability or responsibility for the above information.

COMPATIBILITY FOR MINI BLOCK HEATER INSERTS

Art. no.	848916	848923	848902	848913	848921	848915	848950
No. of Tubes per Insert	15x	15x	40x	15x	15x	4x	2x
1ml Cryo.s					•		
2ml Cryo.s					•		
4ml Cryo.s				•			
5ml Cryo.s				•			
1.5ml Reaction Tube	•	•					
2ml Reaction Tube		•					
0.5ml PCR Tube	•	•					
0.2ml PCR Tube			•				
1x8 PCR Tube Strip			•				
15ml Conical Tube						•	
50ml Conical Tube							•
4ml, 12x55mm Tube					•		
5ml, 12x75mm Tube				•			
4.5ml, 12x75mm Tube				•			
7ml, 13x100mm Tube				•			
12ml, 16x100mm Tube						•	
12ml, 17x100mm Tube						•	
20ml, 16x152mm Tube						•	
14ml, 17x95mm Tube						•	
14ml, 18x95mm Tube						•	

This compatibility chart is a general guide only and subject to error and modifications. We cannot accept any liability or responsibility for the above information.

LABORATORY INFORMATION FOR CENTRIFUGATION

CENTRIFUGATION - PRINCIPLE AND CALCULATION OF THE RCF (RELATIVE CENTRIFUGAL FORCE)

Sedimentation of particles in a gravitational field

If a mixture of sand and water is shaken thoroughly and then left to stand, the sedimentation of the solid particles takes place according to their size. As a result of gravitational acceleration ($g = 9.81\text{m/s}^2$), all of the particles are located in a gravitational field under the influence of which the coarse

grains of sand collect at the bottom first and the smaller grains of sand are deposited later. After around 10–20 minutes, the following layering is produced (from bottom to top): coarse grains of sand – fine grains of sand – water. However, other particles (proteins, nucleic acids, viruses, pro- or eucaryotic cells) do not necessarily precipitate or only sediment out after they have been

exposed to higher forces than the force of gravity resulting from the gravitational acceleration. If these forces exceed the counter-forces resulting from convection (heat circulation) and Brownian molecular motion, both of which cause constant mixing of solutions and suspensions, sedimentation takes place.

The sedimentation rate can be calculated on the basis of Stoke's law as follows:

$$V = \frac{d^2(p_p - p_L)g}{18\mu}$$

However, a particle will only sediment out if $p_p > p_L$. If $p_p < p_L$, V becomes negative, consequently the particle floats rather than sedimenting out.

- / V = sedimentation rate
- p_p = density of the particle
- p_L = density of the liquid
- $g = 9.81\text{m/s}^2$
- μ = viscosity of the liquid

Influence of the Centrifugation and Calculation of the RCF respectively RPM

A centrifuge can be used to create a transient gravitational field under the influence of which the sedimentation of cells, cellular components and macro-molecules takes place. In a centrifuge, a suspension located in a centrifuge tube

rotates around a rotational axis. Each particle of the suspension is subject to centrifugal force, which moves it radially away from the rotational axis.

The centrifugal force F_c is calculated as follows:

$$F_c = m_p w^2 r$$

- / where m_p = mass of the particle,
- w = angular velocity (s^{-1}) and
- r = distance of the particle from the rotational axis

The force acting on a particle in a centrifugal field is stated relative to gravitational acceleration, usually as so-called relative centrifugal force (**RCF**) or g-force (**x g**). It is calculated as follows:

$$RCF = 11.18r \left(\frac{R}{1000} \right)^2$$

- / where R = rotor revolutions per min and r = distance of the particle from the rotational axis (cm)

For easier conversion of the **RCF** or g-force into revolutions per min, the equation can be transformed as follows:

$$R = 299 \sqrt{\frac{RCF}{r}}$$

ALIGNMENT CHART

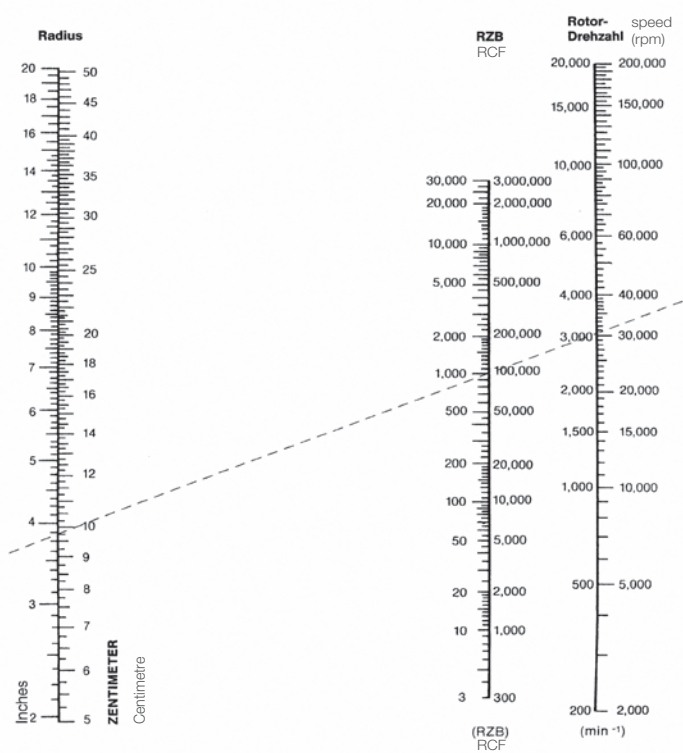

/ By use of a ruler, the third value relating to two known scale values can be read from the alignment chart.

MAXIMAL CENTRIFUGE CAPACITY OF TUBES, REACTION TUBES AND MICROPLATES

The maximum centrifuge capacity for Greiner Bio-One tubes, reaction tubes and microplates is listed in the form of the RCF in the tables below.

For centrifugation, all products were filled with water up to their maximum filling volume. Determination of the maximum RCF in a swinging-bucket rotor was conducted in a Thermo Scientific Centrifuge (Heraeus Multifuge BSR

Plus). Determination of the maximum RCF in a fixed angle rotor was conducted in a Sorvall Centrifuge (Evolution RC). Therefore special rotor inserts for different vessel shapes and sizes were used for a stable fit.

REACTION TUBES

Art. no.	Volume [ml]	max. RCF [g] fixed-angle rotor
6162XX	1.5	18000
6232XX	2.0	16000
6672XX	0.5	15000
6932XX	0.5	18000
7162XX	1.5	20000
7172XX	1.5	20000
7222XX	2.0	22000

The stated maximum RCF values are guidelines only, depending on a variety of factors such as rotor, temperature, density, pH and type of liquid. The suitability of tubes for a specific application using high centrifugation forces has to be tested.

POLYSTYRENE TUBES

Art. no.	Dimensions \varnothing [mm] x height [mm]	max. RCF [g] swinging-bucket rotor	max. RCF [g] fixed-angle rotor
1031XX	10.5 x 40	5800	- ¹
1121XX	12 x 55	5800	6200
1151XX	12 x 75	5800	5800
1161XX	12 x 75	5800	- ¹
1201XX	12.4 x 75	4800	5000
1251XX	13 x 100	4000	7500
1361XX	14 x 100	4000	5200
1601XX	16 x 100	3500	5000
1631XX	17 x 100	3000	3000
1641XX	16.8 x 100	5000	5000
1661XX	16 x 110	2500	3200
1861XX	17 x 120	2500	2800
1871XX	17 x 100	5200	6600
1881XX	17 x 120	2500	4500
1911XX	18 x 95	4000	5500
2011XX	24 x 90	1000	3500

¹ No fitting rotor inserts available.

POLYPROPYLENE TUBES

Art. no.	Dimensions \varnothing [mm] x height [mm]	max. RCF [g] swinging-bucket rotor	max. RCF [g] fixed-angle rotor
1022XX	8.5 x 44	5800	20000
1122XX	12 x 55	5800	30000
1152XX	12 x 75	5800	34000
1212XX	12.5 x 48	5800	34000
1222XX	12.5 x 48	5800	34000
1232XX	12.5 x 42	5800	26000
1242XX	12.5 x 86	5800	34000
1262XX	12.4 x 47	5800	26000
1272XX	12.4 x 83	5800	34000
1602XX	16 x 100	5800	33000
160297	16 x 100	3500	33000
1632XX	16 x 100	5000	26000
184261	17 x 77	4800	34000
187201	17 x 100	4800	34000
187261	18 x 95	4800	34000
1882XX	17 x 120	4000	15000
1912XX	18 x 95	4800	34000
2102XX	30 x 115	2800	9500
2272XX	30 x 115	3200	9500
227261	30 x 115	3200	17000
227270	30 x 115	3200	17000
227281/ 227285	30 x 115	3200	9500
227280/ 227283	30 x 115	3200	9000

The stated maximum RCF values are guidelines only, depending on a variety of factors such as rotor, temperature, density, pH and type of liquid. The suitability of tubes for a specific application using high centrifugation forces has to be tested.

POLYETHYLENE TUBES

Art. no.	Dimensions \varnothing [mm]xheight [mm]	max. RCF [g] swinging-bucket rotor	max. RCF [g] fixed-angle rotor
1123XX	12x55	4200	22000
1153XX	12x75	4200	20000
1603XX	16x100	3500	30000
1873XX	17x100	5800	20000

MULTIWELL PLATES

Art. no.	Multiwell Plate	max. RCF [g] swinging-bucket rotor
657160	6 well, PS, clear	4800
665102	12 well, PS, clear	4800
662160	24 well, PS, clear	4800
677180	48 well, PS, clear	4800

MICROPLATES

Art. no.	Microplate	max. RCF [g] swinging-bucket rotor
650101	96 well, PS, U-bottom, clear	1000
651101	96 well, PS, V-bottom, clear	1000
655101	96 well, PS, F-bottom, clear	4800
650201	96 well, PP, U-bottom, natural	4800
651201	96 well, PP, V-bottom, natural	4800
655201	96 well, PP, F-bottom, natural	4800
655209	96 well, PP, U-bottom, black	4800
655074	96 well, PS, F-bottom, white	4800
655076	96 well, PS, F-bottom, black	4800
655094	96 well, PS, μ Clear [®] , white	4800
655096	96 well, PS, μ Clear [®] , black	4800
655801	96 well, PS, UV-Star [®]	4800
780201	96 well, PP, MASTERBLOCK [®] 1 ml	4800
780270	96 well, PP, MASTERBLOCK [®] 2 ml	4800
786201	96 well, PP, MASTERBLOCK [®] 0.5 ml	4800
781101	384 well, PS, clear	4800
781073	384 well, PS, white	4800
781077	384 well, PS, black	4800
781094	384 well, PS, μ Clear [®] , white	4000
781096	384 well, PS, μ Clear [®] , black	3000
781201	384 well, PP, F-bottom, natural	4800
781280	384 well, PP, V-bottom, natural	4800
781270	384 well, PP, V-bottom, Deep Well, natural	4800
781801	384 well, PS, UV-Star [®]	4800

The stated maximum RCF values in these tables are guidelines only, depending on a variety of factors such as rotor, temperature, density, pH and type of liquid. The suitability of tubes and plates for a specific application using high centrifugation forces has to be tested.

MICROPLATES

Art. no.	Microplate	max. RCF [g] swinging-bucket rotor
784101	384 well, PS, Small Volume, clear	800
784075	384 well, PS, Small Volume, white	800
784076	384 well, PS, Small Volume, black	800
784201	384 well, PP, Small Volume, natural	4800
782101	1536 well, PS, HiBase, clear	1800
782074	1536 well, PS, HiBase, white	1500
782077	1536 well, PS, HiBase, black	1500
782094	1536 well, PS, μ Clear [®] , HiBase, white	1000
782096	1536 well, PS, μ Clear [®] , HiBase, black	1500
782270	1536 well, PP, V-bottom, Deep Well, natural	4800
783101	1536 well, PS, LoBase, clear	4800
783075	1536 well, PS, LoBase, white	4800
783076	1536 well, PS, LoBase, black	4800
783094	1536 well, PS, μ Clear [®] , LoBase, white	4800
783096	1536 well, PS, μ Clear [®] , LoBase, black	4800

PCR PLATES

Art. no.	PCR Plate	max. RCF [g] swinging-bucket rotor
652270	96 well, PP, natural, full-skirt	4800
652290	96 well, PP, natural, half-skirt, suitable for ABI	4800
785201	384 well, PP, natural, full-skirt	4800
785290	384 well, PP, natural, full-skirt, suitable for ABI	4800

For centrifugation the plates were filled with water as follows: 96 well = 300 μ l | 384 well = 50 μ l | 1536 well = 5 μ l

The stated maximum RCF values in these tables are guidelines only, depending on a variety of factors such as rotor, temperature, density, pH and type of liquid. The suitability of tubes and plates for a specific application using high centrifugation forces has to be tested.

LABORATORY INFORMATION FOR CRYO.S SAMPLE STORAGE

FREEZING PROTOCOL

1

Wash the cells with warm PBS solution, aspirate the solution and cover the cells with a solution containing trypsin and EDTA (a thin liquid film is enough; the concentration should be evaluated for each cell line).

2

Incubate the cells for max. 3–5 min at 37°C.

3

Once the cells detach from the bottom, stop incubation by adding cell culture medium supplemented with serum and slightly suspend cells using a pipette.

4

Spin down the suspension (500xg, 5 min) and re-suspend the pellet with medium containing serum.

5

Determine the cell number (using a Neubauer chamber).

6

Spin down the cells for 5 min at 500xg and discard the supernatant. Resuspend the pellet with an adequate volume of cell culture medium containing serum.

7

Mix the cell suspension 1:1 with freezing medium (60 % medium, 20 % FCS, 20 % DMSO) and transfer it in Cryo.s. For freezing in Cryo.s, the concentration of cells should be 1–5x10⁶ cells/ml.

8

Cryo.s containing cells should be frozen at a cooling rate of -1K/min. This can be achieved by placing them into an isopropanol-filled chamber at -70°C. If other types of samples are contained, Cryo.s may be frozen directly at -20°C, -70°C or in the gas phase of liquid nitrogen. In order to assure even freezing of the sample, 4 and 5 ml Cryo.s should be frozen at -20°C overnight before transferring them to -70°C or to the gas phase of liquid nitrogen.

9

Then transfer the Cryo.s into the nitrogen tank. To avoid contamination (e.g. mycoplasma) and due to safety precautions Cryo.s must only be stored in the **gas phase** above and not in the liquid nitrogen.

THAWING PROTOCOL

1

Immediately after removing them out of the nitrogen tank the frozen cells are thawed in about 1-2 min brandishing the Cryo.s in a water bath at 37°C. The thawing process should be performed as fast as possible.

2

Transfer the thawed cell suspension into a 15ml tube and mix it immediately with copious amounts of cell culture medium containing serum.

3

After spinning down the cells (500xg, 5min) discard the supernatant and resuspend the pellet in an appropriate cell culture medium supplemented with serum and transfer it into one or more cell culture flasks.

4

Follow the recommended cell concentration for seeding.

5

During the next 12 hours cells should rest.

6

A change of medium is recommended after 24 resp. 48 hours.

SAFETY ADVISORY FOR WORKING WITH CRYO.S

Cryo.s, tubes are intended for sample storage exclusively in the gas phase over liquid nitrogen or in freezers! If Cryo.s are stored in the liquid phase, nitrogen can seep into the tubes. Then upon thawing the vaporising nitrogen can generate high pressure, ultimately resulting in an explosion, as well as the release of any infectious material.

Always take appropriate personal safety measures when working with Cryo.s, including wearing safety clothing, using goggles

and working at a safety laboratory bench. When undertaking cryogenic preservation, Cryo.s must be evenly exposed to freezing temperatures. Uneven temperature exposures can cause formation of ice plugs (i. e. at tube top) that inhibit the expansion of freezing liquid (i. e. at tube bottom), resulting in dangerous high pressure and subsequent harm or damage of tubes.

Never exceed maximum working volumes as specified.

LABORATORY INFORMATION FOR IMMUNOLOGY

VOLUME-DEPENDENT WETTING OF IMMUNOLOGICAL PRODUCTS

Liquid volume [μl]	Covered area [mm ²]	Liquid height [mm]	Area / volume ratio [cm ² / cm ³]
96 Well ELISA Microplate, U-Bottom			
25	34	1.7	13.6
50	52	2.6	10.4
75	68	3.4	9.1
100	84.6	4.2	8.5
125	99	4.9	7.9
150	115.5	5.7	7.7
175	130	6.4	7.4
200	145	7.1	7.3
225	160	7.8	7.1
250	174.7	8.5	7.0
275	190	9.2	6.9
300	205	9.9	6.8
96 Well ELISA Microplate, V-Bottom			
25	35	2.3	14.0
50	54.6	3.4	10.9
75	72.4	4.4	9.7
100	88.6	5.3	8.9
125	105	6.2	8.4
150	123.8	7.2	8.3
175	140.8	8.1	8.0
200	156	8.9	7.8
96 Well ELISA Microplate, F-Bottom / Standard			
25	47	0.8	18.8
50	62	1.55	12.4
75	77.5	2.3	10.3
100	92	3.0	9.2
125	108	3.8	8.6
150	123	4.5	8.2
175	137.6	5.2	7.9
200	152.3	5.9	7.6
225	168	6.65	7.5
250	183	7.35	7.3
275	197	8.0	7.2
300	212	8.7	7.1
96 Well ELISA Microplate, F-Bottom / Chimney Well			
25	47	0.7	18.8
50	64	1.5	12.8
75	78.5	2.2	10.5
100	93	2.9	9.3
125	108	3.6	8.6
150	122.6	4.3	8.2
175	137.5	5.0	7.9
200	152	5.7	7.6
225	167	6.4	7.4
250	182	7.1	7.3
275	197	7.8	7.2
300	212	8.4	7.1

Liquid volume [μl]	Covered area [mm ²]	Liquid height [mm]	Area / volume ratio [cm ² / cm ³]
96 Well ELISA Microplate, F-Bottom, Half Area			
25	38	1.65	15.2
50	60	3.2	12.0
75	81.5	4.7	10.9
100	103.6	6.2	10.4
125	124.5	7.6	10.0
150	144	8.9	9.6
175	165.8	10.3	9.5
200	181.7	11.5	9.1
C8 Strip Plate			
25	39	1.0	15.6
50	56	1.9	11.2
75	73	2.8	9.7
100	88.6	3.6	8.9
125	104.3	4.4	8.3
150	120	5.2	8.0
175	136.5	6.0	7.8
200	150.8	6.7	7.5
225	165.4	7.4	7.4
250	181	8.15	7.2
275	196	8.85	7.1
300	211	9.55	7.0
F8 Strip Plate			
25	50.4	0.8	20.2
50	64	1.45	12.8
75	79.7	2.2	10.6
100	93.5	2.85	9.4
125	108.3	3.55	8.7
150	123	4.25	8.2
175	138	4.95	7.9
200	153	5.65	7.7
225	167	6.3	7.4
250	182	7.0	7.3
275	196	7.65	7.1
300	211.5	8.35	7.1
U8 Strip Plate			
25	34	1.7	13.6
50	52	2.6	10.4
75	68	3.4	9.1
100	84	4.2	8.4
125	99.6	4.95	8.0
150	115	5.75	7.7
175	129.6	6.45	7.4
200	144	7.15	7.2
225	159	7.85	7.1
250	174	8.55	7.0
275	189	9.25	6.9
300	204	9.95	6.8

Liquid volume [μl]	Covered area [mm ²]	Liquid height [mm]	Area / volume ratio [cm ² / cm ³]
U16 Strip Plate			
25	35	1.75	14.0
50	52	2.6	10.4
75	68	3.4	9.1
100	84	4.2	8.4
125	98.6	4.9	7.9
150	115	5.7	7.7
175	129.6	6.4	7.4
200	144	7.1	7.2
225	159	7.8	7.1
250	174	8.5	7.0
275	189	9.2	6.9
300	204	9.9	6.8

Liquid volume [μl]	Covered area [mm ²]	Liquid height [mm]	Area / volume ratio [cm ² / cm ³]
F16 Strip Plate			
25	49	0.8	19.6
50	63	1.5	12.6
75	79.8	2.3	10.6
100	94.3	3.0	9.4
125	108	3.7	8.6
150	123.5	4.4	8.2
175	138	5.1	7.9
200	153	5.8	7.7
225	168	6.5	7.5
250	183	7.2	7.3
275	198	7.9	7.2
300	213	8.6	7.1
384 Well Microplate, F-Bottom			
25	39.07	2.50	15.6
50	66.60	4.8	13.3
75	94.03	7.00	12.5
100	119.63	9.05	12.0
125	145.6	11.05	11.6
132	152.6	11.50	11.6

Abbreviations

ANSI	American National Standards Institute	PLL	Poly-L-Lysine
COC	Cycloolefin co-polymer	PP	Polypropylene
COP	Cycloolefin polymer	PS	Polystyrene
CV	Coefficient of Variation	PTFE	Polytetrafluoroethylene
DMSO	Dimethyl Sulphoxide	RNA	Ribonucleic Acid
DNA	Deoxyribonucleic Acid	RNase	Ribonuclease
DNase	Deoxyribonuclease	rRNA	Ribosomal RNA
ECM	Extracellular Matrix	RT	Room Temperature
EL-Rack	EasyLoad® Rack	SBS	Society for Biomolecular Sciences
ELISA	Enzyme Linked Immuno Sorbent Assay	SPA	Scintillation Proximity Assays
EVA	Ethyl Vinyl Acetate	ST-Rack	Standard Rack
FDA	Food and Drug Administration	TC	Tissue Culture
FIA	Fluorescence Immuno Assay	USP	United States Pharmacopoeia
F-Rack	Filter Tip Rack	UV Spectrum	Ultraviolet Spectrum
HDPE	High Density Polyethylene	VIS Spectrum	Visible Spectrum
HLA	Human Leucocyte Antigen		
HTS	High-Throughput Screening	Units	
IgG	Immunoglobulin G	°C	Degree Centigrade
ID-Card	Identity Card	Da	Dalton, the unit of molecular mass
LAL	Limulus Amoebocyte Lysate	g	Gram or Gravitational
LIA	Luminescence Immuno Assay		Acceleration (about 9.81 m/s ²)
med.	Medium	Gy	Gray, Radiation Unit
NMWC0	Nominal Molecular Weight Cut-Offs	h	Hour
PC	Polycarbonate	l	Liter
PCR	Polymerase Chain Reaction	M	Molarity, moles of solute per litre of solution
PDL	Poly-D-Lysine	m	Meter
PET	Polyethylene Terephthalate	min	Minute
PETG	Polyethylene Terephthalate Copolymer	Mol	Absolute Amount of Substance
pH	pH Value	s	Second
PLA	Poly lactate		

GLOSSARY

Advanced TC is a polymer modification increasing the cellular primary and long-term adhesion of Greiner Bio-One cell culture vessels. Based on the innovative technique the surface of the cell culture vessels is modified to positively influence cellular features and functions. Enhanced cellular adhesion and higher proliferation rates improve cell expansion and cultivation of sensitive cells or cells under restricted growth conditions.

Biobanking Tubes are 300µl, 600µl and 1000µl Cryo.s tubes for the efficient storage of biological samples in large-scale biorepositories. The design of tubes and racks allows for a very space-efficient storage with up to 30 % better utilisation of storage space in freezers or liquid nitrogen tanks. In addition, they are optimised for sample storage at extremely low temperatures over long periods of time.

Bioburden is used to describe the colonisation of viable microorganisms on a material or product and is the basis for determining the necessary radiation dose for sterilisation.

C-bottom stands for the well profile of a flat well bottom with rounded corners.

CELLCOAT® is the Greiner Bio-One brand name for all protein-coated cell culture vessels for adherent cell culture.

CELLMASTER is a quality term that refers to all roller bottles.

CELLreactor is a 15ml/50ml polypropylene tube with filter screw cap for the cultivation of suspension and spheroid cells, expansion of aerobic bacteria, yeast or other microorganisms as well as storage of components and liquids requiring gas exchange.

Cell-repellent surface reliably prevents cell attachment in suspension cultures of semi-adherent and adherent cell lines where standard hydrophobic surfaces generally used for suspension culture are insufficient.

CELLSTAR® is a Greiner Bio-One brand name and includes culture vessels with physically modified surfaces for adherent or suspension cell cultures.

CELLview is a quality term for cell culture products with glass bottom for high-resolution microscopic applications.

Datamatrix Code is a 2D barcode which can also be used for tracking biological and medical reagents and samples. Its small footprint provides nearly infinite scalability and large data capacity. Datamatrix codes can be scanned independent of their orientation and are very accurate due to the Reed-Solomon error correction method.

Deep Well microplates have conical bottom wells and are ideally suited for the storage of non-human samples.

EASYstrainer are cell strainers for the fast and safe filtration of cell suspensions such as those from tissue

dissociation or for flow cytometry.

F-bottom stands for a flat bottom well profile.

F-bottom/ chimney well stands for the well profile of a flat well bottom in a chimney-like arrangement. In other words, each well stands on its own. The risk of contamination from sample material being carried over is minimised.

FLUOTRAC is a quality term for immunological products, referring to black microplates (fluorescence measurement).

FourWell Plate is a subdivided plate for microscopic applications facilitating the cultivation of cells and the storage of microscopic slides in an HTS-compatible plate complying with ANSI standards.

Hanging Drop is a technique for protein crystallisation based on > vapour diffusion, where droplets literally hang from the top of an upper substrate.

HiBase is a special plate profile of 384 well > Small Volume and 1536 well microplates. In contrast to the > LoBase profile, the HiBase profile is particularly well suited for top-reading systems, since the measuring optic has a minimal separation from the upper edge of the well in this plate profile.

High binding microplates (= MICROLON 600, FLUOTRAC 600 and LUMITRAC 600) are immunological microplates with a high-binding polystyrene surface. Hydrophilic groups are introduced to the polystyrene surface by physical treatment. The high binding surface contains more hydrophilic groups than the less hydrophilic > medium binding surface.

LoBase is a special plate profile in 1536 well microplates. In contrast to the > HiBase profile, the LoBase profile is particularly well suited for bottom-reading systems, since the measuring optic has a minimal separation from the well bottom in this plate profile.

LUMITRAC is a quality term for immunological products, referring to white microplates (luminescence measurement).

MASTERBLOCK® is a brand name that stands for polypropylene microplates that are suitable for the storage of non-human sample material. They are also ideally suited for cultivating bacteria or yeast.

Med. binding (medium binding) microplates (= MICROLON 200, FLUOTRAC 200 and LUMITRAC 200) are immunological microplates with a less hydrophobic surface than > high binding microplates.

Microbatch under oil is a method for protein crystallisation where the droplet is covered with oil. The oil generally used is paraffin wax and/or silicone oil. Paraffin wax allows little to no diffusion of water out of the droplet. Hence, all the reagents involved in the crystallisation process, as well as the protein, are present at defined concentrations, and no significant increase of concentration occurs

within the crystallisation droplet. When paraffin wax is mixed with silicone oil, it is possible for water to diffuse out of the droplet through the oil and both protein and reagent concentrations increase within the droplet.

µClear® (Micro-Clear) microplates, in contrast to standard microplates with a solid bottom, have a very thin foil bottom. µClear® microplates are ideal for cell-based test systems, microscopic analyses, as well as for bottom-reading systems.

MICROLON is a quality term for immunological products, referring to clear microplates (transmission measurement).

Non-binding microplates are characterised by low protein, DNA, RNA and peptide binding properties.

OneWell Plate is a non-divided HTS plate for tissue culture applications complying with the ANSI standards. The plate is also available in a non-TC-treated version for bacteriology.

Sapphire is a quality term for pipette and filter tips. The product family comprises standard pipette tips, standard filter tips as well as a low-retention version of both. All tips are transparent, graduated and allow precise pipetting with maximal recovery. They can be used with all common pipettes.

SCREENSTAR is a quality term for microplates manufactured out of high-quality cycloolefin with an ultra-clear film bottom for high-content and high-throughput screening.

Sitting Drop is a technique for protein crystallisation based on vapour diffusion, where droplets sit on the bottom of a substrate.

Small Volume is a well profile that was developed in 384 well format for reducing the sample volume.

In contrast to the 384 well standard microplate, the sample volume can be considerably reduced, while the detection limit remains the same or is even improved.

TC surface treatment stands for a special physical procedure with which the surfaces of CELLSTAR® products for adherent cell culture are treated. This treatment leads to the incorporation of polar groups, such as carboxy and hydroxy groups, into the plastic surface making it hydrophilic. This enables the adhesion of cells to the plastic surface.

U-bottom stands for well profile of wells with round bottom.

UV-Star® microplates are made of polyolefin and have a film bottom. In contrast to standard microplates with a solid bottom, they are characterised by an extended transparency range to as low as 200 nm.

Vapour diffusion is the most commonly used method for protein crystallisation. In this method a crystallisation droplet, formed by combining a protein solution with a reagent solution, is incubated together with a larger volume of the same reagent solution within a closed system. The reagent solution can contain a wide range of chemicals, e.g. buffers, salts or precipitating agents. Due to mixing the reagent and protein solutions, the concentration of reagents within the crystallisation droplet becomes lower than the concentration of the reagent solution itself. This causes water to evaporate out of the droplet until equilibrium is reached. During this process, the concentration of protein and chemicals in the crystallisation droplet is continuously rising, and, if optimal conditions have been chosen, protein crystals will begin to form. Vapour diffusion experiments are most often set up as hanging or sitting drop.

V-bottom stands for the well profile of wells with a conically tapered well bottom.

GLOSSARY OF SYMBOLS

	Manufacturer		Keep dry		Use-by date
	In vitro diagnostic medical device		Caution		This way up
	Batch code		Do not re-use		Fragile, handle with care
	Article number		Consult instructions for use		Temperature limit
	Sterilised by irradiation		Do not use if package is damaged		

NUMERICAL INDEX

102201.....	166	127279.....	187	227280.....	169	542070.....	71	627871.....	103
102250.....	125	127280.....	187	227281.....	169	542100.....	71	627960.....	47
102261.....	166	131202.....	196	227283.....	169	542120.....	71	627965.....	49
102270.....	166	131263.....	195	227285.....	169	542140.....	71	627965.....	103
102280.....	125	132202.....	198	227288.....	174	542170.....	71	627975.....	50
102285.....	125	132263.....	197	227289.....	174	543078.....	105	627975.....	103
112101.....	165	133202.....	200	227290.....	174	543079.....	105	627979.....	49
112201.....	165	133263.....	199	303321.....	166	543978.....	105	627979.....	87
115001.....	150	136101.....	165	304134.....	188	543979.....	105	628102.....	157
115061.....	150	160101.....	165	310321.....	166	604107.....	242	628160.....	47
115070.....	150	160201.....	165	315361.....	38	604160.....	242	628160-TRI.....	47
115071.....	150	163160.....	69	330070.....	178	604160-TRI.....	243	628161.....	157
115101.....	165	163177.....	172	332070.....	178	604181.....	242	628910.....	48
115201.....	165	163288.....	174	350382.....	38	606107.....	242	628920.....	48
115261.....	172	163289.....	174	354070.....	178	606160.....	242	628930.....	48
115262.....	172	163290.....	174	358361.....	38	606160-TRI.....	243	628940.....	48
120160.....	69	164160.....	69	365250.....	125	606180.....	242	628950.....	48
120161.....	172	164161.....	171	365251.....	125	606190.....	243	628960.....	47
120180.....	172	164180.....	171	365280.....	125	607107.....	242	628979.....	49
120190.....	69	169101.....	165	365281.....	125	607160.....	242	628979.....	87
121261.....	186	186171.....	172	366350.....	170	607160-TRI.....	243	629161.....	158
121263.....	186	187101.....	165	366351.....	170	607180.....	242	629180.....	158
121277.....	186	187201.....	165	366353.....	170	607190.....	243	632102.....	157
121278.....	186	187261.....	172	366354.....	170	608281.....	218	632161.....	157
121279.....	186	187262.....	172	366355.....	171	608283.....	219	632180.....	157
121280.....	186	188161.....	172	366356.....	171	608284.....	219	632181.....	157
122261.....	186	188171.....	172	366357.....	171	608285.....	219	633180.....	157
122263.....	186	188241.....	69	366380.....	210	608286.....	219	633181.....	157
122263-2D3.....	192	188241.....	170	366383.....	210	608287.....	219	635102.....	158
122263-2DG.....	192	188261-N.....	168	366384.....	210	609101.....	141	635161.....	158
122263-TRI.....	186	188271-N.....	168	366385.....	210	609120.....	141	639102.....	157
122277.....	186	188271-TRI.....	168	366386.....	210	609130.....	141	639160.....	47
122278.....	186	188280.....	168	373250.....	220	609171.....	141	639160-TRI.....	47
122279.....	186	188281.....	168	373270.....	219	609180.....	141	639161.....	157
122280.....	186	188283.....	168	373273.....	219	609801.....	141	639960.....	48
123261.....	185	188285.....	168	373274.....	219	609820.....	141	643201.....	43
123263.....	185	189175.....	177	373275.....	219	609830.....	141	643201.....	160
123263-2D3.....	192	189176.....	177	373276.....	219	609871.....	141	643203.....	43
123263-2DG.....	192	191160.....	69	373277.....	220	612301.....	244	643203.....	160
123263-TRI.....	185	191161.....	172	373281.....	220	612302.....	245	643401.....	43
123277.....	185	191180.....	172	374270.....	221	612361.....	244	643401.....	160
123278.....	185	201150.....	176	374273.....	221	612362.....	244	644201.....	43
123279.....	185	201152.....	176	374274.....	221	612381.....	245	644201.....	160
123280.....	185	201170.....	176	374275.....	221	612382.....	245	644203.....	43
124261.....	188	201172.....	176	374276.....	221	612398.....	245	644203.....	160
124263.....	188	201180.....	44	381061.....	139	612399.....	245	644401.....	43
124273.....	188	205101.....	178	381070.....	139	613101.....	212	644401.....	160
124274.....	188	210261.....	169	381080.....	139	614101.....	212	646201.....	43
124275.....	188	210270.....	169	381081.....	139	616201.....	209	646201.....	160
124276.....	188	217101.....	178	385270.....	201	616261.....	209	646203.....	43
126261.....	186	219102.....	177	385273.....	201	616283.....	209	646203.....	160
126263.....	186	219190.....	177	385274.....	201	622201.....	210	646401.....	43
126263-2D1.....	192	224170.....	176	385275.....	201	622261.....	210	646401.....	160
126263-2DG.....	192	224180.....	177	385276.....	201	623201.....	209	649201.....	43
126263-TRI.....	186	225180.....	176	385277.....	201	627102.....	157	649201.....	160
126277.....	187	225185.....	177	385278.....	201	627160.....	47	649203.....	43
126278.....	187	227245.....	69	385279.....	201	627161.....	157	649203.....	160
126279.....	187	227245.....	170	443103.....	44	627170.....	47	649401.....	43
126280.....	187	227250.....	174	501870.....	141	627860.....	49	649401.....	160
127261.....	187	227255.....	174	503850.....	141	627860.....	103	650001.....	145
127263.....	187	227261.....	169	503870.....	141	627861.....	49	650061.....	145
127263-2D1.....	193	227261-N.....	169	541070.....	42	627861.....	103	650061.....	145
127263-2DG.....	192	227261-TRI.....	169	541080.....	42	627870.....	50	650101.....	115
127277.....	187	227270.....	169	542000.....	71	627870.....	103	650160.....	61
127278.....	187	227270-N.....	169	542040.....	71	627871.....	49	650161.....	115

650162	115	655680	59	657824	93	662631	57	674276	220
650172	115	655801	136	657825	92	662631	98	674277	220
650180	61	655809	136	657830	92	662638	57	675001	145
650185	64	655830	91	657840	92	662638	98	675061	145
650188	64	655840	91	657841	94	662640	57	675074	116
650201	117	655841	91	657843	94	662640	98	675075	116
650209	117	655846	93	657846	94	662641	57	675076	116
650261	117	655850	91	657850	93	662641	98	675077	116
650901	131	655866	109	657852	94	662825	92	675083	62
650970	88	655891	107	657896	93	662830	92	675086	62
650979	88	655892	111	657930	53	662840	92	675090	63
651001	145	655900	131	657940	53	664102	157	675096	116
651061	145	655901	131	657950	53	664160	47	675101	116
651101	115	655903	131	657960	52	664160-TRI	47	675161	116
651160	61	655904	131	657970	53	664161	157	675180	62
651161	115	655906	131	657970	88	664910	48	675801	136
651180	61	655930	63	658170	37	664920	48	675986	64
651182	116	655936	63	658170-TRI	37	664940	48	676001	138
651201	117	655940	63	658175	37	664950	48	676040	139
651209	117	655944	63	658175-TRI	37	664960	48	676050	139
651261	117	655946	63	658190	40	664970	49	676051	139
651524	93	655948	63	658190-TRI	40	664970	87	676070	138
651596	94	655950	63	658195	40	665102	52	676090	138
651901	131	655955	63	658195-TRI	40	665110	57	677102	52
651970	88	655956	63	658910	39	665110	99	677165	52
652201	223	655970	88	658920	39	665165	52	677180	52
652250	223	655976	88	658930	39	665180	52	677970	53
652260	223	655976-SIN	88	658940	39	665610	56	677970	88
652270	223	655980	64	658950	39	665610	97	677980	53
652290	223	655981	107	658970	38	665630	56	678101	78
653180	152	655983	64	658975	38	665630	97	678101-CF1	80
653190	152	655986	64	658980	41	665631	56	678101-EXF	79
654180	152	655990	134	658980	87	665631	97	678104	78
655000	145	655994	134	658985	41	665638	56	678104-CF1	80
655000-06	145	655997	134	658985	87	665638	97	678104-CF2	80
655001	145	656101	67	659180	152	665640	56	678104-EXF	79
655061	145	656101	138	659190	152	665640	97	678108	78
655073	61	656161	67	660160	37	665641	56	678108-CF1	80
655074	115	656161	138	660160-TRI	37	665641	97	678108-CF2	80
655075	115	656170	67	660175	37	665970	88	678108-EXF	79
655076	115	656170	138	660175-TRI	37	665980	53	678112	78
655077	115	656171	67	660190	40	667201	209	678112-CF1	80
655079	61	656171	138	660190-TRI	40	668102	210	678112-CF2	80
655080	145	656176	67	660960	38	669205	224	678112-EXF	79
655081	145	656176	138	660975	38	669215	224	678116	78
655083	61	656190	67	660980	41	669225	224	678116-CF1	80
655086	61	656190	138	660980	87	669225	224	678116-CF2	80
655087	62	656191	67	660985	41	669285	223	678116-EXF	79
655088	62	656191	138	660985	87	670102	158	678124	78
655090	62	656197	67	661160	37	670180	50	678124-CF1	80
655094	115	656197	138	661175	37	670190	50	678124-CF2	80
655095	115	656199	67	661190	40	671201	217	678124-EXF	79
655096	116	656199	138	661195	40	671221	218	678140	78
655097	116	657102	158	661195-TRI	40	671251	221	678140-CF1	80
655098	62	657110	57	661910	39	671271	221	678140-CF2	80
655101	115	657110	98	661920	39	671273	217	678140-EXF	79
655160	61	657160	52	661940	39	671274	217	678904	78
655161	115	657165	52	661950	39	671275	217	678908	78
655161	115	657185	52	661960	38	671276	217	678912	78
655162	61	657610	55	661975	39	671277	217	678916	78
655167	59	657610	96	661980	41	671281	217	678924	78
655169	59	657630	55	661980	88	673210	218	678940	78
655180	61	657630	96	661985	41	673271	218	680190	76
655182	61	657631	55	661985	88	673273	218	680195	76
655184	64	657631	96	662050	141	673274	218	680645	75
655185	64	657638	55	662145	141	673275	218	680648	75
655201	117	657638	96	662150	141	673276	218	680658	75
655209	117	657640	55	662610	57	673277	218	680660	75
655630	59	657640	96	662610	98	674201	220	680665	75
655640	59	657641	55	662630	57	674274	220	680668	75
655641	59	657641	96	662630	98	674275	220	681670	75

681672.....	75	710183.....	243	772354.....	234	781076.....	119	782086.....	66
681675.....	75	716201.....	209	772355.....	234	781077.....	119	782092.....	66
682201.....	217	716261.....	171	772361.....	234	781077-25.....	119	782093.....	66
682273.....	217	717201.....	209	772362.....	234	781079.....	65	782095.....	123
682274.....	217	722201.....	209	772363.....	234	781080.....	65	782096.....	123
682275.....	218	723201.....	170	772364.....	234	781086.....	65	782097.....	123
682276.....	218	723261.....	171	772365.....	234	781090.....	65	782101.....	123
682277.....	218	724411.....	176	773353.....	235	781091.....	65	782180.....	66
682281.....	218	724412.....	176	773363.....	235	781092.....	65	782261.....	127
682612.....	75	724413.....	176	774353.....	235	781093.....	65	782270.....	127
682615.....	75	724414.....	176	774363.....	235	781095.....	119	782855.....	129
682624.....	75	725201.....	209	775350.....	236	781096.....	119	782865.....	129
682625.....	75	725261.....	210	775351.....	236	781097.....	119	782900.....	132
682660.....	75	729101.....	210	775352.....	236	781098.....	65	782904.....	132
682670.....	75	730191.....	159	775353.....	236	781101.....	119	782946.....	67
682672.....	75	731101.....	159	775354.....	236	781162.....	119	782974.....	89
682678.....	75	731161.....	159	775355.....	236	781165.....	65	783076.....	123
683201.....	217	731165.....	159	775361.....	236	781182.....	65	783092.....	123
683271.....	217	731170.....	159	775362.....	236	781185.....	119	783096.....	123
683273.....	217	731171.....	159	775363.....	236	781186.....	119	783160.....	66
683274.....	217	731175.....	159	775364.....	236	781201.....	121	783892.....	111
683275.....	217	731180.....	159	775365.....	236	781201-906.....	121	784074.....	120
683276.....	217	731181.....	159	776350.....	237	781201-906.....	129	784075.....	120
683277.....	217	731185.....	159	776351.....	237	781207.....	121	784075-25.....	120
684201.....	218	745290.....	240	776352.....	237	781209.....	121	784076.....	120
688102.....	158	754061.....	147	776353.....	237	781261.....	121	784076-25.....	120
688161.....	158	754070.....	147	776354.....	237	781270.....	126	784077.....	120
690160.....	37	756001.....	147	776355.....	237	781271.....	127	784080.....	66
690160-TRI.....	37	756070.....	147	776361.....	237	781280.....	121	784086.....	66
690170.....	37	756071.....	147	776362.....	237	781281.....	121	784201.....	121
690175.....	37	760107.....	242	776363.....	237	781801.....	136	784209.....	120
690175-TRI.....	37	760160.....	242	776364.....	237	781830.....	92	784900.....	132
690190.....	40	760160-TRI.....	243	776365.....	237	781840.....	91	784904.....	132
690190-TRI.....	40	760180.....	242	777350.....	238	781841.....	92	784946.....	66
690195.....	40	762001.....	147	777351.....	238	781846.....	93	785285.....	223
690195-TRI.....	40	762061.....	147	777352.....	238	781850.....	92	785290.....	223
690910.....	39	762070.....	147	777354.....	238	781856.....	111	786201.....	126
690920.....	39	762071.....	147	777355.....	238	781866.....	109	786261.....	126
690940.....	39	762074.....	147	777361.....	238	781892.....	111	787979.....	88
690950.....	39	762075.....	147	777362.....	238	781899.....	132	788095.....	120
690975.....	38	762076.....	147	777364.....	238	781901.....	131	788096.....	120
690980.....	41	762077.....	147	777365.....	238	781903.....	132	788101.....	120
690980.....	87	767001.....	147	778350.....	238	781904.....	131	788876.....	136
690985.....	41	767070.....	147	778351.....	239	781906.....	132	789866.....	109
690985.....	87	767071.....	147	778352.....	239	781930.....	65	789979.....	89
691101.....	67	768160.....	242	778353.....	239	781936.....	65	792870-906.....	129
691101.....	138	768160-TRI.....	243	778354.....	239	781940.....	65	792891.....	67
691161.....	67	768180.....	242	778355.....	239	781944.....	65	792891.....	138
691161.....	138	769190.....	152	778361.....	239	781946.....	65	793855.....	129
692201.....	170	770310.....	239	778362.....	239	781948.....	65	802202.....	190
692261.....	171	770320.....	239	778363.....	239	781950.....	65	802203.....	190
693201.....	170	770330.....	239	778364.....	239	781956.....	65	802204.....	190
700361.....	244	770340.....	239	778365.....	239	781970.....	88	802206.....	190
700370.....	244	770370.....	239	779160.....	41	781974.....	88	802212.....	189
701070.....	147	770380.....	239	779190.....	42	781976.....	88	802216.....	189
701071.....	147	771350.....	233	780201.....	125	781976-SIN.....	88	802225.....	190
705063.....	148	771351.....	233	780210.....	125	781983.....	65	802501.....	189
705065.....	148	771352.....	233	780215.....	126	781986.....	65	802506.....	193
705066.....	148	771353.....	233	780261.....	125	781990.....	134	802576.....	193
705070.....	148	771354.....	233	780270.....	126	781995.....	134	803202.....	193
705071.....	148	771355.....	233	780271.....	126	781996.....	134	803270.....	193
705073.....	148	771361.....	233	780285.....	126	781997.....	134	828210.....	190
705074.....	148	771362.....	233	780286.....	126	782061.....	123	843060.....	249
705075.....	148	771363.....	233	781061.....	119	782073.....	66	844060.....	250
705076.....	148	771364.....	233	781061-25.....	119	782074.....	123	845060.....	250
705092.....	148	771365.....	233	781073.....	65	782075.....	123	846060.....	249
710107.....	242	772350.....	234	781074.....	119	782076.....	123	847060.....	244
710160.....	242	772351.....	234	781074-25.....	119	782077.....	123	848060.....	251
710160-TRI.....	243	772352.....	234	781075.....	119	782078.....	66	848902.....	251
710180.....	242	772353.....	234	781075-25.....	119	782080.....	66	848913.....	251

848915	251	978570	200	96077307	50
848916	251	978580	200	BAG1	43
848921	251	978583	200	BAG1	160
848923	251	978584	200	BAG2	43
848950	251	978585	200	BAG2	44
849080	204	978586	200	BAG2	160
849081	203	978587	200	BAG3	43
849082	202	978588	200	BAG3	44
852076-UK....	202	978589	200	BAG3	160
852078-UK....	202	999201	181	N1938	45
878071	82	999202	181	N1950	45
878072	81	999203	181	N2138	45
878073	81	999204	181	N2316	45
878074	81	999205	181	N2325	45
878075	82	999206	181	N2332	45
950700	42	999207	181	N2516	45
951700	42	999208	181	N2525	45
952700	42	999209	181	SYR1	45
960161	177	999231	180	SYR2-5	45
960177	178	999232	180	SYR5	45
968177	177	999234	180	SYR10	45
975270	125	999235	180	SYR20	45
975271	125	999236	180	SYR30	45
975275	125	999237	180	SYR50	45
975502	126	999238	180	SYR50LS	45
976501	201	999239	180		
976561	195	999241	179		
976563	195	999242	179		
976564	195	999244	179		
976565	195	999245	179		
976566	195	999246	179		
976567	195	999248	179		
976568	195	999250	179		
976569	195	999251	179		
976570	196	999252	179		
976580	196	999254	179		
976583	196	999255	179		
976584	196	999257	179		
976585	196	999291	180		
976586	196	999292	180		
976587	196	999293	180		
976588	196	999294	180		
976589	196	999295	180		
977501	201	999296	181		
977561	197	999297	180		
977563	197	999298	180		
977564	197	89000002	229		
977565	197	89000010	229		
977566	197	89000020	229		
977567	197	89000098	231		
977568	197	89000099	230		
977569	197	89000100	229		
977570	198	89000200	229		
977580	198	89000500	229		
977583	198	89000810	229		
977584	198	89000820	229		
977585	198	89001000	229		
977586	198	89001210	230		
977587	198	89001220	230		
977588	198	89008200	230		
977589	198	89008300	230		
978501	202	89010000	229		
978561	199	89012200	230		
978563	199	89012300	230		
978564	199	89019801	231		
978565	199	89019803	231		
978566	199	89019804	231		
978567	199	89019805	231		
978568	199	89019806	231		
978569	199	89019809	231		

GLOSSARY

1536 Well Microplates	123,127,129,131
2 ml aspiration pipette.....	243
24 Well ComboPlate.....	141
384 Well Microplates.....	119,120,121,126,129,131,134,136
384 Well PCR Microplates	223
3D Cell Culture	87,91,92,93,94
48-way Datamatrix Cryo Rack	193
81-way Datamatrix Cryo Rack	193
96 Well ELISA Microplates	145
96 Well ELISA Strip Plates	147,148
96 Well Microplates.....	115,116,117,125,131,134,136
96 Well PCR Microplates	223
96 Well Storage Box.....	126
96-way Datamatrix Cryo Rack	201
Advanced TC.....	52,53
Analyser Cups.....	210
AutoFlask - Cell Culture Flask.....	41,42
Bacteriology	157,158
Biobanking Tubes	201
CELLCOAT®	39,53
CELLdisc	78,79,80
CELLlevator.....	82
CELLhandle.....	81
CELLreactor.....	69,170
CELLring	82
CELLstage.....	81
CELLview Dish.....	49,50,103
CELLview Plate.....	107
CELLview Slide.....	105
CapMats.....	139
Ceaprene stopper	178
Cell Culture	34,35
Cell Culture Dishes	47
Cell Culture Dishes - Advanced TC.....	47,48
Cell Culture Dishes - CELLCOAT®	48
Cell Culture Dishes - Cell-Repellent Surface	49,87
Cell Culture Flasks.....	36,37,41,42,87
Cell Culture Flasks - Advanced TC	38,39
Cell Culture Flasks - CELLCOAT®.....	39
Cell Culture Inserts.....	55,56,57,96,97,98
Cell Culture Microplates	65,66,88
Cell Culture Multiwell Plates	52,53
Cell Culture Roller Bottles	74,75,76
Cell Culture Tubes.....	69
Cell Scraper	42
Cell Strainer.....	71
Cell-Repellent Surface.....	41,53,87,88,89
Contact Dishes	158
Containers for Plant Cultures	177
Cryo Tubes.....	185,187,188
Cryo storage box.....	190
Cryo.s	185,187,188,189,190
Cryo.s Biobanking Tubes sterile	201
Cryo.s with Barcode	192,193
CrystalBridge	141
CrystalQuick	141
CrystalQuick Plus.....	141
Datamatrix coded Cryo.s tubes	192,193
Datamatrix rack for cryo tubes.....	193
Disposable Inoculation Loops / Needles	159
Disposal Bags	43,160
Drosophila Containers.....	178
EASYstrainer Cell Strainers.....	71
ELISA Microplates	145
ELISA Strip Plates	147,148
FourWell Plate	50
Glass Bottom Microplates.....	111
Grip stopper.....	166
HTS-Microplates	115,116,117,119,120,121,123
Immuno Tubes	150
Inserts for Mini Block Heater	251
Lab Equipment	249,250,251
Leucosep.....	174
Lids.....	138
Lids / Sealers / CapMats	138,139
MASTERBLOCK®	125,126,127
Macro Pipette Tip	240
MagPen.....	93
Magnetic 3D Cell Culture.....	91,92,93,94
Magnetic Levitation.....	92
Mass Cell Culture	75
MaxiPette	244
Microbiology	157,158
Microplate Centrifuge	249
Microplates.....	115,116,117,119,120,121,123
Microplates for Compound Storage.....	129
Mini Block Heater.....	251
Mini Centrifuge	249
Mini Vortex Mixer	250
Molecular Biology	217,218,219,220,223
Multi-Channel Pipettes.....	229,230
Multipurpose Containers / Beakers	176,177
Multiwell Plates.....	52,53,88
Non-binding Microplates	131
OncoQuick®.....	174
OneWell Plate	50
PCR 8-Tube Strips.....	218
PCR Microplates	223
PCR Tubes.....	217,218,219,220
Pasteur / Serum Pipettes	244
Petri Dishes	157,158
Pipette Carousel	230
Pipette Tips	233,234,235,236,237,238,239,240
Pipettes.....	229,230
Polypropylene Tubes	165,166,170
Polystyrene Tubes.....	165,171,172
Polystyrene drosophila containers	178
Products for Microscopy	103,105,107,109,111
Protein Crystallisation Plates.....	141
Rack for pipette tips	239
Reaction Tubes.....	209,210,217,218
Roller Bottles.....	74,75,76
SCREENSTAR Microplates.....	89,109
Sapphire PCR 8-Cap Strips.....	219,220
Sapphire Pipette Tips.....	229,233,234,235,236,237,238,239
Sapphire Pipettes.....	229,230
Screening	93
Screw Caps.....	201,210
Sealers	138,139
Semi-micro / Macro Cuvette.....	212

SensoPlate	111	Cell Culture Inserts	58,59,60,100,101,102
Separation Tubes	174	Cell Culture Microplates	69,70,92
Serological Pipettes	242,243	Cell Culture Multiwell Plates	54,55,56
Single-Channel Pipettes	229	Cell Culture Roller Bottles	78,79,80
Single-break Strip Plates	148	Cell Culture Tubes.....	73
Streptavidin-coated microplates.....	134	Cell Scraper	45
Support Rack.....	189	Cell Strainer.....	75
Suspension Culture Flasks	40	Cell-Repellent Surface	44,56,91,92,93
		Contact Dishes	173
Terasaki Plates	152	Containers for Plant Cultures	192
ThinCert®.....	58,96,97,98	Cryo Tubes.....	197,199,200
ThinCert® Cell Culture Inserts	55,56,57	Cryo storage box.....	201
ThinCert® Plate.....	57,98	Cryo.s	197,199,200,201
Transfer Pipettes.....	244	Cryo.s Biobanking Tubes sterile	212
Triple Packed Products	37,47,243	Cryo.s Rack Scanner.....	214
Tube	69	Cryo.s with Barcode	203,204
Tubes / Multipurpose Beakers	165,170,171,172,176,177,178	CrystalBridge	152,153
Two-position Cap	172	CrystalQuick	152
		CrystalQuick Plus.....	152
UV-Star® Microplates	136		
		Datamatrix coded Cryo.s tubes	203,204
Vortex Mixer.....	250	Datamatrix rack for cryo tubes	204
		Disposable Inoculation Loops / Needles	175
inoculation loop	159	Disposal Bags	47,176
inoculation needle.....	159,153,156	Drosophila Containers.....	192
159,153,156 Well Microplates	135,138,140,142		
2 ml aspiration pipette.....	248	EASYstrainer Cell Strainers.....	75
24 Well ComboPlate.....	152,153	ELISA Microplates	161
384 Well Microplates.....	131,132,138,140,142,145,147	ELISA Strip Plates	163,164
384 Well PCR Microplates	231		
3D Cell Culture	91,95,96,97,98	FourWell Plate	52
48-way Datamatrix Cryo Rack	204		
81-way Datamatrix Cryo Rack	204	Gel-Load Pipette Tips.....	245
96 Well ELISA Microplates	161	Glass Bottom Microplates.....	119
96 Well ELISA Strip Plates	163,164	Grip stopper.....	182
96 Well Microplates.....	127,128,129,137,142,145,147		
96 Well PCR Microplates	231	HTS-Microplates	127,128,129,131,132,135
96 Well Storage Box.....	137		
96-way Datamatrix Cryo Rack	212	Immuno Tubes	166
		Inserts for Mini Block Heater	255
Advanced TC.....	54,55		
Analyser Cups.....	220	Lab Equipment	253,254,255
AutoFlask - Cell Culture Flask.....	44,45	Leucosep.....	189
		Lids.....	71,149
Bacteriology	173,174,175	Lids / Sealers / CapMats	149,150
Biobanking Tubes	212		
		MASTERBLOCK®	137,138
CELLCOAT®	42,55	Macro Pipette Tip	245
CELLdisc	82,83,84	MagPen	97
CELLlevator.....	86	Magnetic 3D Cell Culture.....	95,96,97,98
CELLhandle.....	85	Magnetic Levitation.....	96
CELLreactor.....	73,186	Mass Cell Culture	79
CELLring	86	MaxiPette	249
CELLstage.....	85	Microbiology	173,174,175
CELLview Dish	51,52,111	Microplate Centrifuge	253
CELLview Plate.....	115	Microplates.....	127,128,129,131,132,135
CELLview Slide.....	113	Microplates for Compound Storage.....	140
CapMats.....	150	Mini Block Heater	255
Ceaprene stopper.....	193	Mini Centrifuge	253
Cell Culture	34,35,36,37,38,39,124	Mini Vortex Mixer	254
Cell Culture Dishes	49	Molecular Biology	227,228,229,231
Cell Culture Dishes - Advanced TC.....	49,50	Multi-Channel Pipettes.....	235,236
Cell Culture Dishes - CELLCOAT®	50	Multipurpose Containers / Beakers.....	191,192
Cell Culture Dishes - Cell-Repellent Surface	51,91	Multiwell Plates.....	54,55,56,92
Cell Culture Flasks.....	40,41,44,45,91		
Cell Culture Flasks - Advanced TC	42	Non-binding Microplates	142
Cell Culture Flasks - CELLCOAT®	42		

OncoQuick®.....	189
OneWell Plate	52
PCR 8-Tube Strips.....	228
PCR Microplates	231
PCR Tubes.....	227,228,229
Pasteur / Serum Pipettes	249
Petri Dishes	173,174
Pipette Carrousel	236
Pipette Tips	238,239,240,241,242,243,244,245
Pipettes.....	235,236
Polypropylene Tubes	181,182,186
Polystyrene Tubes	181,186,187
Polystyrene drosophila containers	192
Products for Microscopy	111,113,115,117,119
Protein Crystallisation Plates.....	152
Rack for pipette tips	244
Reaction Tubes.....	219,220,227,228
Roller Bottles.....	78,79,80
SCREENSTAR Microplates.....	93,117
Sapphire PCR 8-Cap Strips.....	229
Sapphire Pipette Tips.....	235,238,239,240,241,242,243,244
Sapphire Pipettes.....	235,236
Screening	97
Screw Caps.....	212,220
Sealers	149,150
Semi-micro / Macro Cuvette.....	222
SensoPlate	119
Separation Tubes	189
Serological Pipettes	247,248
Single-Channel Pipettes	235
Single-break Strip Plates	164
Streptavidin-coated microplates.....	145
Support Rack.....	200
Suspension Culture Flasks	43
Swab Tube	175
Terasaki Plates	168
ThinCert®.....	62,100,101,102
ThinCert® Cell Culture Inserts	58,59,60
ThinCert® Plate.....	60,102
Transfer Pipettes.....	249
Triple Packed Products	41,49,248
Tube.....	73
Tubes / Multipurpose Beakers	181,186,187,191,192
Two-position Cap	187
UV-Star® Microplates	147
Vortex Mixer.....	254
inoculation loop	175
inoculation needle	175

making a difference

making a difference

www.gbo.com

GREINER BIO-ONE GMBH
FRICKENHAUSEN, GERMANY

PHONE +49 7022 948-0
FAX +49 7022 948-514
E-MAIL info@de.gbo.com



GREINER BIO-ONE IS A GLOBAL PLAYER.
FIND THE CONTACT DETAILS OF YOUR
LOCAL PARTNER ON OUR WEBSITE.



Devices of Greiner Bio-One are to be used by properly qualified persons only in accordance with the relevant Instructions for Use (IFU), where applicable.
For more information contact your local Greiner Bio-One sales representative or visit our website (www.gbo.com).

All information is provided without guarantee despite careful processing. Any liability, warranty or guarantee of Greiner Bio-One GmbH is excluded. All rights, errors and changes are reserved. If not stated otherwise, Greiner Bio-One GmbH has all copyrights and/or other (user-)rights in this documents, in particular to signs such as the mentioned (word-picture-) brands and logos. Any use, duplication or any other use of the rights of Greiner Bio-One GmbH is expressly prohibited.

Media owner: Greiner Bio-One GmbH / Represented by Managing Director Bernd Klingel.
The company is registered in the Commercial Register at the first instance court in Stuttgart, HRB 224604 / VAT Number: DE812585719.

F071075 EN [2024]

greiner
BIO-ONE